



**DENTAL INSTRUMENTS CATALOG**



## Table of Contents

<b>01</b>	Tooth Extracting Forceps		<b>01-49</b>
<b>02</b>	Root Elevators		<b>50-70</b>
<b>03</b>	Scalpel Handles, Handles, Mouth Mirrors Scalers, Explorer / Probes		<b>71-85</b>
<b>04</b>	Endodontic Condensers, Obturation Instruments Excavators, Explorer / Probes, Curette Sets		<b>86-96</b>
<b>05</b>	Amalgam Pluggers / Condensers, Burnishers		<b>97-100</b>
<b>06</b>	Wax Carvers, Carvers, Chisels		<b>101-103</b>
<b>07</b>	Compsite Placement, Plastic Filling Instruments		<b>104-107</b>
<b>08</b>	Curettes, Gracey Curettes, Dental Products, Knives		<b>108-117</b>



## Table of Contents

<b>09</b>	Wax Porcelain & Cement Instruments Wax & Modeling Instruments		<b>118-121</b>
<b>10</b>	Spatulas, Cement Spatulas		<b>122-124</b>
<b>11</b>	Files, Hoes, Knives, Wax & Plaster Knives, Crane Kaplan		<b>125-128</b>
<b>12</b>	Bone Curettes, Bone Files, Bone Chisels, Bone Mallets		<b>129-133</b>
<b>13</b>	Crown Removers, Crown Instruments		<b>134-136</b>
<b>14</b>	Implants & Measuring Instruments, Suction Tubes, Bone Gauges		<b>137-144</b>
<b>15</b>	Amalgam Guns & Carriers, Retainers, Bands, Strip Holders, Napkin Holders		<b>145-146</b>
<b>16</b>	Rubber Dam Instruments, Rubber Dam Clamps		<b>147-148</b>



## Table of Contents

<b>17</b>	Syringes, Tweezers, Sterilizing & Lab Instruments		<b>149-156</b>
<b>18</b>	Endodontic Forceps, Tissue Forceps, Haemostatic Forceps, Towel Clamps		<b>157-159</b>
<b>19</b>	Retractors, Lip & Cheek Retractors, Hooks, Depressors & Mouth Gags, Sterilizing Forceps		<b>160-164</b>
<b>20</b>	Orthodontic Pliers & Cutters, Rongeurs		<b>165-179</b>
<b>21</b>	Needle Holders, Scissors, Micro Surgery Set		<b>180-186</b>
<b>22</b>	Impression Trays		<b>187-193</b>
<b>23</b>	Articulators, Hollow Wares		<b>194-200</b>
<b>24</b>	Scissors, Dissecting Forceps, Needle Holders, Wire Cutting Pliers With Tungsten Carbide Inserts		<b>201-213</b>



TOOTH EXTRACTING FORCEPS



## Extracting Forceps "English Pattern"



**1001**  
Fig. 4  
lower incisor



**1001**  
Fig. 4  
lower incisor



**1002**  
Fig. 8  
lower premolar



**1002**  
Fig. 4  
lower incisor



## Extracting Forceps “English Pattern”



**1003**  
Fig. 1  
upper entrals & canines



**1004**  
Fig. 2  
upper entrals & canines



**1005**  
Fig. 3  
upper entrals & canines



**1006**  
Fig. 4  
upper entrals & canines



**1007**  
Fig. 7  
upper premolars



**1008**  
Fig. 8  
lower premolars



**1009**  
Fig. 13  
lower premolars



## Extracting Forceps “English Pattern”



**1010**  
Fig. 13S  
lower premolars  
for children

**1011**  
Fig. 17  
upper molars, right

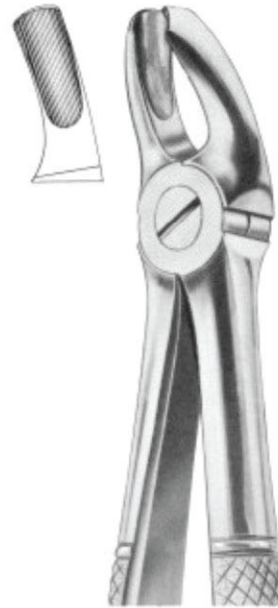

**1012**  
Fig. 18  
upper molars, left

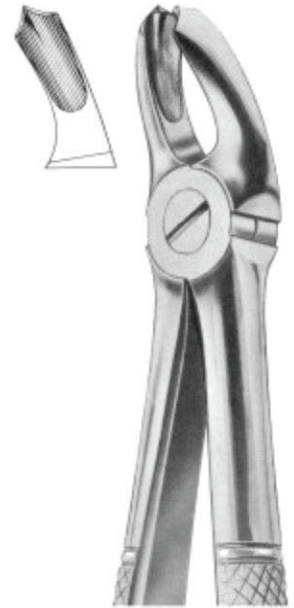

**1013**  
Fig. 18A  
upper molars

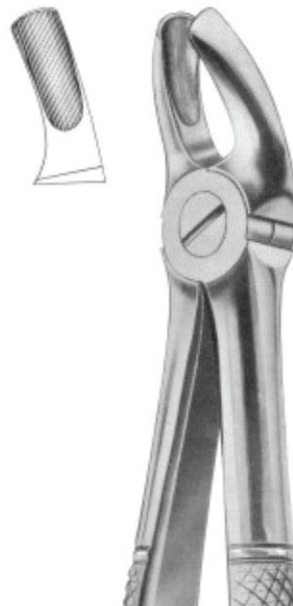

**1014**  
Fig. 18B  
upper molars



**1015**  
Fig. 19  
upper third molars





## Extracting Forceps “English Pattern”



**1016**  
Fig. 20  
upper third molars

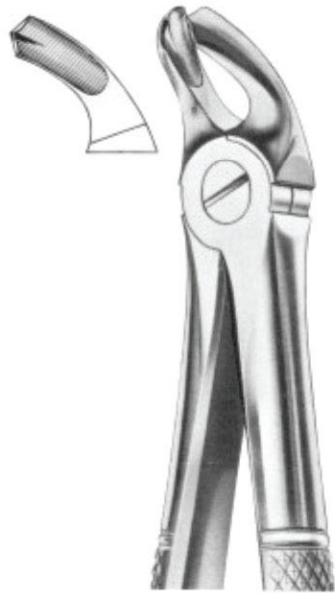

**1017**  
Fig. 21  
upper molars



**1018**  
Fig. 22  
lower molars



**1019**  
Fig. 22S  
lower premolars  
for children

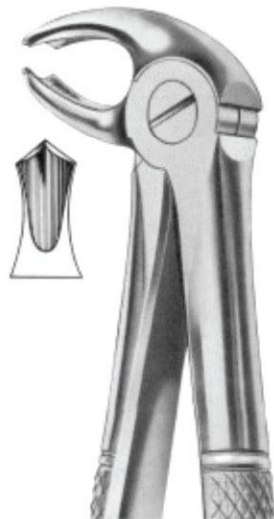

**1020**  
Fig. 22G  
lower molars



**1021**  
Fig. 23  
lower molars, right



**1024**  
Fig. 24  
lower molars, right



## Extracting Forceps "English Pattern"



**1023**  
Fig. 29  
upper roots



**1024**  
Fig. 29S  
upper roots for children



**1025**  
Fig. 30  
upper molars

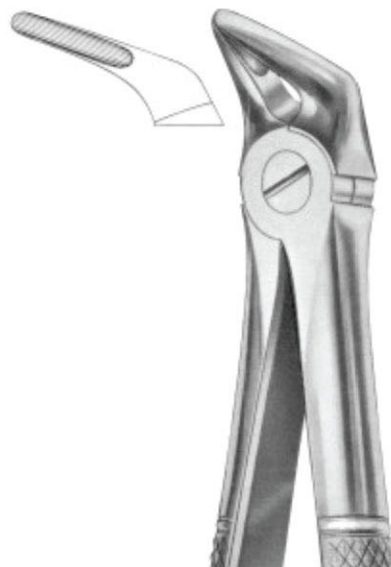

**1026**  
Fig. 31  
lower roots



**1027**  
Fig. 32  
lower molars



**1019**  
Fig. 30S  
upper roots  
for children



## Extracting Forceps “English Pattern”



**1029**  
Fig. 33  
lower roots



**1030**  
Fig. 33A  
lower roots



**1031**  
Fig. 33B  
lower roots



**1034**  
Fig. 33S  
lower roots  
for children

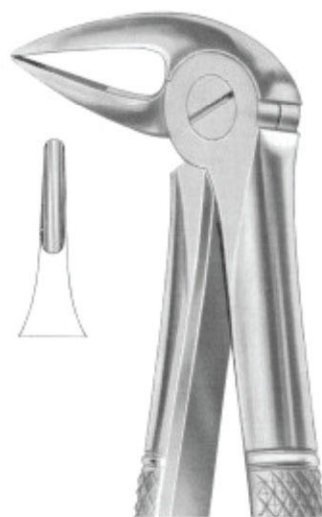

**1032**  
Fig. 33L  
lower roots



**1033**  
Fig. 37  
upper roots  
for children



# Extracting Forceps "English Pattern"



**1035**  
Fig. 38  
lower incisors &  
canines for children



**1036**  
Fig. 37  
upper molars  
for children



**1133**  
Fig. 37  
upper roots  
for children

**1037**  
Fig. 39R  
upper molars right  
for children



**1040**  
Fig. 39L  
upper molars right  
for children



**1038**  
Fig. 39A  
upper molars  
for children



**1339**  
Fig. 40  
lower molars  
for children



# Extracting Forceps "English Pattern"



**1041**  
Fig. 41  
upper roots



**1042**  
Fig. 44  
upper roots



**1043**  
Fig. 45  
lower roots

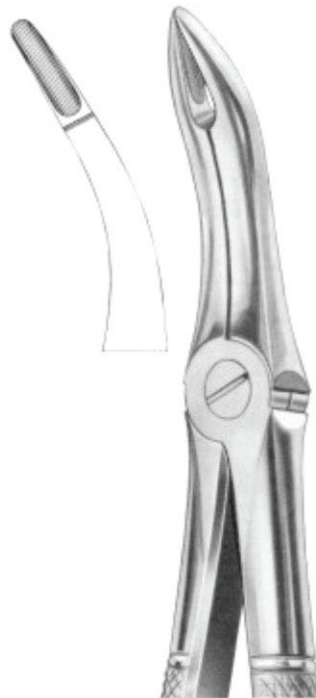

**1044**  
Fig. 48  
lower roots

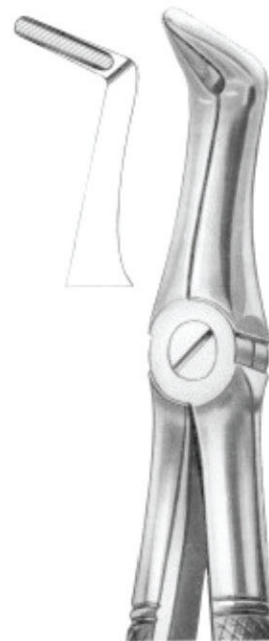

**1045**  
Fig. 49  
upper roots



**1046**  
Fig. 50  
upper roots



## Extracting Forceps “English Pattern”

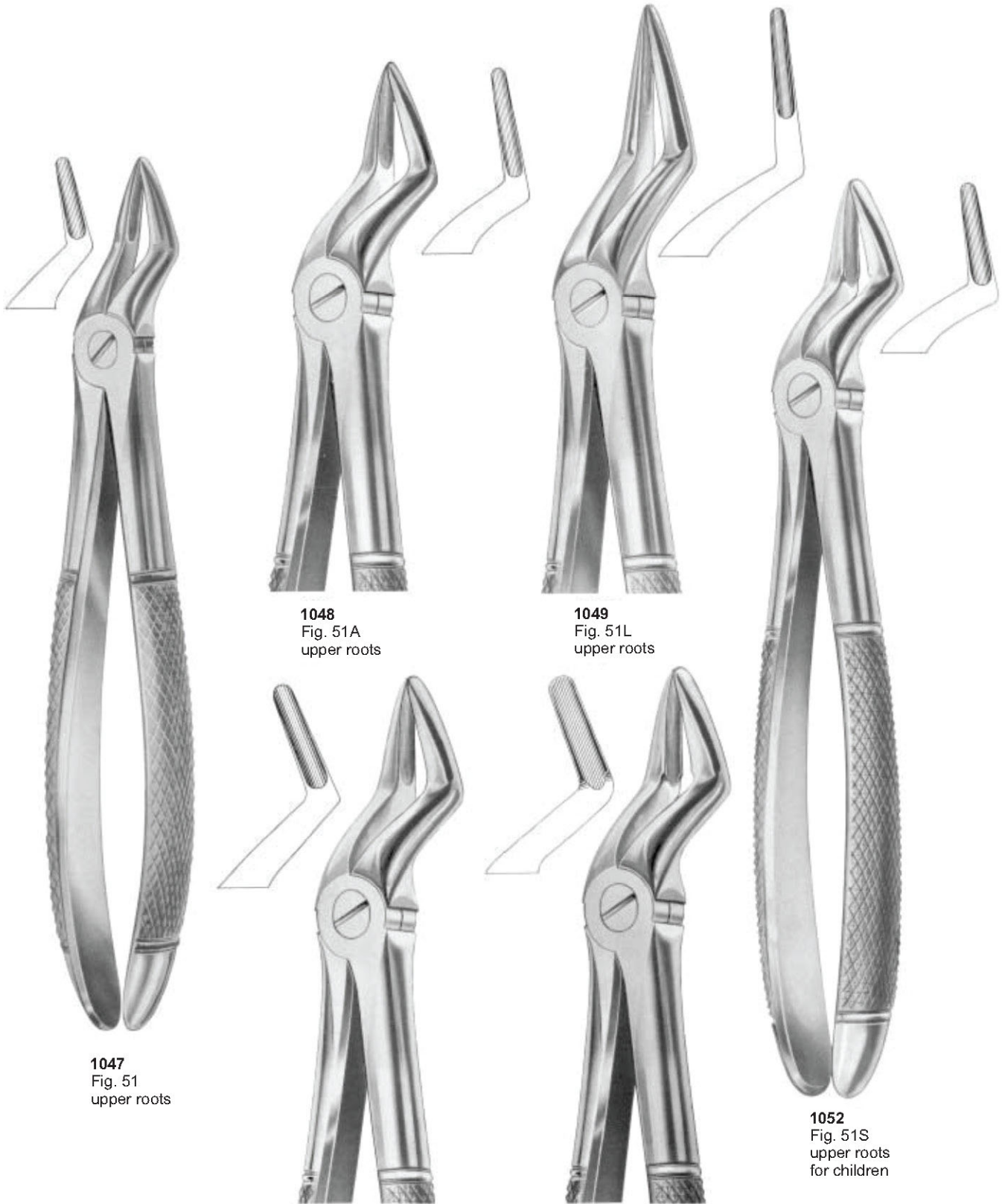

**1047**  
Fig. 51  
upper roots

**1048**  
Fig. 51A  
upper roots

**1049**  
Fig. 51L  
upper roots

**1050**  
Fig. 52  
upper roots

**1051**  
Fig. 52A  
upper teeth  
and resection

**1052**  
Fig. 51S  
upper roots  
for children



## Extracting Forceps "English Pattern"



**1052**  
Fig. 54  
for separating  
upper roots



**1054**  
Fig. 55  
for separating  
upper molars



**1055**  
Fig. 56  
for separating  
lower molars

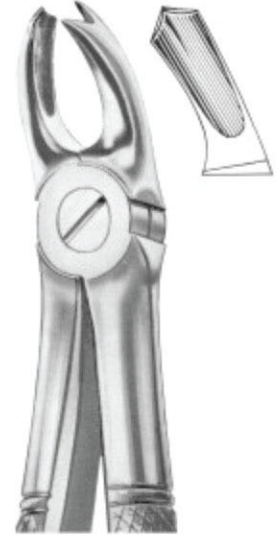

**1055**  
Fig. 65R  
upper molars  
right



**1057**  
Fig. 65L  
upper molars left



**1058**  
Fig. 67  
upper third molars

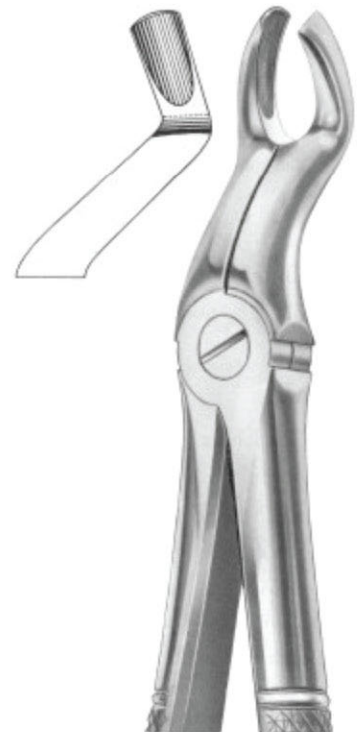

**1059**  
Fig. 67A  
upper third molars



## Extracting Forceps "English Pattern"



**1060**  
Fig. 65 1/2R  
upper third molars  
right



**1061**  
Fig. 67 1/2L  
upper third molars  
right



**1062**  
Fig. 68  
lower roots



**1063**  
Fig. 68A  
lower roots



**1064**  
Fig. 73  
lower molars



**1065**  
Fig. 73R  
lower molars right



**1066**  
Fig. 73L  
lower molars right





## Extracting Forceps “English Pattern”



**1067**  
Fig. 73A  
lower molars

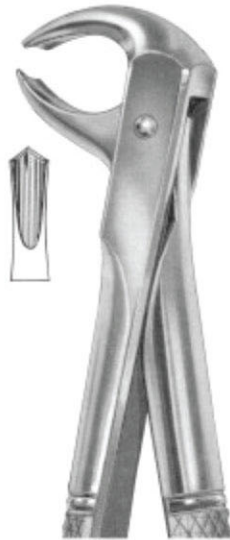

**1068**  
Fig. 73S  
lower molars



**1069**  
Fig. 73B  
lower molars for children



**1072**  
Fig. 73K  
lower molars  
for children



**1070**  
Fig. 74  
lower molars

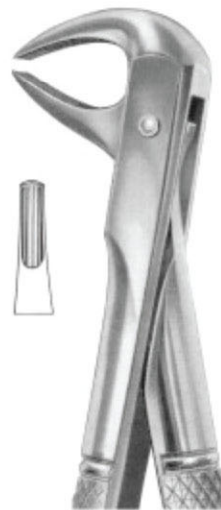

**1071**  
Fig. 74D  
lower roots



## Extracting Forceps “English Pattern”



**1073**  
Fig. 74M  
lower roots

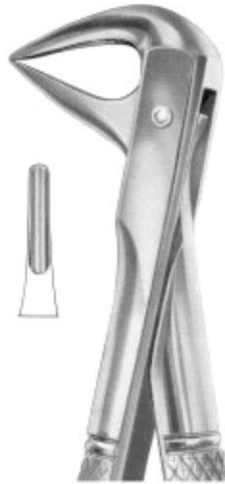

**1074**  
Fig. 74N  
lower roots



**1072**  
Fig. 73K  
lower roots and  
crowded incisors



**1078**  
Fig. 76N  
upper roots

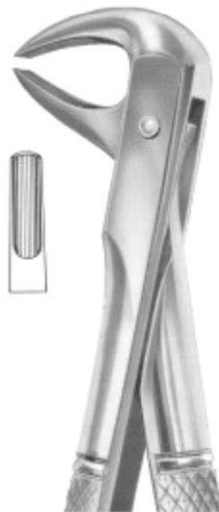

**1076**  
Fig. 75  
lower premolars



**1077**  
Fig. 76  
upper roots



## Extracting Forceps “English Pattern”



**1079**  
Fig. 76S  
upper roots



**1080**  
Fig. 79  
lower third molars



**1081**  
Fig. 79A  
lower third molars



**1082**  
Fig. 81  
lower premolars  
and roots



## Extracting Forceps “English Pattern”



**1083**  
Fig. 86A  
lower molars



**1084**  
Fig. 86B  
lower molars



**1085**  
Fig. 86C  
lower molars



**1086**  
Fig. 87  
lower molars



**1087**  
Fig. 91  
for separating  
lower molars

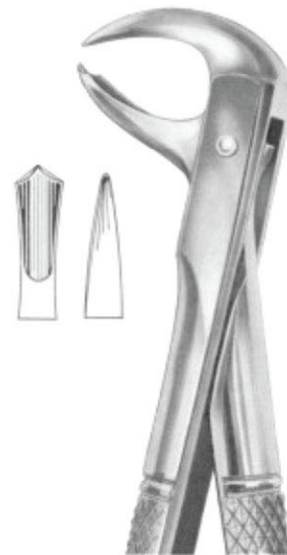

**1088**  
Fig. 99  
lower molars



## Extracting Forceps "English Pattern"



**1089**  
Fig. 101  
upper premolars  
and roots



**1090**  
Fig. 100  
upper roots



**1091**  
Fig. 99 1/4  
lower molars



**1092**  
Fig. 99 1/2  
lower molars



## Extracting Forceps “English Pattern”



**1093**  
Fig. 102  
upper molars right



**1094**  
Fig. 103  
upper molars right



**1095**  
Fig. 105  
lower incisors



**1096**  
Fig. 106  
lower incisors



**1096**  
Fig. 103  
upper canines



## Extracting Forceps "English Pattern"



**1098**  
Fig. 112  
upper roots



**1099**  
Fig. 113  
upper roots



**1100**  
Fig. 136  
upper premolars  
and roots

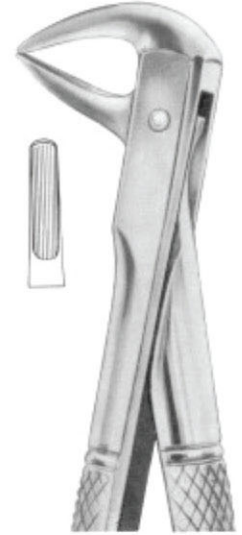

**1102**  
Fig. 137  
lower premolars  
and roots

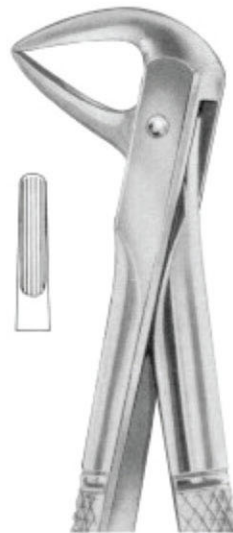

**1100**  
Fig. 114  
upper roots



**1103**  
Fig. 143  
lower roots



## Extracting Forceps "English Pattern"

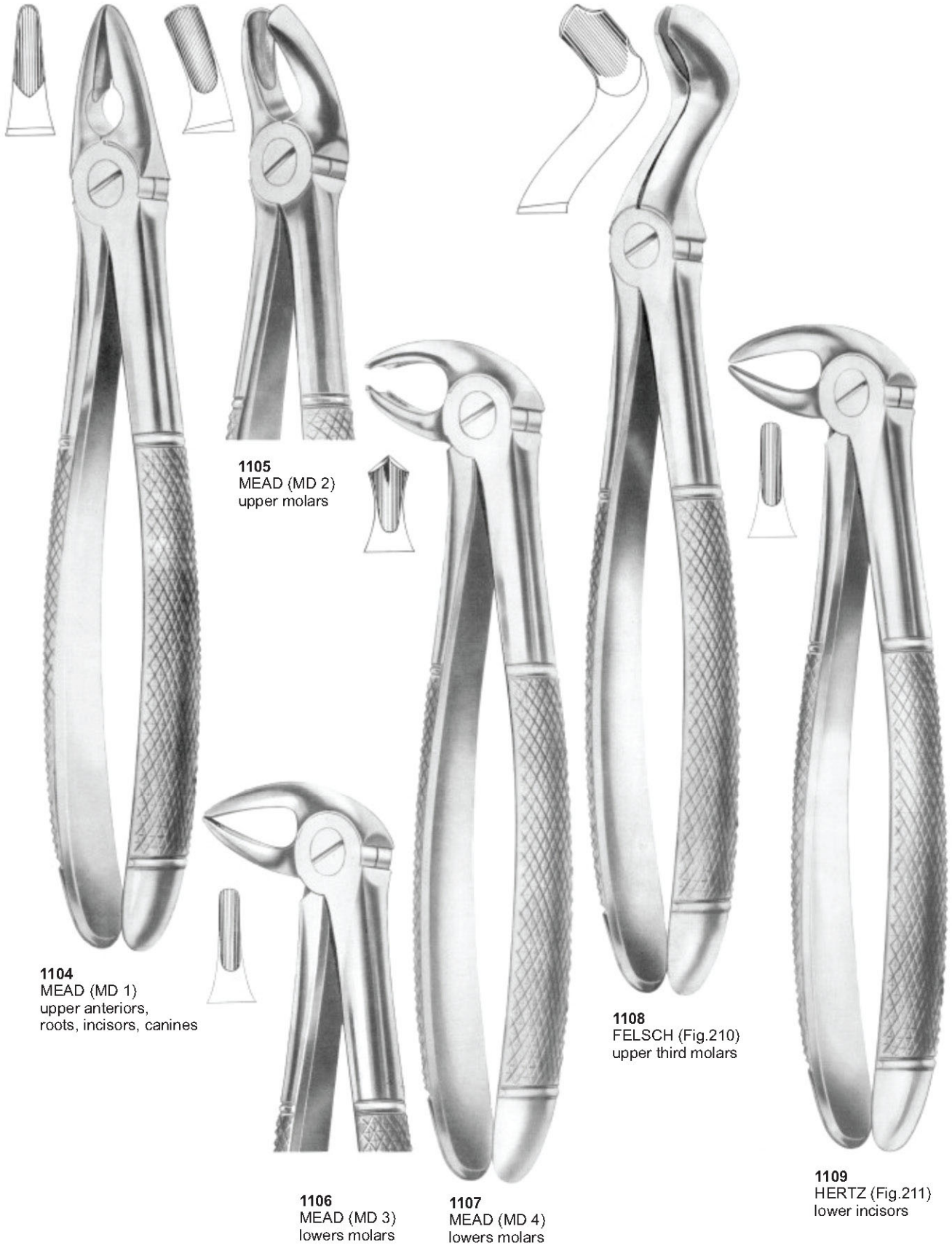

**1104**  
MEAD (MD 1)  
upper anteriors,  
roots, incisors, canines

**1105**  
MEAD (MD 2)  
upper molars

**1106**  
MEAD (MD 3)  
lowers molars

**1107**  
MEAD (MD 4)  
lowers molars

**1108**  
FELSCH (Fig.210)  
upper third molars

**1109**  
HERTZ (Fig.211)  
lower incisors





## Wisdom Extracting Forceps



**1110**  
ROUTURIER (Fig.212)  
(22 1/2L)  
lower molars  
and wisdom left



**1111**  
ROUTURIER (Fig.213)  
(22 1/2R)  
lower molars  
and wisdom left



**1112**  
ROUTURIER (Fig.214)  
(22 1/2L)  
lower molars  
and wisdom left



**1112**  
ROUTURIER (Fig.215)  
(33 1/2R)  
lower molars  
and wisdom left



**1114**  
RESECTION FORCEPS  
(216/Witzel)  
upper roots



## Extracting Forceps “English Pattern”



1115  
Fig. 5



1116  
Fig. 6

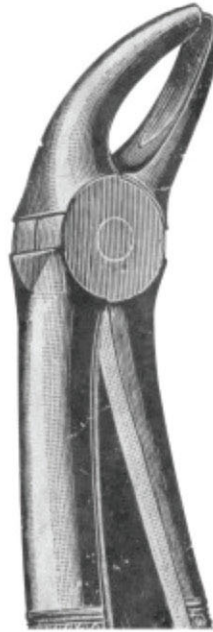

1117  
Fig. 9



1118  
Fig. 10



1121  
Fig. 14



1122  
Fig. 15





## Extracting Forceps “English Pattern”



1123  
Fig. 25



1124  
Fig. 26

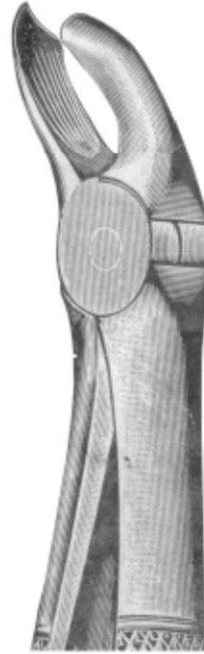

1125  
Fig. 27

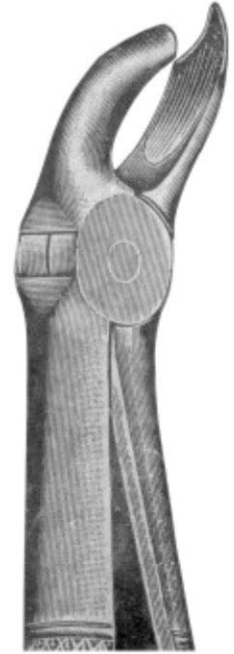

1126  
Fig. 28

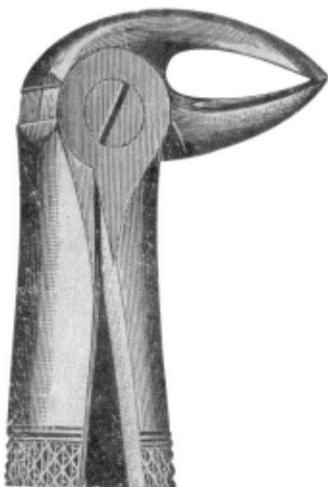

1127  
Fig. 34



1128  
Fig. 35

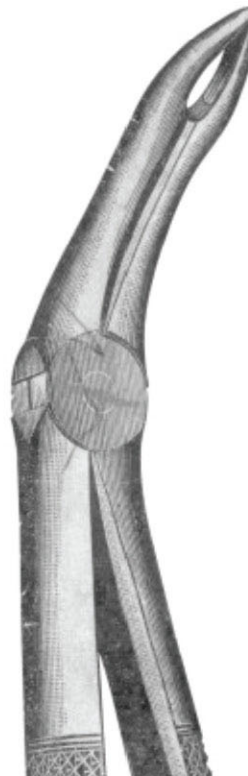

1129  
Fig. 42

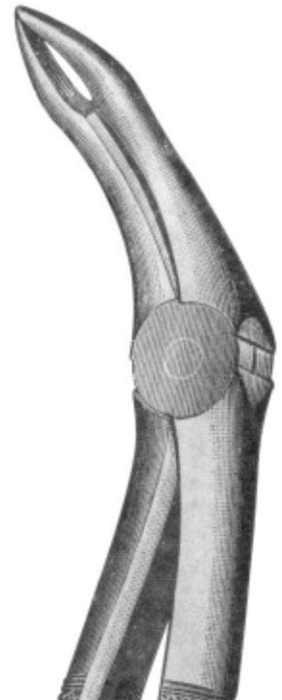

1130  
Fig. 43



## Extracting Forceps "English Pattern"



1131  
Fig. 44A

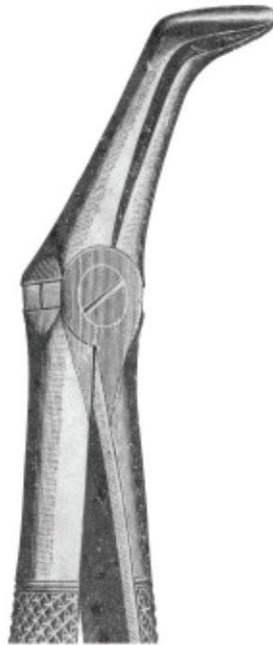

1132  
Fig. 46

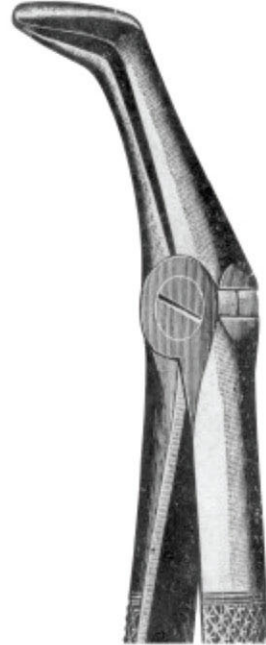

1133  
Fig. 47

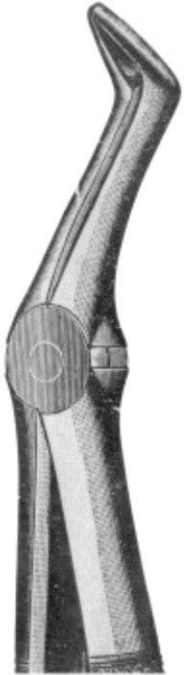

1134  
Fig. 50A



1135  
Fig. 74R



1136  
Fig. 74L

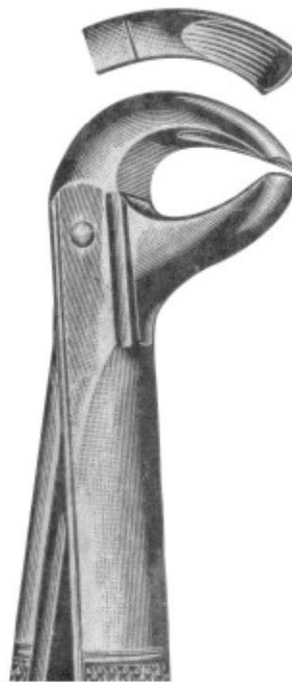

1137  
Fig. 75R



1138  
Fig. 75L



### Extracting Forceps "English Pattern"

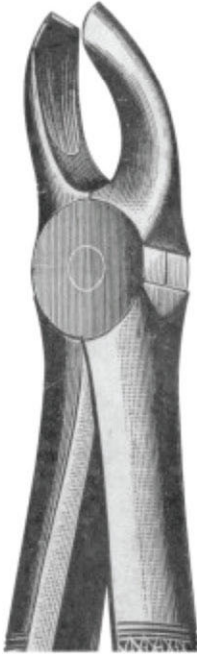

1139  
Fig. 94

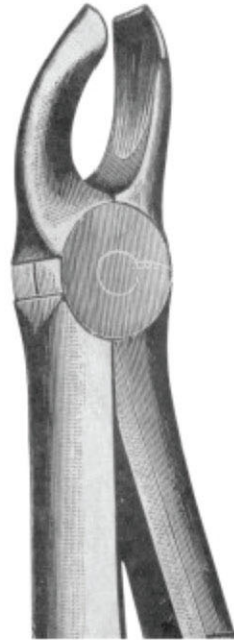

1140  
Fig. 95



1141  
Fig. 98

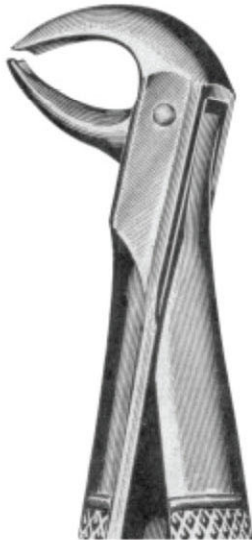

1142  
Fig. 105



1143  
Fig. 106



1144  
Fig. 2002



## Extracting Forceps "WITH Fitting Handle"



**1145**  
Fig. 1  
upper laterals  
and canines



**1146**  
Fig. 1  
upper laterals  
and canines



**1147**  
Fig. 3  
upper laterals  
and canines



**1148**  
Fig. 4  
lower incisors  
and canines



**1149**  
Fig. 7  
upper premolars

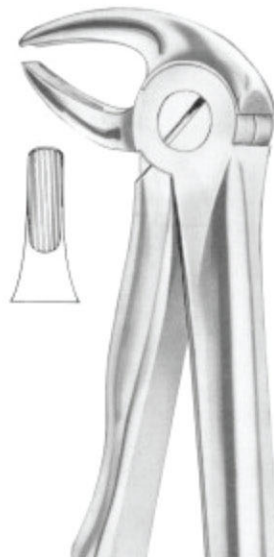

**1150**  
Fig. 13  
lower premolars



**1151**  
Fig. 13S  
lower premolars  
for children



## Extracting Forceps "WITH Fitting Handle"



**1152**  
Fig. 17  
upper molars right



**1153**  
Fig. 18  
upper molars left



**1154**  
Fig. 18A  
upper molars

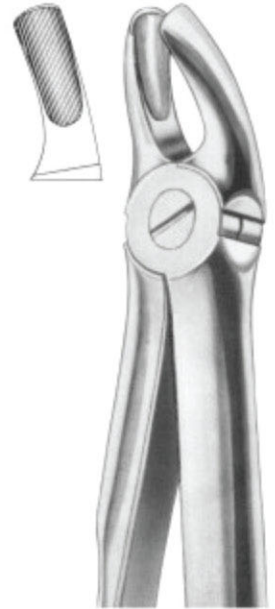

**1155**  
Fig. 18B  
upper molars



**1156**  
Fig. 19  
upper third molars



**1157**  
Fig. 22  
lower molars



**1158**  
Fig. 22S  
lower molars  
for children



## Extracting Forceps "WITH Fitting Handle"



**1159**  
Fig. 29  
upper roots



**1160**  
Fig. 29S  
upper roots  
for children

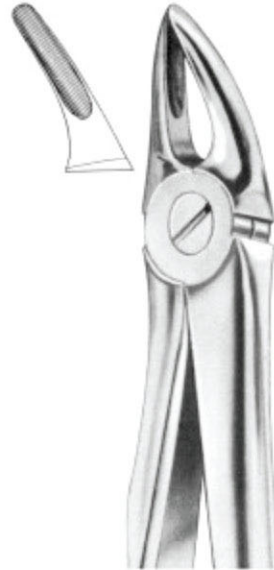

**1161**  
Fig. 30  
upper roots

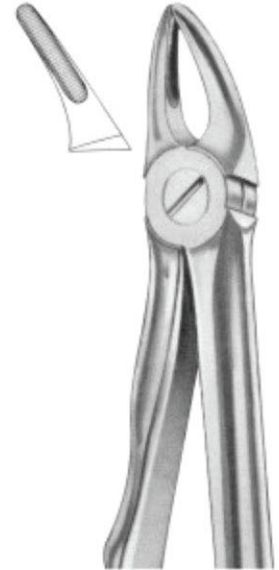

**1162**  
Fig. 30S  
upper roots  
for children

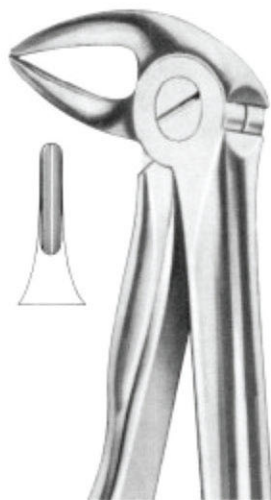

**1163**  
Fig. 33  
lower roots

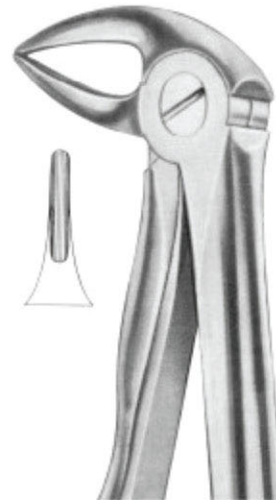

**1164**  
Fig. 33A  
lower roots

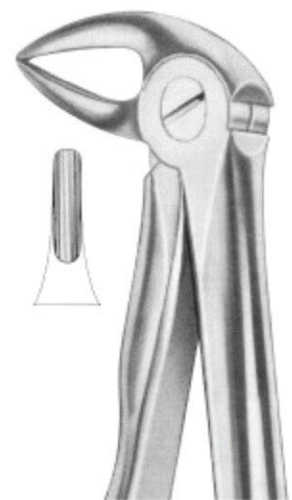

**1165**  
Fig. 33B  
lower roots





## Extracting Forceps "WITH Fitting Handle"



**1166**  
Fig. 33L  
lower roots



**1167**  
Fig. 33S  
lower roots  
for children



**1168**  
Fig. 37  
upper incisors  
for children



**1169**  
Fig. 39  
upper incisors  
for children



**1170**  
Fig. 33A  
upper roots  
for children



**1171**  
Fig. 39R  
upper molars right  
for children



**1172**  
Fig. 39L  
upper molars right  
for children



## Extracting Forceps "WITH Fitting Handle"



**1173**  
Fig. 41  
upper roots

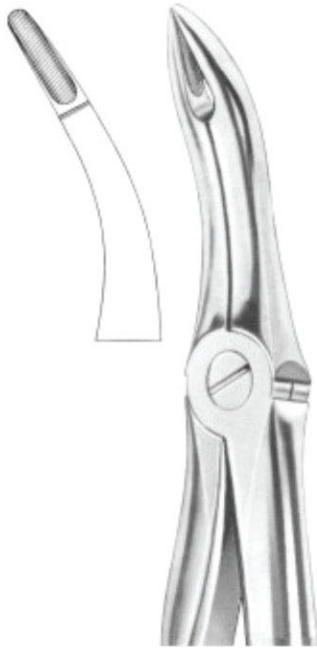

**1174**  
Fig. 44  
upper roots



**1175**  
Fig. 45  
lower roots



**1176**  
Fig. 48  
lower roots

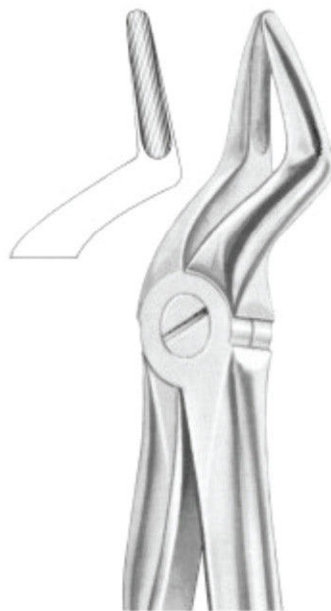

**1177**  
Fig. 51  
upper roots



**1178**  
Fig. 51A  
upper roots

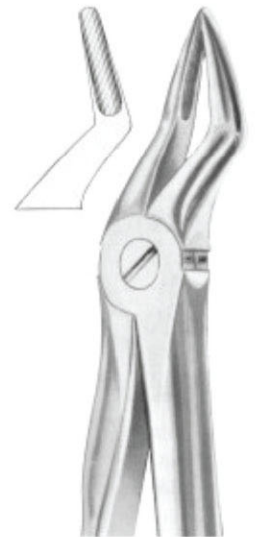

**1179**  
Fig. 51S  
upper roots  
for children



### Extracting Forceps "WITH Fitting Handle"



**1180**  
Fig. 51L  
upper roots

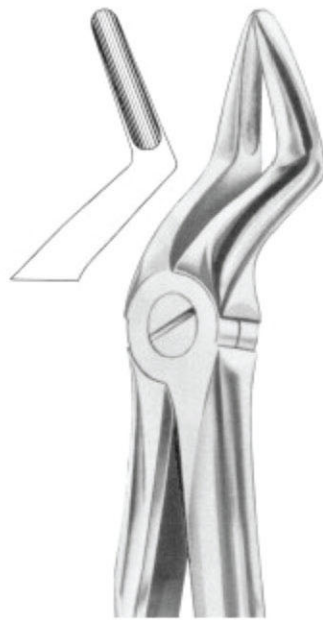

**1181**  
Fig. 52  
upper roots

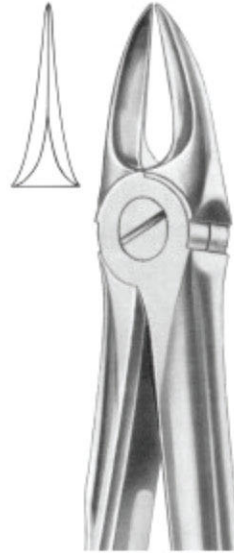

**1182**  
Fig. 54  
for separating  
upper molars



**1182**  
Fig. 65R  
upper molars right



**1184**  
Fig. 65L  
upper molars left



**1185**  
Fig. 67  
upper third molars

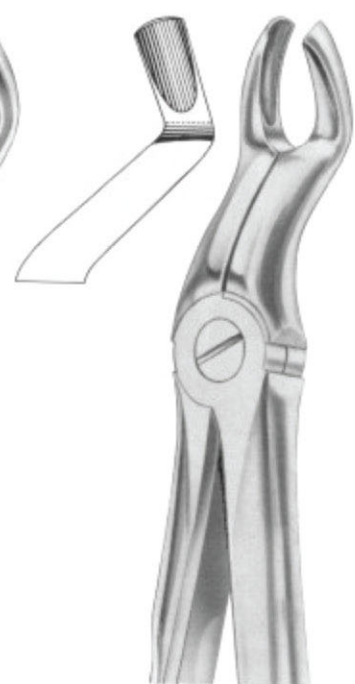

**1186**  
Fig. 67A  
upper third molars



### Extracting Forceps "WITH Fitting Handle"



**1187**  
Fig. 67 1/2 R  
upper third molars  
right

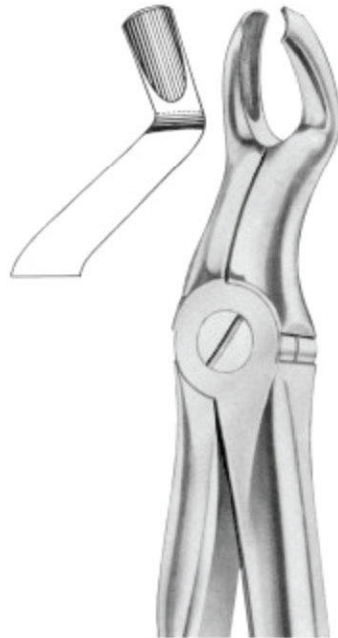

**1188**  
Fig. 67 1/2 L  
upper third molars  
right



**1189**  
Fig. 73  
lower molars



**1190**  
Fig. 74  
lower roots



**1191**  
Fig. 74M  
lower roots



**1192**  
Fig. 74N  
lower roots



**1193**  
Fig. 74XN  
lower roots and  
crowded incisors



## Extracting Forceps "WITH Fitting Handle"



**1194**  
Fig. 75  
lower premolars



**1195**  
Fig. 76  
upper molars



**1196**  
Fig. 76N  
upper molars



**1197**  
Fig. 81  
lower premolars  
and roots

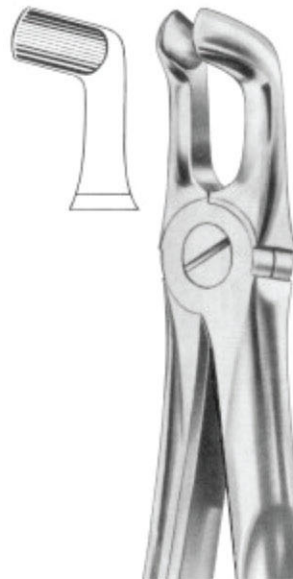

**1198**  
Fig. 76A  
lower third molars



**1199**  
Fig. 79  
lower third molars



## Extracting Forceps "WITH Fitting Handle"



**1200**  
Fig. 86A  
lower molars



**1201**  
Fig. 86B  
lower molars



**1202**  
Fig. 86C  
lower molars



**1203**  
Fig. 99  
lower molars



**1204**  
Fig. 99 1/4  
lower molars



**1205**  
Fig. 136  
upper premolars  
and roots



**1206**  
Fig. 143  
lower roots



Extracting Forceps “For Children”



**1207**  
KLEIN (Fig. 217)  
upper incisors



**1208**  
KLEIN (Fig. 218)  
upper premolars



**1209**  
KLEIN (Fig. 219)  
upper roots

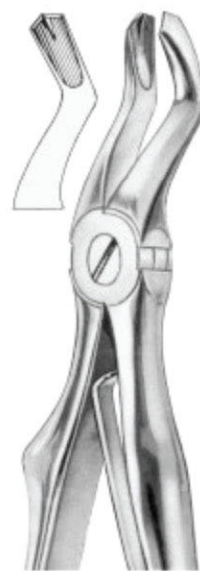

**1210**  
KLEIN (Fig. 220)  
upper molars



**1211**  
KLEIN (Fig. 221)  
lower incisors



**1212**  
KLEIN (Fig. 222)  
lower molars



**1212**  
KLEIN (Fig. 223)  
lower roots



**1214**  
ALBRECHT  
Fig. 224  
Deciduous



**1215**  
ALBRECHT  
Fig. 225  
Deciduous



# Root Splinter Forceps

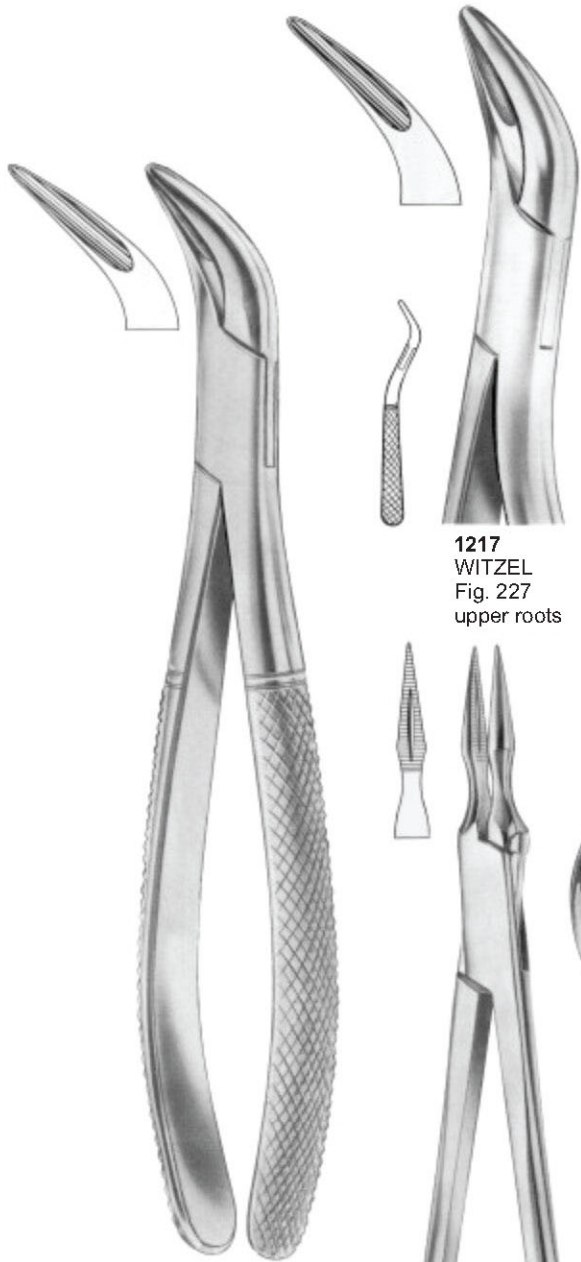

**1216**  
WITZEL  
Fig. 226  
lower roots

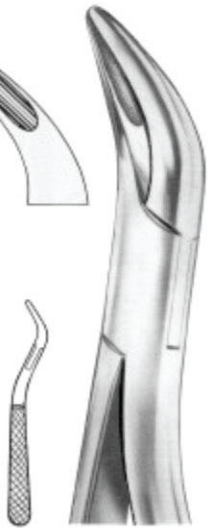

**1217**  
WITZEL  
Fig. 227  
upper roots



**1218**  
ARTHUR  
Fig. 229  
roots fragments



**1219**  
STIEGLITZ  
Fig. 229  
roots fragments



**1220**  
STIEGLITZ  
Fig. 230  
roots fragments



**1221**  
RALK  
Fig. 231  
roots fragments





## Extracting Forceps "American Pattern"



**1222**  
W1-WINTER  
upper centrals  
and canines



**1223**  
Fig.1  
upper incisors and roots

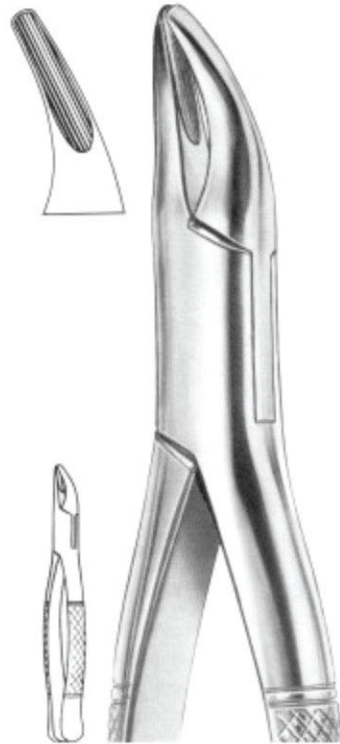

**1223**  
Fig.2  
upper and lower roots



**1223**  
Fig.4  
upper and lower premolars

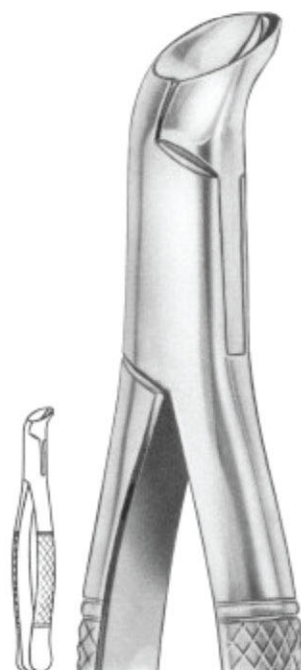

**1226**  
PHYSICK  
Fig.4  
lower third molars



**1227**  
Fig.6  
separating  
forceps



## Extracting Forceps "American Pattern"



**1228**  
Fig.7  
upper roots

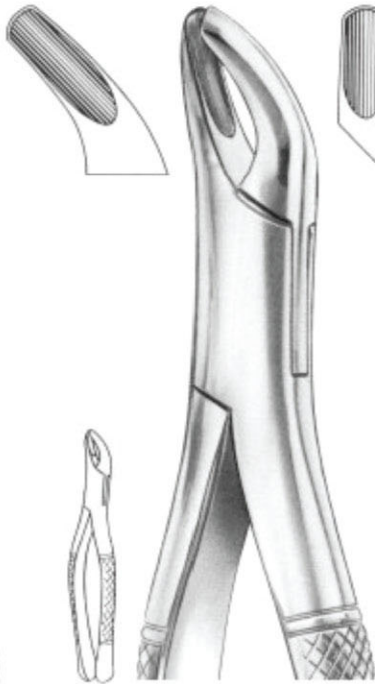

**1229**  
Fig.8  
upper and lower  
third molars



**1231**  
Fig.10H  
upper molars

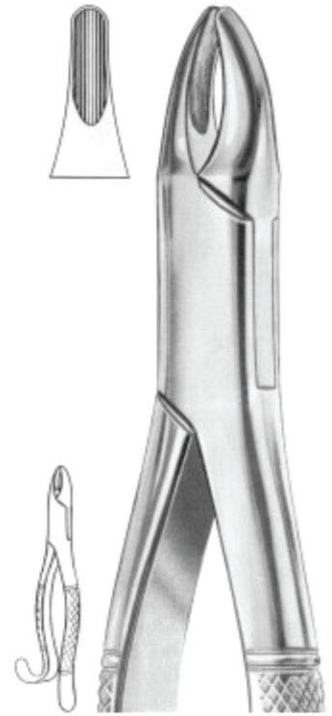

**1232**  
Fig.103  
upper incisors

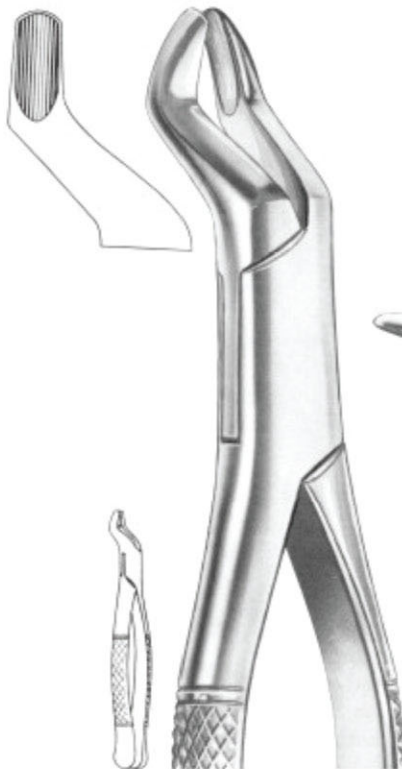

**1233**  
Fig.14  
lower incisors



## Extracting Forceps "American Pattern"



1234  
Fig.14  
lower molars



1234  
HARRIS  
Fig.15  
lower molars



1237  
HARRIS  
Fig.18R  
upper molars right



1238  
HARRIS  
Fig.18L  
lower molars left



1236  
Fig.16S  
lower molars  
for children

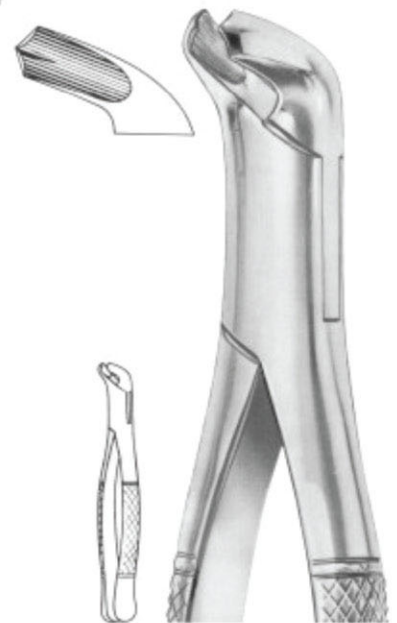

1239  
Fig.17  
lower molars



## Extracting Forceps "American Pattern"

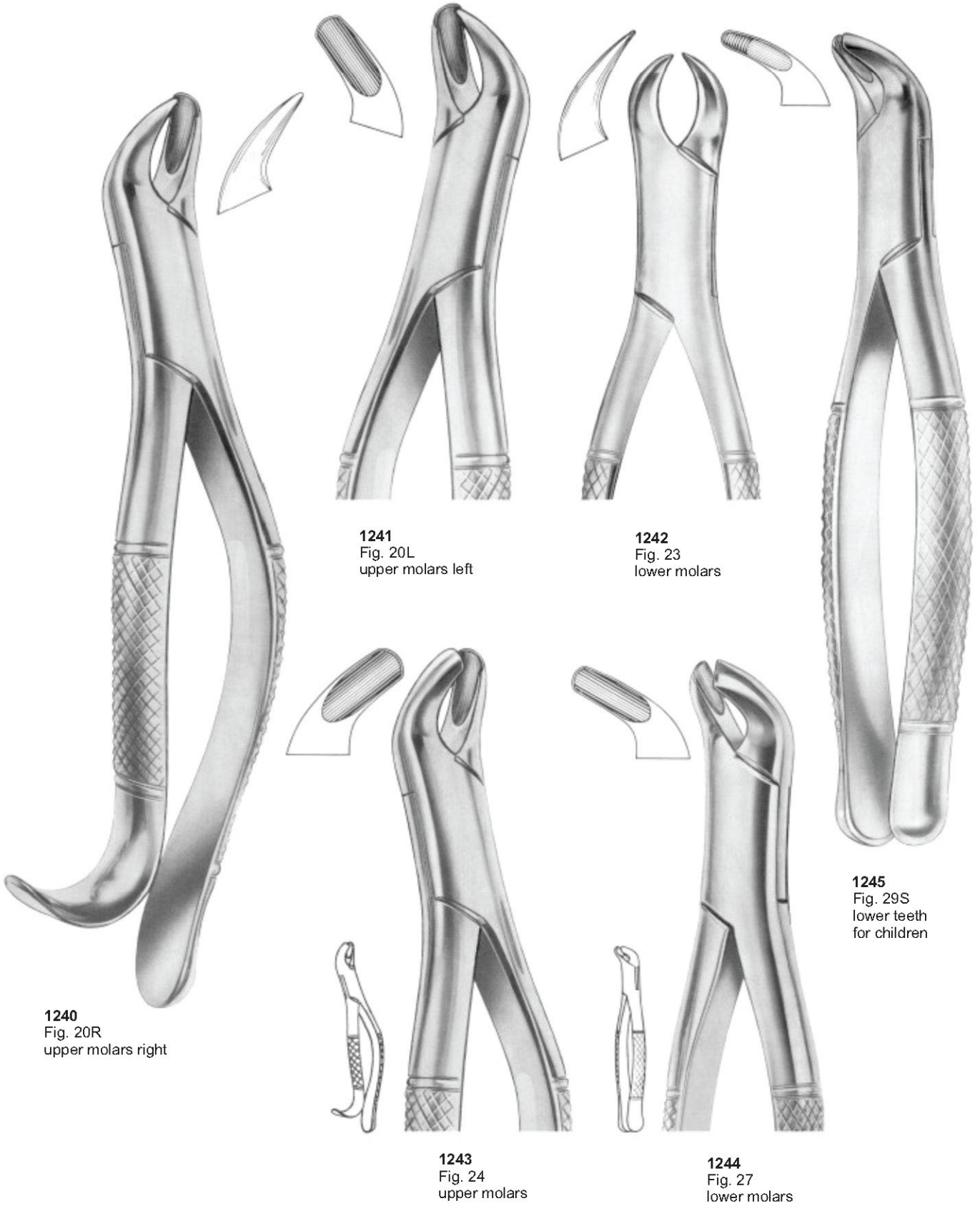

**1240**  
Fig. 20R  
upper molars right

**1241**  
Fig. 20L  
upper molars left

**1242**  
Fig. 23  
lower molars

**1245**  
Fig. 29S  
lower teeth  
for children

**1243**  
Fig. 24  
upper molars

**1244**  
Fig. 27  
lower molars



## Extracting Forceps "American Pattern"



**1246**  
Fig. 30S  
upper teeth  
for children



**1247**  
PARMLY  
Fig. 32  
upper premolars  
and molars



**1248**  
PARMLY  
Fig. 32A  
upper premolars  
and roots



**1248**  
Fig. 34  
lower anteriors  
and roots

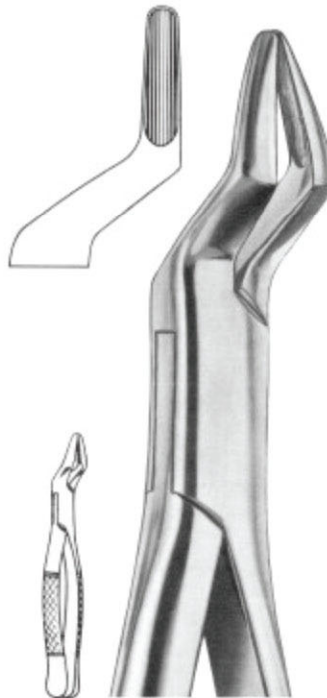

**1250**  
Fig. 35  
upper roots



**1251**  
Fig. 36  
lower anterior  
and roots



## Extracting Forceps “American Pattern”



**1252**  
Fig. 37  
lower anterior  
and roots

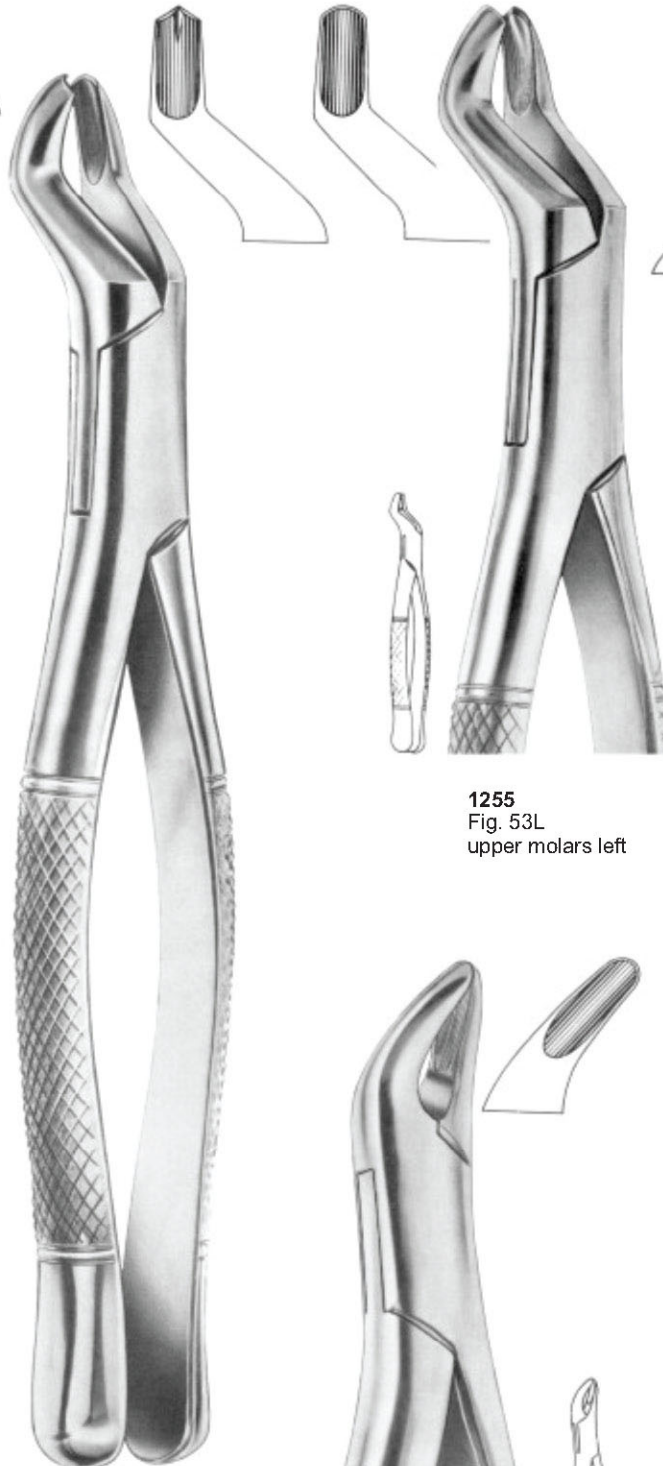

**1255**  
Fig. 53L  
upper molars left

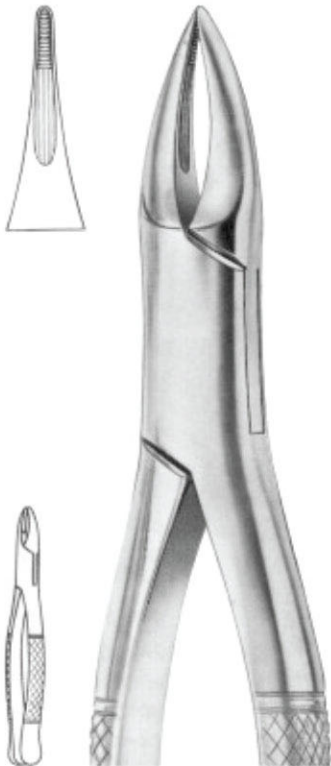

**1253**  
Fig. 38  
lower anterior  
and roots

**1254**  
Fig. 53R  
upper lower right

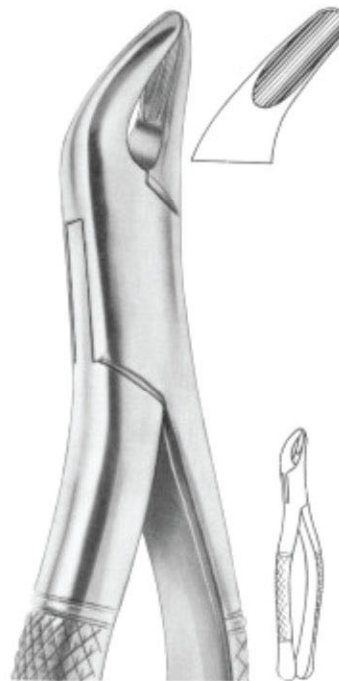

**1256**  
Fig. 62  
incisors, premolars,  
deciduous teeth



**1257**  
Fig. 66  
upper incisors  
and roots



## Extracting Forceps "American Pattern"



**1258**  
TOMES  
Fig. 69  
upper lower and roots



**1259**  
TOMES  
Fig. 85  
lower canines,  
premolars and molars

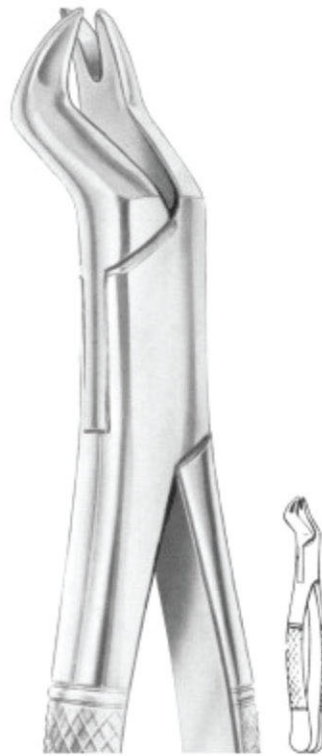

**1260**  
NEVIUS  
Fig. 88R  
upper molars right



**1261**  
TOMES  
Fig. 85A  
lower canines,  
premolars and molars



**1262**  
NEVIUS  
Fig. 88L  
upper molars left



Extracting Forceps “American Pattern”



**1268**  
CRYER  
Fig. 150  
lower incisors,  
premolars, roots



**1269**  
CRYER  
Fig. 150A  
lower incisors,  
premolars, roots

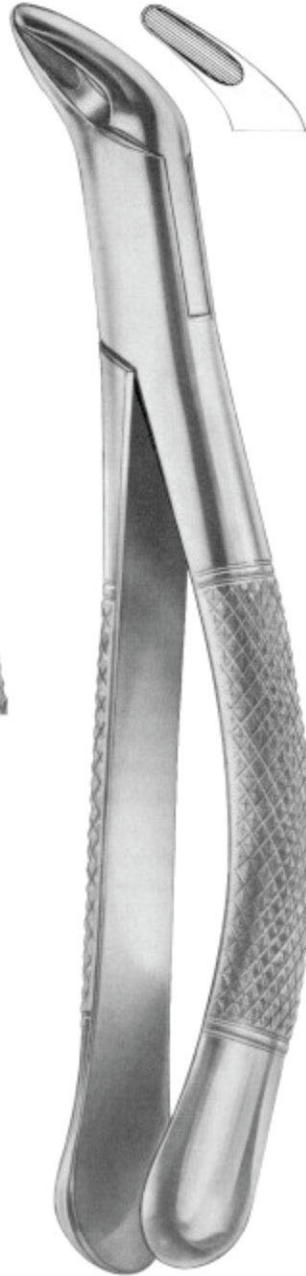

**1271**  
CRYER  
Fig. 151  
lower incisors,  
premolars, roots



**1272**  
CRYER  
Fig. 151A  
lower incisors,  
premolars, roots

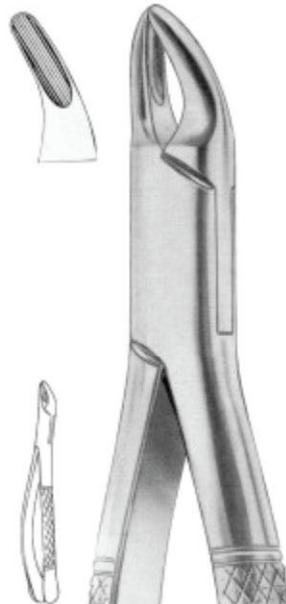

**1270**  
CRYER  
Fig. 150S  
upper teeth for children

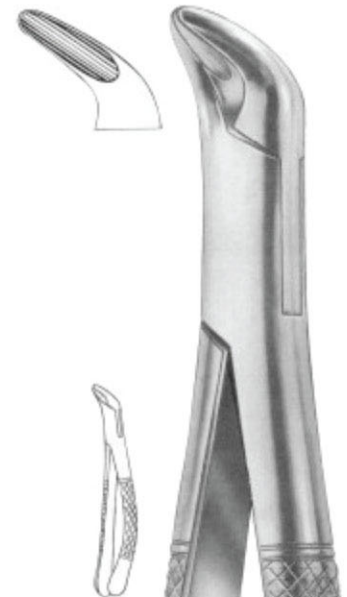

**1273**  
CRYER  
Fig. 151S  
lower teeth  
for children





# Extracting Forceps "American Pattern"



**1275**  
Fig. 210S  
upper third molars

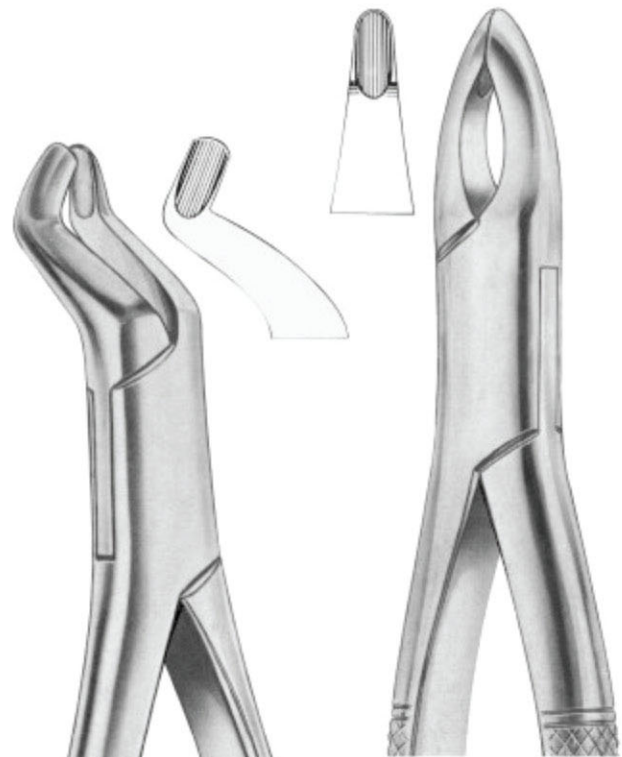

**1278**  
Fig. 213  
upper centrals and canines



**1274**  
Fig. 203  
lower incisors  
and roots



**1276**  
Fig. 201  
upper incisors,  
canines, premolars



**1277**  
Fig. 210H  
upper third molars

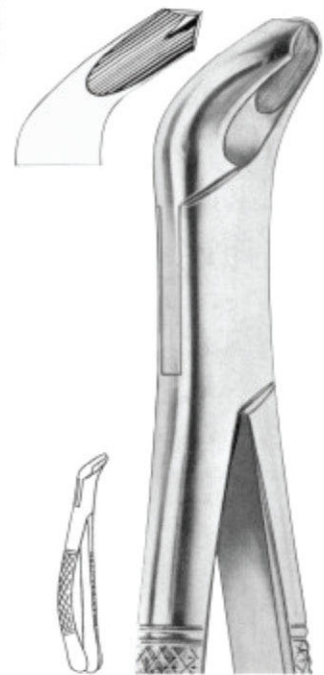

**1279**  
Fig. 217  
lower molars



## Extracting Forceps "American Pattern"

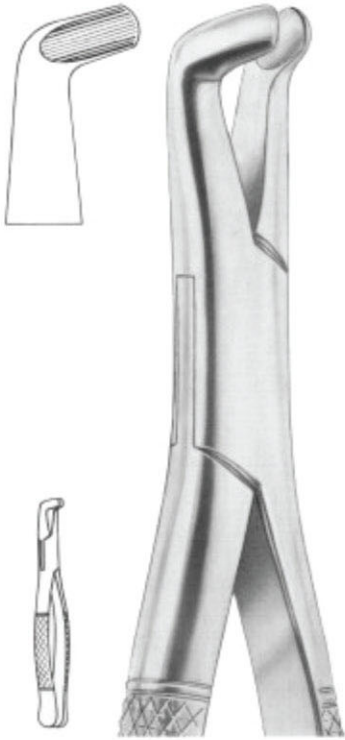

**1280**  
Fig. 222  
lower third molars



**1282**  
Fig. 286  
Swing lower molars



**1283**  
Fig. 288  
lower canines  
and premolars

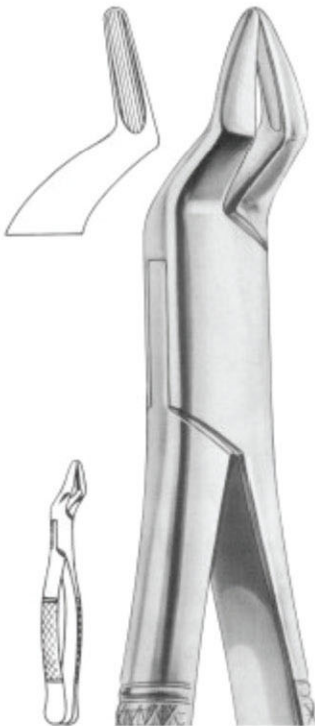

**1281**  
Fig. 286  
upper incisors and roots



# Extracting Forceps "American Pattern"

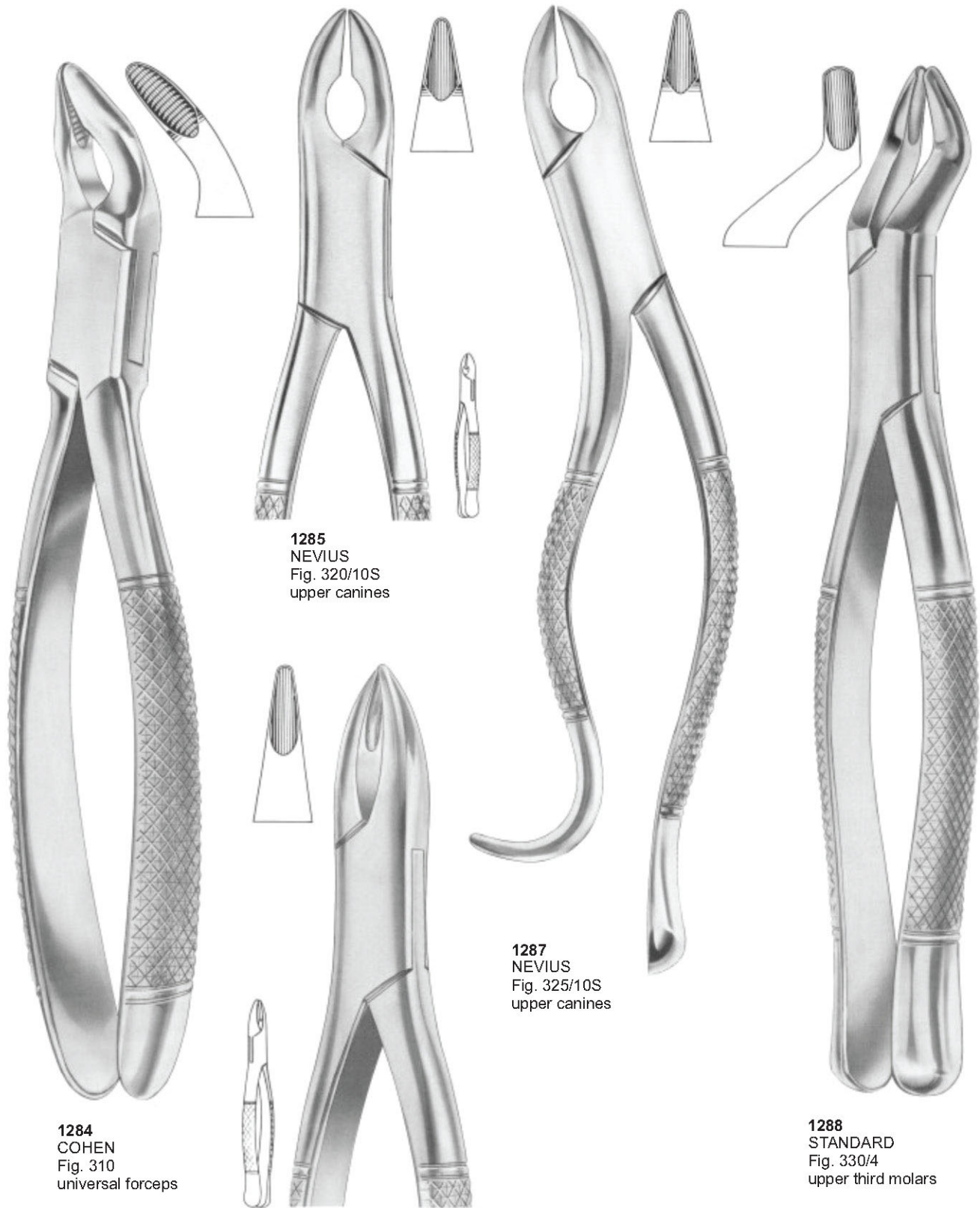

**1284**  
COHEN  
Fig. 310  
universal forceps

**1285**  
NEVIUS  
Fig. 320/10S  
upper canines

**1286**  
HENAHAN  
Fig. 315/1A upper canines

**1287**  
NEVIUS  
Fig. 325/10S  
upper canines

**1288**  
STANDARD  
Fig. 330/4  
upper third molars



## Extracting Forceps "American Pattern"



**1289**  
WOODEARD  
Fig. 335/FH  
lower molars

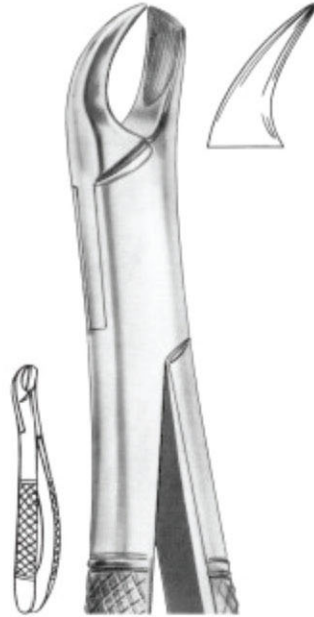

**1290**  
Fig. 340/89  
upper molars right



**1292**  
Fig. 345/90  
upper molars left

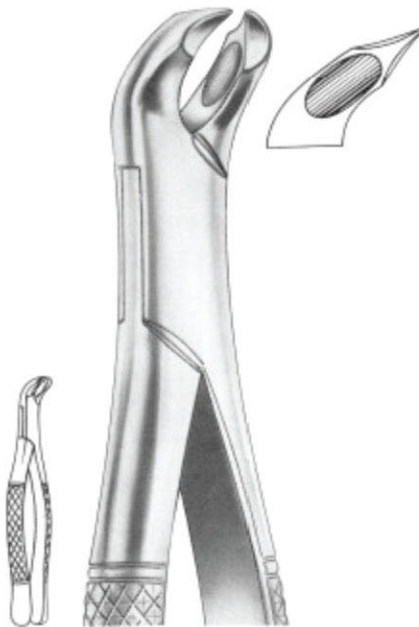

**1291**  
WOODEARD  
Fig. 335/FS  
lower molars



# Forceps For Children "American Pattern"



**1293**  
Fig. 350/23S  
lower molars

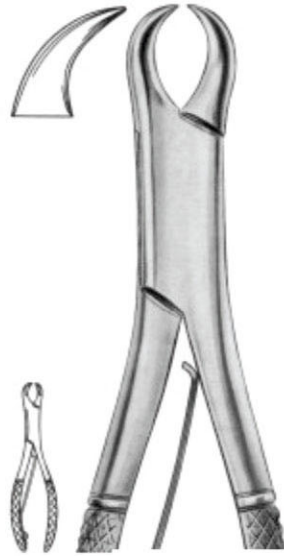

**1294**  
Fig. 355/23SK  
lower molars



**1295**  
Forceps Fig. 301



**1295-A**  
Forceps Fig. 300



**1296**  
Fig. 360/17SK  
lower molars



**1297**  
Fig. 365/150SK  
upper anteriors  
and roots



**1298**  
Fig. 370/151SK  
lower anteriors  
and roots



## Peristeel Elevators



**1299**  
Molt 9



**1300**  
Allen 9A



**1301**  
Pricheard



**1302**  
Seldin



**1303**  
Goldman-Fox 14



**1304**  
West  
Dell W2



# Elevators

## Heidbrink Root-Tip Picks

### Root Tip



1305  
DEL 78



1306  
DEL 79



1307  
DEL 80

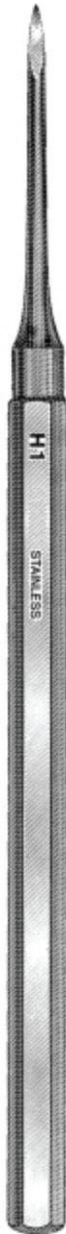

1308  
DEL H1



1309  
DEL H2



1310  
DEL H3



1311  
DEL H2-3



1312  
POTT  
6X

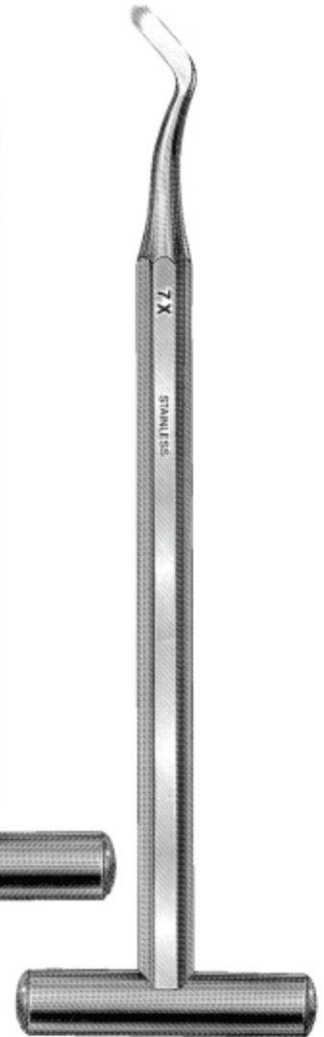

1313  
POTT  
6X



Peristeeel Elevators



1314  
BUSER



1315  
OH/10



1316  
HOWARD 9H



1317  
FREER



1318  
FREER 15



1316  
FREER 16





# Root Elevators

lower jaw, left side

lower jaw, left side



1320  
BEIN  
Fig.4



1331



1332

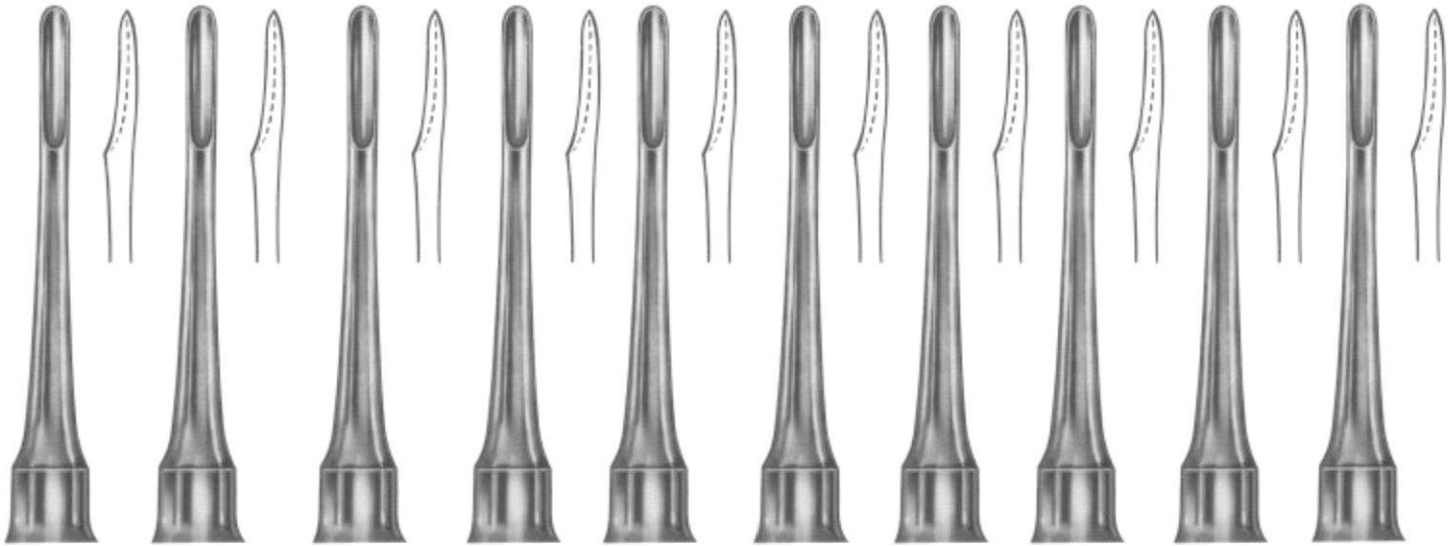

1321  
BEIN  
1.0 mm

1322  
BEIN  
1.5 mm

1323  
BEIN  
2.0 mm

1324  
BEIN  
2.5 mm

1325  
BEIN  
3.0 mm

1326  
BEIN  
3.5 mm

1327  
BEIN  
4.0 mm

1328  
BEIN  
4.5 mm

1329  
BEIN  
5.0 mm

1330  
BEIN  
5.5 mm



# Root Elevators



1333  
BEIN

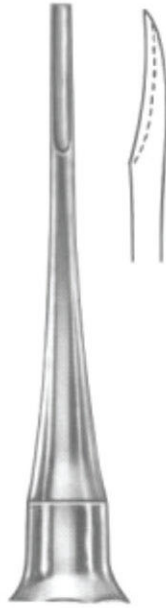

1334  
BEIN  
Fig. 1



1335  
BEIN  
Fig. 2



1336  
BEIN  
Fig. 0



1337  
BEIN  
Fig. 3



1338  
BEIN  
Fig. 4



1339  
BEIN  
Fig. 5



1340  
BEIN  
Fig. 6



# Root Elevators



**1341**  
CRYER  
Fig. 3



**1342**  
CRYER  
Fig. 4



**1343**  
CRYER  
Fig. 12



**1344**  
CRYER  
Fig. 27



**1345**  
CRYER  
Fig. 28



**1346**  
CRYER  
Fig. 27S



**1347**  
CRYER  
Fig. 28S



**1348**  
SELDIN  
Fig. 2



**1349**  
SELDIN  
Fig. 3



**1350**  
SELDIN  
Fig. 4L



**1351**  
SELDIN  
Fig. 4R



**1352**  
SELDIN  
Fig. 1L



**1353**  
SELDIN  
Fig. 1R



## Swa Elevators & Root Screws



1354



1355



1356



1357



1358



1359



1360



## Root Screws



1362  
Morrison  
2.0 mm



1363  
Morrison  
2.05 mm



1364  
Morrison  
23.0 mm



1361  
Morrison  
3.5 mm



Root Elevators



1365  
IS-APICAL



1366  
APICAL  
2 mm  
Fig. 1



1367  
APICAL  
3 mm  
Fig. 2



1368  
APICAL  
4 mm  
Fig. 3



1369  
APICAL  
4.5 mm  
Fig. 4



1370  
APICAL  
2 mm  
Fig. 5



1371  
APICAL  
3 mm  
Fig. 6



1372  
APICAL  
4 mm  
Fig. 7



1373  
APICAL  
4.5 mm  
Fig. 8



1374  
APICAL  
Fig. 9



1375  
WINTER  
Fig. 14 L



1376  
WINTER  
Fig. 14 R



1377  
HEIDBRINK  
Fig. 1



1378  
HEIDBRINK  
Fig. 2



1379  
FIOHR  
Fig. 1



1380  
FIOHR  
Fig. 2



1381  
Apical  
Fig. 1



1382  
Apical  
Fig. 2



# Root Elevators



**1383**  
IS-CRYER



**1384**  
CRYER  
Fig. 1



**1384**  
CRYER  
Fig. 2



**1386**  
IS-COUPLAND



**1387**  
COUPLAND  
Fig.1



**1388**  
COUPLAND  
Fig.2



**1389**  
COUPLAND  
Fig.3



# Root Elevators



1390  
Fig. 1



1391  
Fig. 2



1392  
Fig. 3



1393  
FLOHR  
Fig. 1



1394  
FLOHR  
Fig. 2



1395  
FLOHR  
Fig. 3



# Root Elevators



1396  
KOPP  
Fig. 1



1397  
KOPP  
Fig. 2



1403  
KOPP  
Fig. 1



1404  
KOPP  
Fig. 2



1396  
KOPP



1398  
KOPP  
Fig. 3



1399  
KOPP  
Fig. 4



1402  
KOPP



1405  
KOPP  
Fig. 3



1406  
KOPP  
Fig. 4



1400  
KOPP  
Fig. 3



1401  
KOPP  
Fig. 6





# Root Elevators



1407  
HYLIN



1407  
HYLIN  
Fig. 1



1408  
HYLIN  
Fig. 2



1409  
BEIN

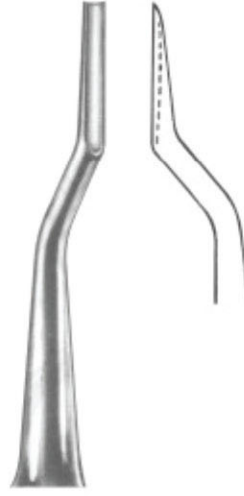

1409  
BEIN  
Fig.1

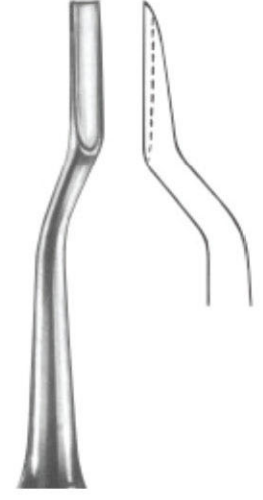

1410  
BEIN  
Fig.2



1411  
BEIN  
Fig. 3

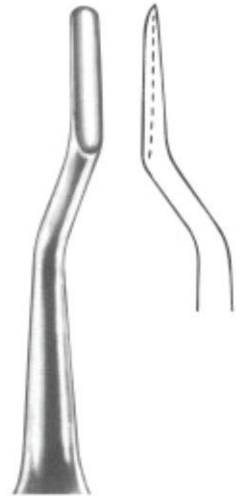

1412  
BEIN  
Fig.4



# Root Elevators



**1413**  
WARWICK-JAMES  
Fig.1



**1413**  
WARWICK-JAMES  
Fig.2



**1414**  
WARWICK-JAMES  
Fig.3



**1415**  
LONDON-HOSPITAL  
Fig.1



**1415**  
LONDON-HOSPITAL  
Fig.2



**1416**  
LONDON-HOSPITAL  
Fig.3

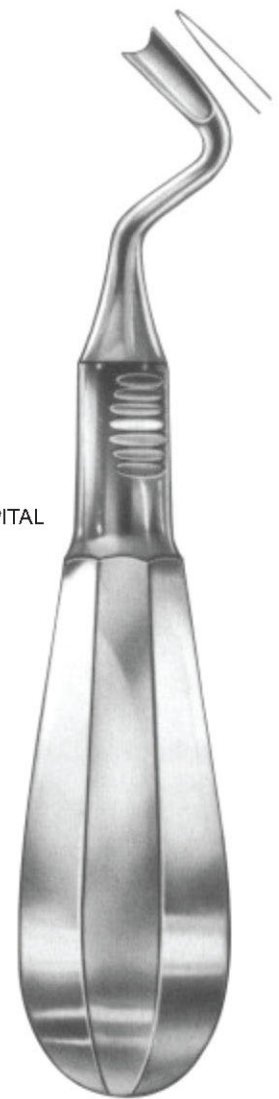

**1417**  
OTT



# Root Elevators



1418  
CHOMPRET  
Fig.1



1419  
CHOMPRET  
Fig.2



1420  
CHOMPRET  
Fig.3



1421  
CHOMPRET  
Fig.4



1423  
Fig.1



1422  
Fig. 2

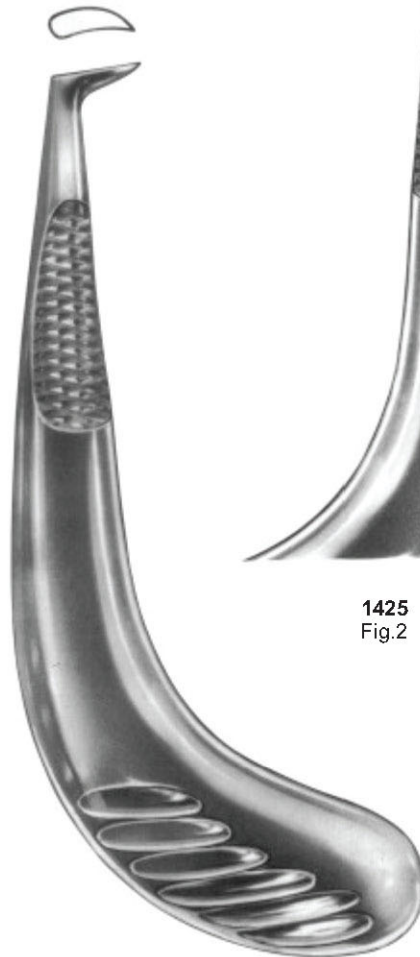

1424  
Fig.1



1425  
Fig.2



1426  
APICAL



# Root Elevators



1427  
IS-Fig. 1



1428  
Fig. 2



1429  
Fig. 3



1430  
HEIDBRINK  
Fig. 1



1431  
HEIDBRINK  
Fig. 2



1432  
HEIDBRINK  
Fig. 3



1438  
MEAD  
MD-1



1433  
LECLUSE



1434  
MEAD  
MD-5A



1435  
MEAD  
MD-6A



1436  
MEAD  
MD-7A



1437  
MEAD  
MD-8



# Root Elevators



**1439**  
WINTER  
Fig. 1L



**1440**  
WINTER  
Fig. 1R



**1441**  
WINTER  
Fig. 2L



**1442**  
WINTER  
Fig. 2R

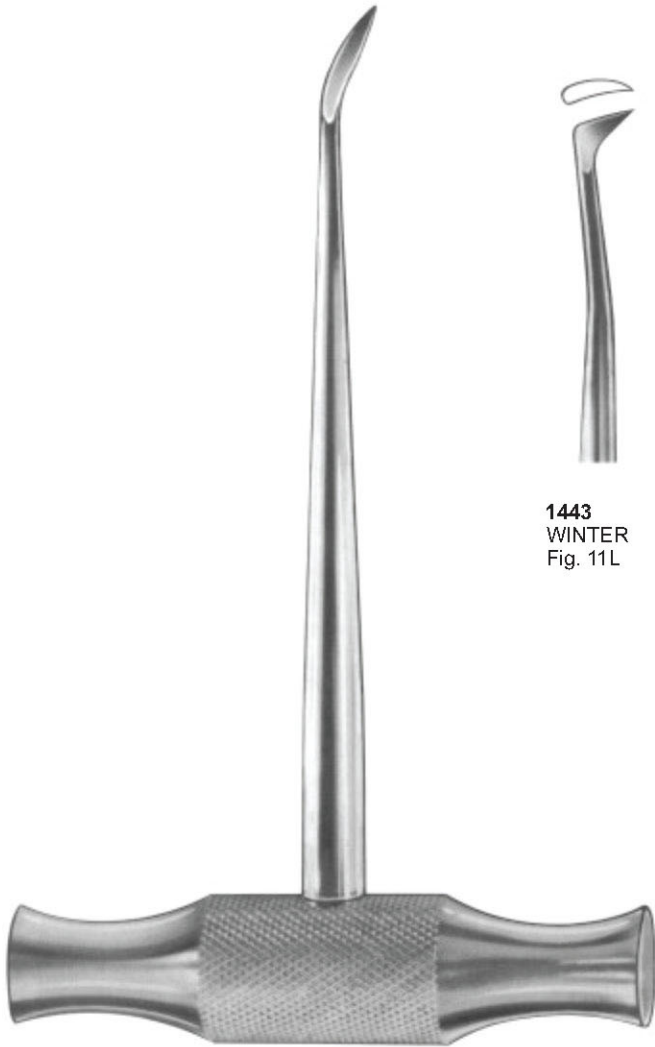

**1439**  
WINTER



**1443**  
WINTER  
Fig. 11L



**1444**  
WINTER  
Fig. 11R



**1445**  
WINTER  
Fig. 12L



**1446**  
WINTER  
Fig. 12R



**1447**  
WINTER  
Fig. 14L



**1448**  
WINTER  
Fig. 14R



# Root Elevators



1449  
BARRY  
Fig. 1



1450  
BARRY  
Fig. 2



1451  
BARRY  
Fig. 3



1452  
BARRY  
Fig. 4



1449  
BARRY



1453  
BARRY  
Fig. 11



1454  
BARRY  
Fig. 12



1455  
BARRY  
Fig. 17



1456  
BARRY  
Fig. 18



## Root Elevators



**1458**  
CAYER  
Fig. 26



**1459**  
SELDIN  
Fig. 27



**1460**  
CAYER  
Fig. 28



**1461**  
CAYER  
Fig. 29



**1462**  
HEIDBRINK  
Fig. 22



**1463**  
HEIDBRINK  
Fig. 23



**1457**



# Root Elevators



1465  
KOPP  
Fig. 31



1466  
KOPP  
Fig. 32



1467  
KOPP  
Fig. 33



1468  
KOPP  
Fig. 34



1469  
KOPP  
Fig. 35



1470  
KOPP  
Fig. 44



1464





# Root Elevators



1472  
HEIDBRINK  
Fig. 10



1473  
WINTER  
Fig. 11



1474  
WINTER  
Fig. 12



1475  
BARRY  
Fig. 17



1476  
BARRY  
Fig. 18



1477  
BARRY  
Fig. 20

## Root Elevators according to Dr. Sader with interchangeable working tip

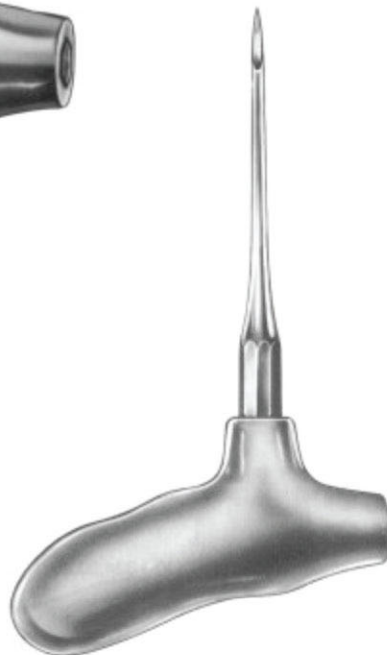

1478



1479



1480



### Elevators Plastic Handle

1481  
Root Elevator, Plastic Handle, Set of 10 Pcs

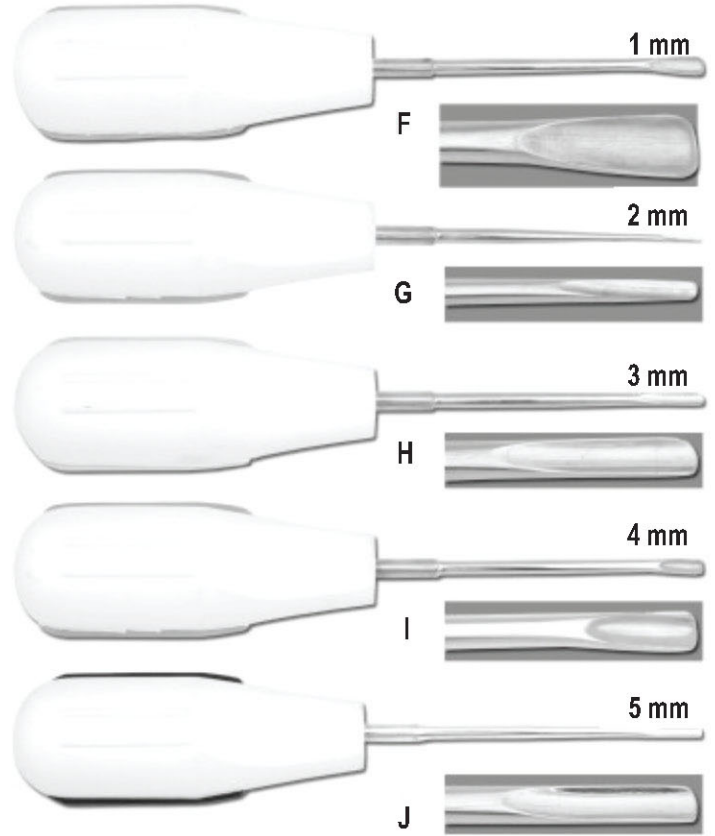
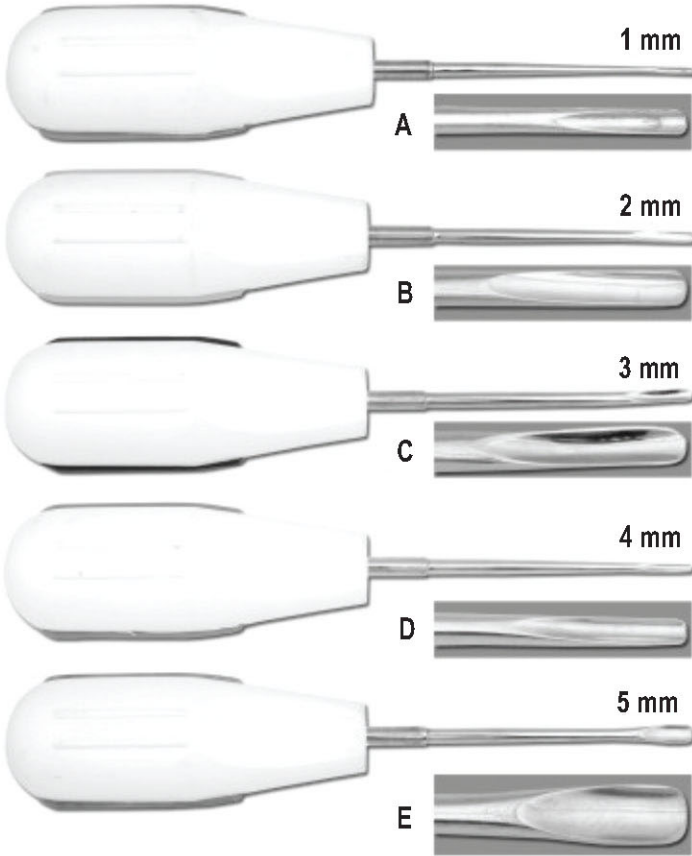

1482  
Root Elevators, Plastic Handle, Set of 5 Pcs

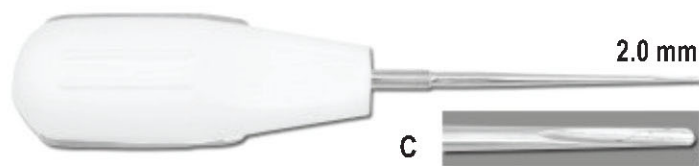
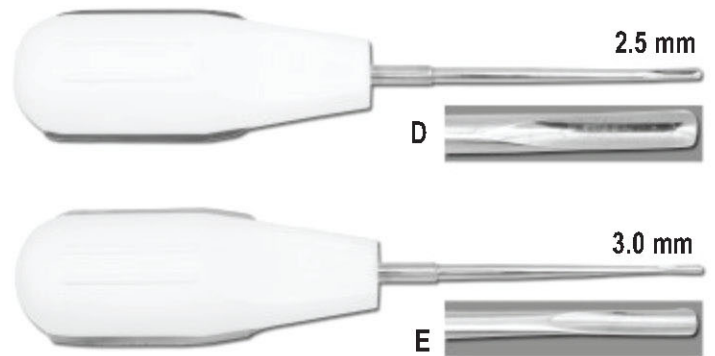
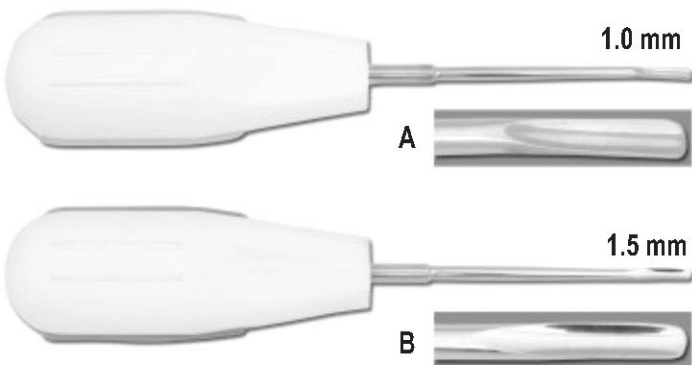



## Scalpel Handle



**1484**

Scalpel Handle Angle Of Blade Adjusts To Easily Get Around Corners  
Adjustment Sets Blade From Straight To Back Angled  
Locks In At 90, 60, 30, Straight, -30, -60 Angles



**1484**  
Scalpel Handle  
Fig. 5



**1485**  
Scalpel Handle  
Curved



**1486**  
Fig. 3L



**147**  
Fig. 7



**1488**  
Scalpel Handle  
Fig. 4L, Curved  
20 cm



**1489**  
Fig. 3



**1490**  
Fig. 3G



**1491**  
Fig. 4



**1492**



**1493**  
Scalpel Handle  
4 D 14.0 cm



**1494**  
Mess Holders



**1495**  
Gouge  
Blade Handle  
Fig. 2 / 11.5 cm



## Handle

Handle For Mouth Mirrors, Probes, Explorers, Excavators, Carvers, Curetter & Scalers



**1496**  
Handle No. 2 Standard Single Ended



**1497**  
Handle Single Ended



**1498**  
Handle Single Ended

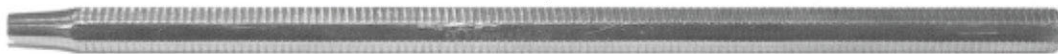

**1499**  
Handle Single Ended



**1500**  
Octagonal Double Ended



**1501**  
Octagonal Double Ended



**1502**  
Octagonal Double Ended



**1503**  
Handle No. 2 (Standard Double Ended)



**1504**  
Octagonal Double Ended



**1505**  
Tactile tone Double Ended



**1506**  
Tactile tone Double Ended



**1507**  
Tactile tone Double Ended



**1508**  
Handle Double Ended



**1509**  
Double Ended

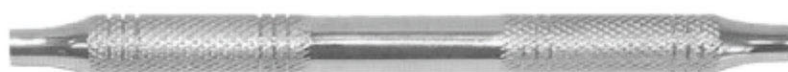

**1510**  
Tactile tone Double Ended



**1511**  
Tactile tone Double Ended



## Handle & Mouth Mirrors

### Mouth Mirrors Plane

### Mouth Mirrors, Magnifying 1513-A

Plain 1512-b

Fig.00	∅	8 mm
Fig.0	∅	10 mm
Fig.1	∅	14 mm
Fig.2	∅	16 mm
Fig.3	∅	18 mm
Fig.4	∅	20 mm
Fig.5	∅	22 mm
Fig.6	∅	24 mm
	∅	26 mm
Fig.8	∅	28 mm
Fig.9	∅	30 mm
Fig.10	∅	32 mm

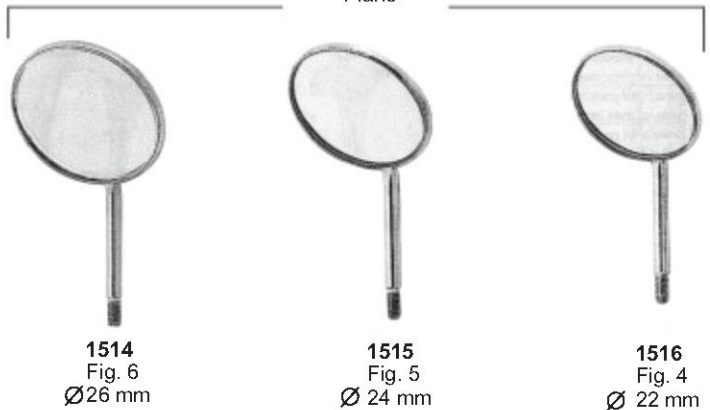

1514  
Fig. 6  
∅26 mm

1515  
Fig. 5  
∅ 24 mm

1516  
Fig. 4  
∅ 22 mm

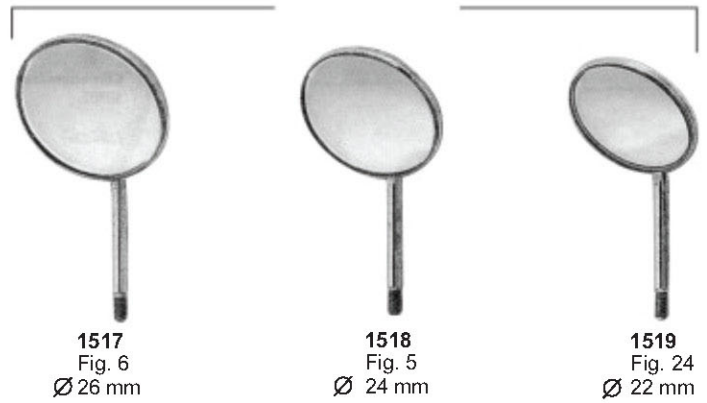

1517  
Fig. 6  
∅26 mm

1518  
Fig. 5  
∅ 24 mm

1519  
Fig. 24  
∅ 22 mm

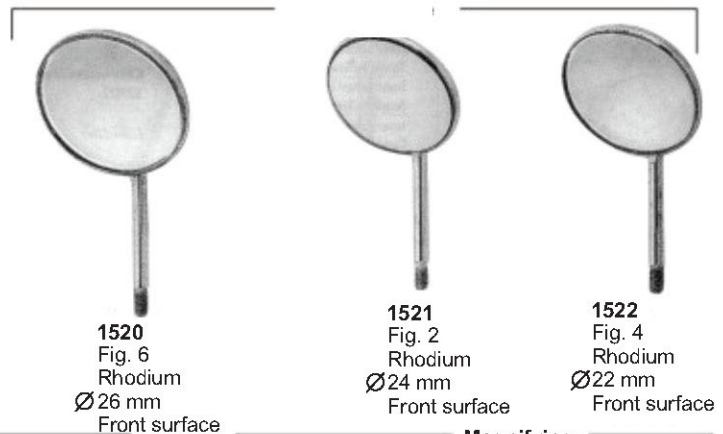

1520  
Fig. 6  
Rhodium  
∅26 mm  
Front surface

1521  
Fig. 2  
Rhodium  
∅24 mm  
Front surface

1522  
Fig. 4  
Rhodium  
∅22 mm  
Front surface

### Plane

### Magnifying

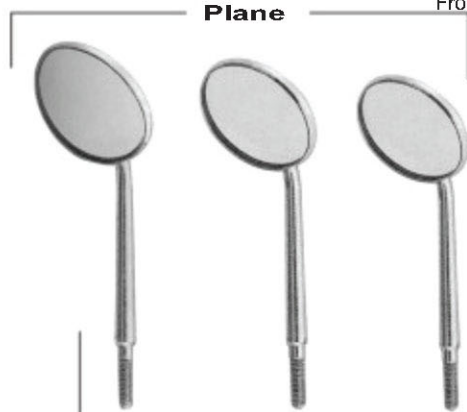

1523  
Fig. 6  
∅26 mm

1524  
Fig. 5  
∅24 mm

1525  
Fig. 4  
∅22 mm



1526  
Fig. 6  
∅ 26 mm

1527  
Fig. 5  
∅ 24 mm

1528  
Fig. 4  
∅22 mm



1512  
Hollow Handle  
Fig. 1



1513  
Hollow Handle  
Fig. 2

1513-A



### Mirror Handle, Mouth Mirrors

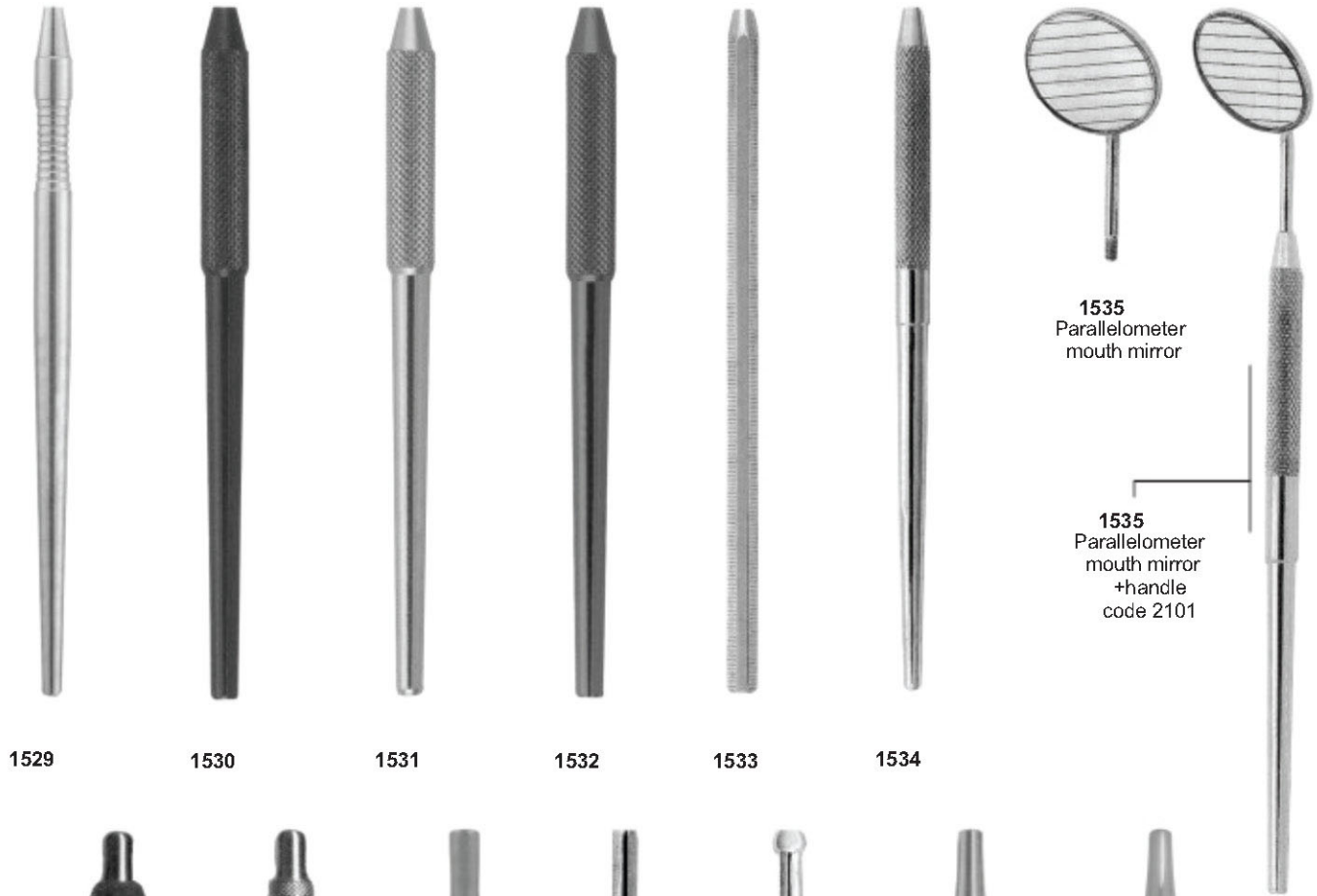

1529 1530 1531 1532 1533 1534

1535  
Parallelometer  
mouth mirror

1535  
Parallelometer  
mouth mirror  
+handle  
code 2101



1537  
Tactilr Tone  
Single Ended

1538  
Handle  
Thompson  
Single Ended

1539  
Hollow Handle

1540  
Hollow Handle  
Stainless  
Steel

1541  
Cone-socket  
Hollow Handle

1542  
Hollow Handle

1543  
Hollow Handle



Scalers

SCALER- JAQUETTE

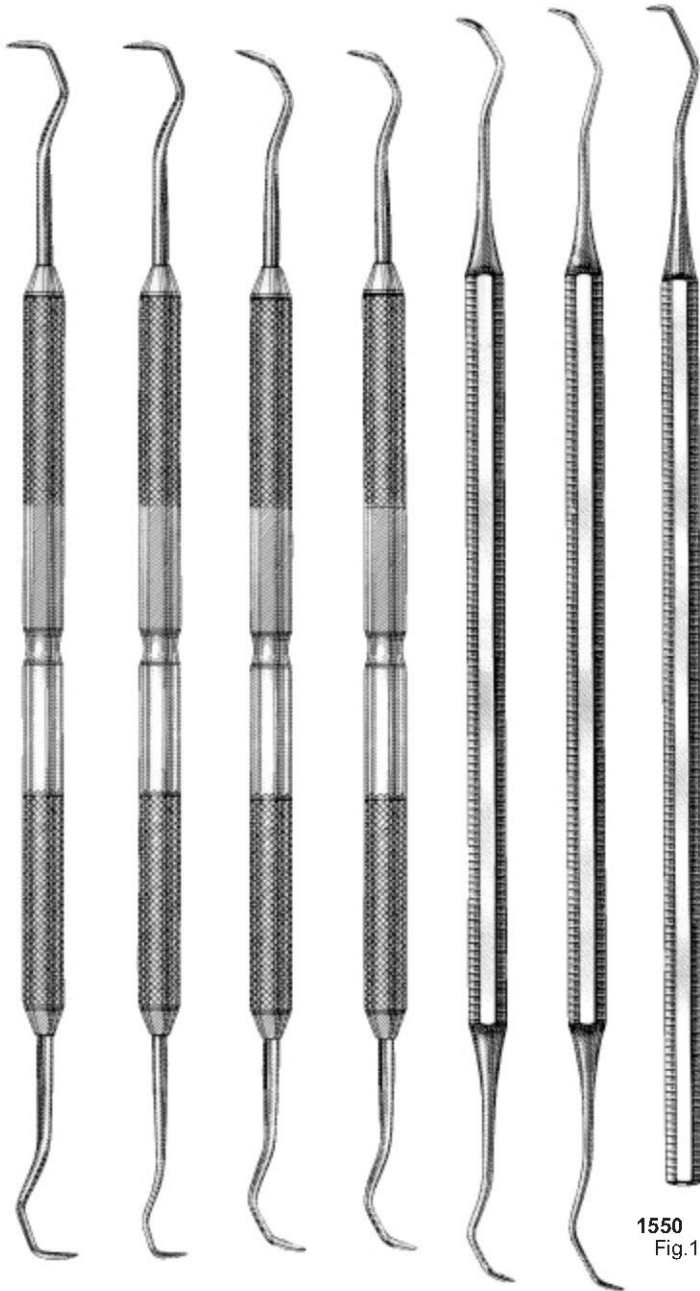

1550  
Fig.1

- 1544  
1Y-1Y
- 1545  
1Y-1YS
- 1546  
2Y-3Y
- 1547  
2YS-3YS
- 1548  
2-3
- 1549  
2S-3S

SCALER- OCTAGONAL

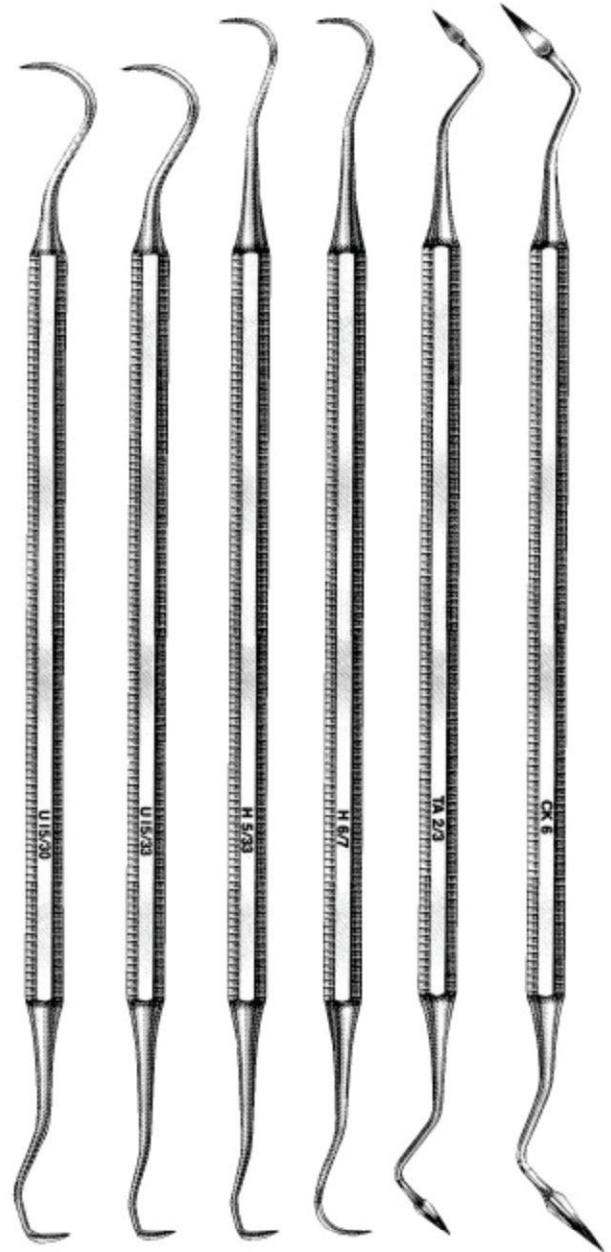

- 1551  
U15-30
- 1552  
U15-33
- 1553  
H5-33
- 1554  
H6-7
- 1555  
Taylor 2-3
- 1556  
Ck6



Scalers



1557  
U15



1558  
No.3



1559  
No.12



1560  
WHITESIDE 1-0

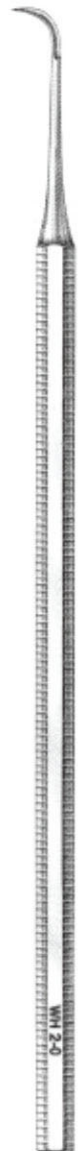

1561  
WHITESIDE 2-0





Scalers



1562  
YAOUNGER/GOOD  
7-8



1563  
H5-33



1564  
204SD



1565  
H6-7



1566  
204S



1567  
TOWNER/JAQUWTE  
U15-3C



# Scalers



**1568**  
JAQUETTE (33-U150)



**1569**  
JAQUETTE  
2Y-3Y



**1570**  
JAQUETTE  
30-U15



**1571**  
JAQUETTE  
2YS-3YS



**1572**  
JAQUETTE  
33-H5



**1573**  
YOUNGER/GOOD  
7-8



**1574**  
204S



**1575**  
204SD



**1576**  
H6-7

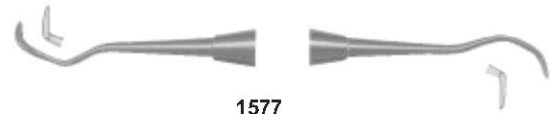

**1577**  
JAQUETTE  
2S-3S



**1578**  
JAQUETTE  
1Y-1YS

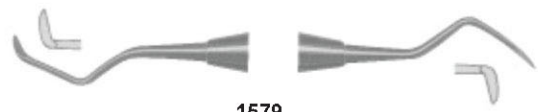

**1579**  
JAQUETTE  
2-3



Scalers



1580  
JAQUETTE (33-U15)



1581  
S204



1582  
Jack-Nebraska



1583  
S204S



1584  
Jaquette 1-U15



1585  
S204SD



1586  
Jaquette 2-3



1587  
Goldman Fox 21



1588  
Jaquette 2S-3S



1589  
Goldman Fox 21



1590  
Jaquette 30-u15



1591  
H5-U15



1592  
Jaquette 30-33



1593  
Jaquette 34-35



1594  
Jaquette 31-32

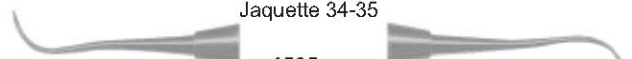

1595  
Thompson Jr.



1596  
Jaquette 33-h5

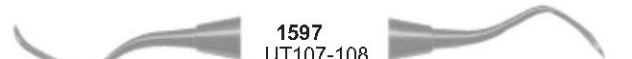

1597  
UT107-108



1598  
U 6-7



1599  
Up128



1600  
128L



# Explorers

## Explorers Double Ended-Octagonal

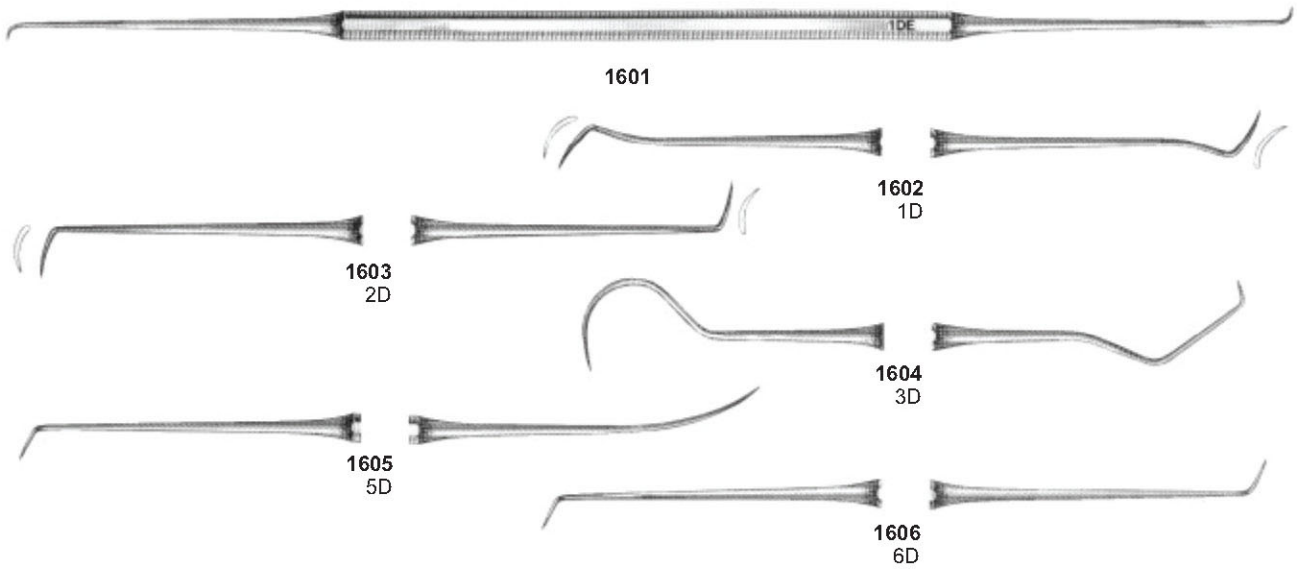

## Explorers Double Ended-Standard

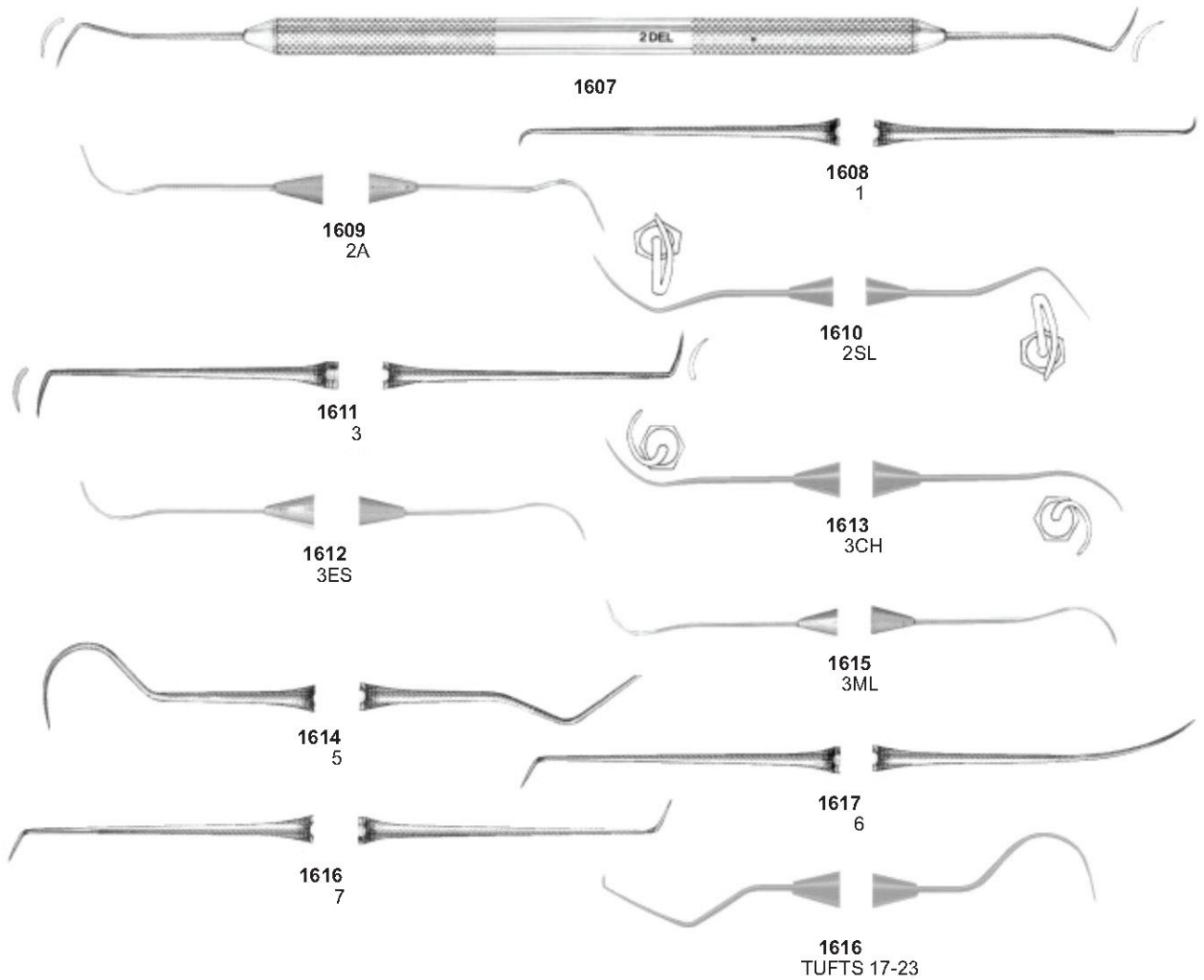



Explores

Explorers Double Ended Tactile Tone



1619  
2A



1620  
2



1621  
1



1622  
2SL



1623  
3



1624  
3CH



1625  
3ES



1626  
3ML



1627  
5



1628  
6



1629  
7

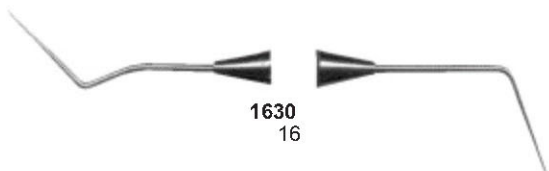

1630  
16



1631  
TUFTS 17/23



## Explorers & Probes

### Explorers Single Ended-Octagonal



### Explorers Single Ended-Standard



### Probe / Explorers-Octagonal



### Double Ended Probe-Octagonal





Probes

**Probes Double Ended-Standard**

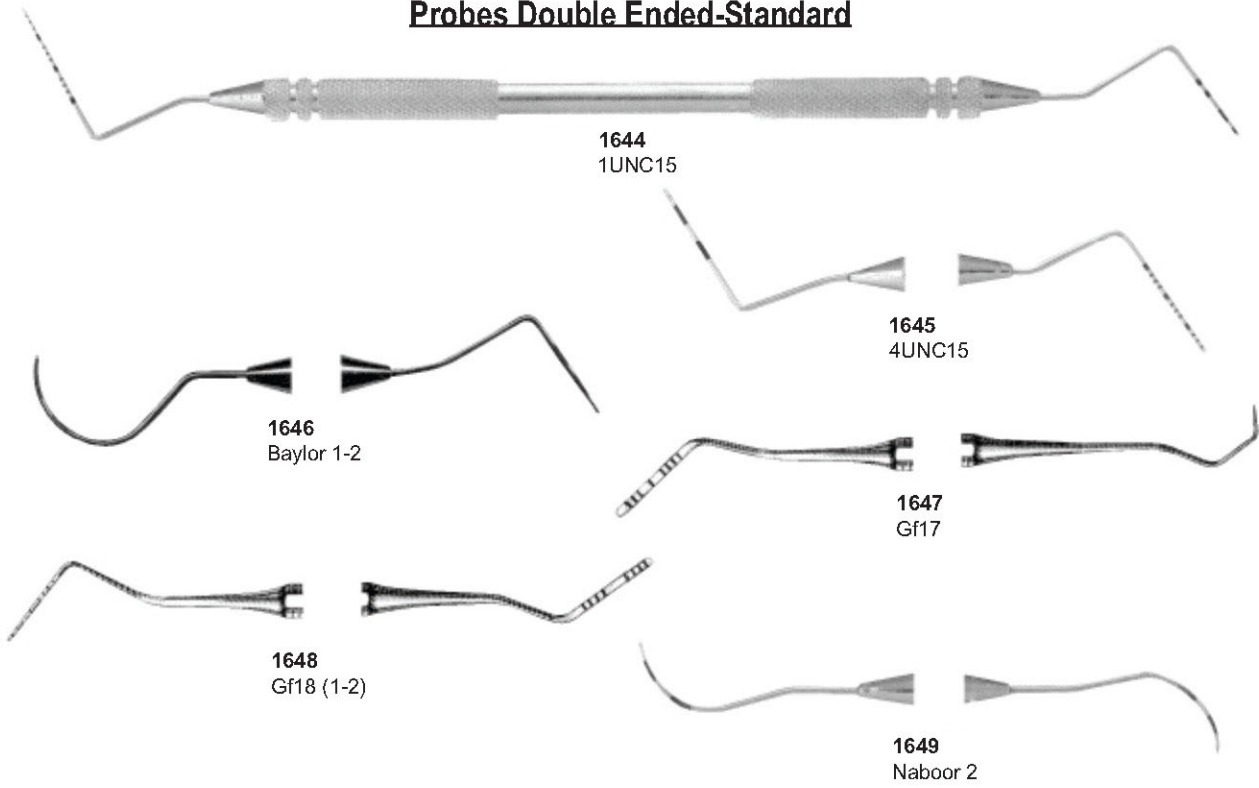

**Probes Double Ended-Tactile Tone**

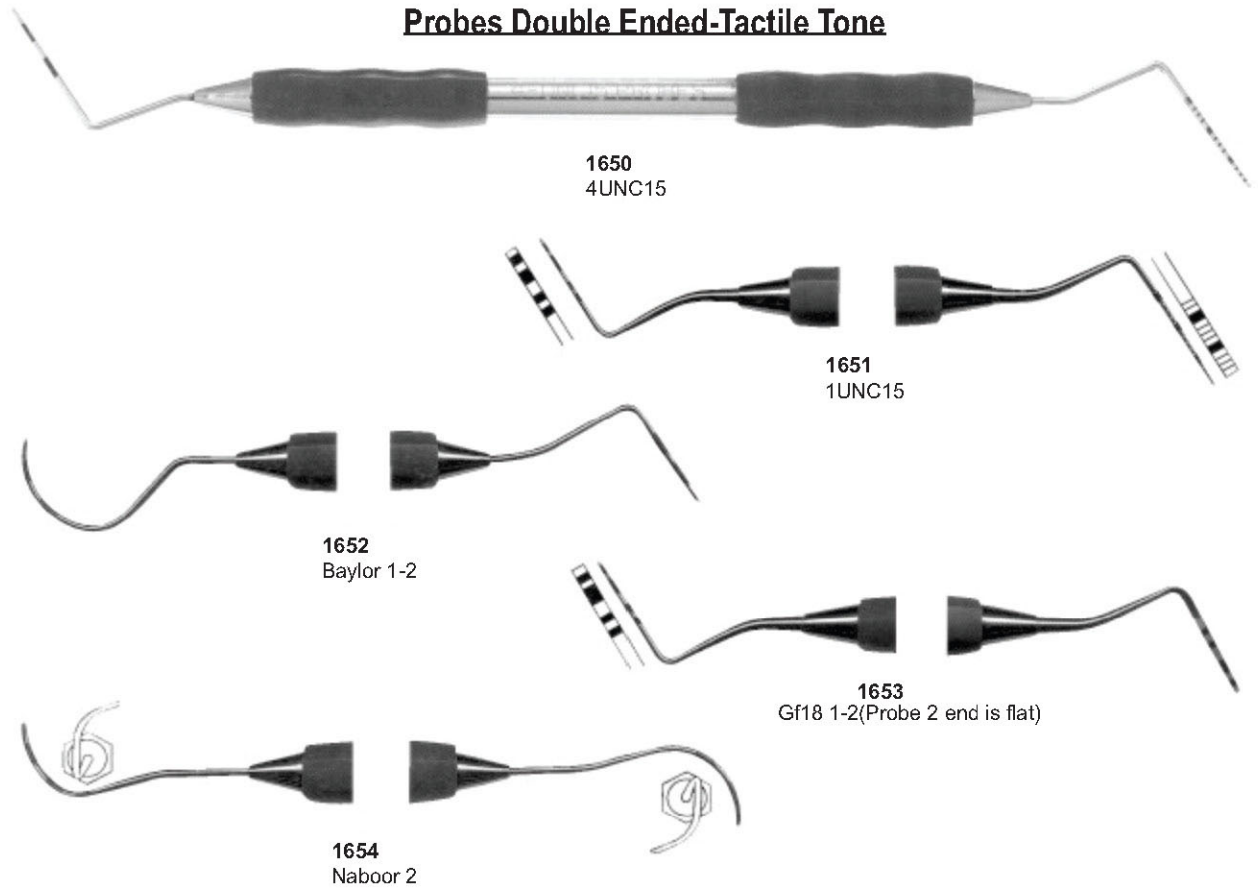



Probe

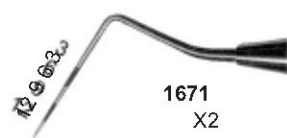
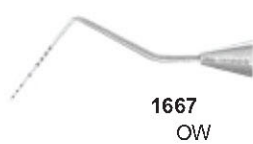
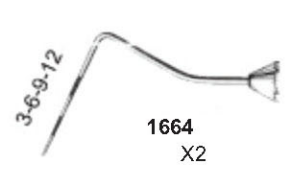
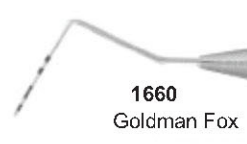
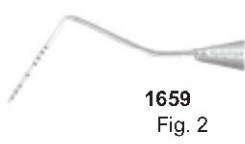
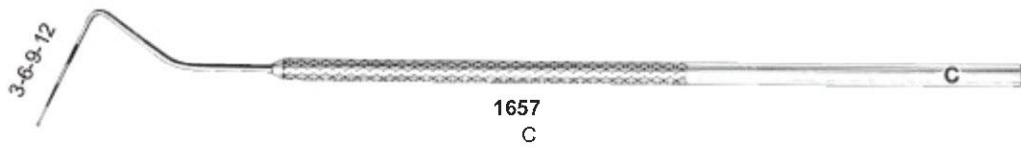
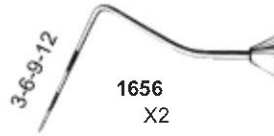
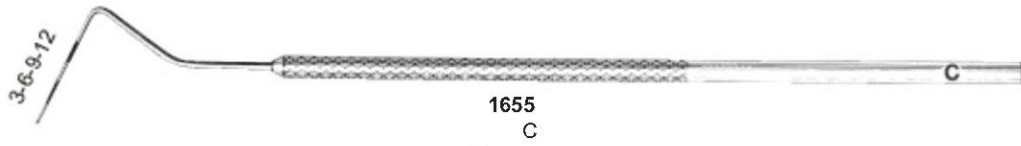





Probes

**Probes Double Ended-Standard**

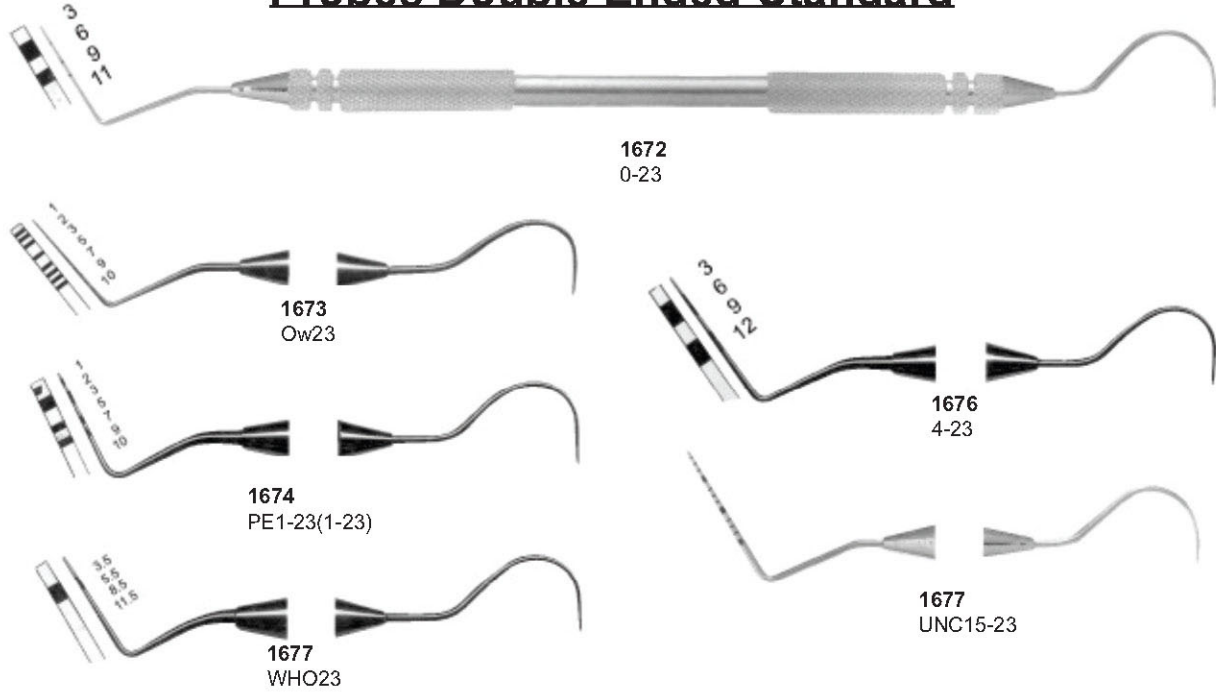

**Probes Double Ended YACTILE TONE**

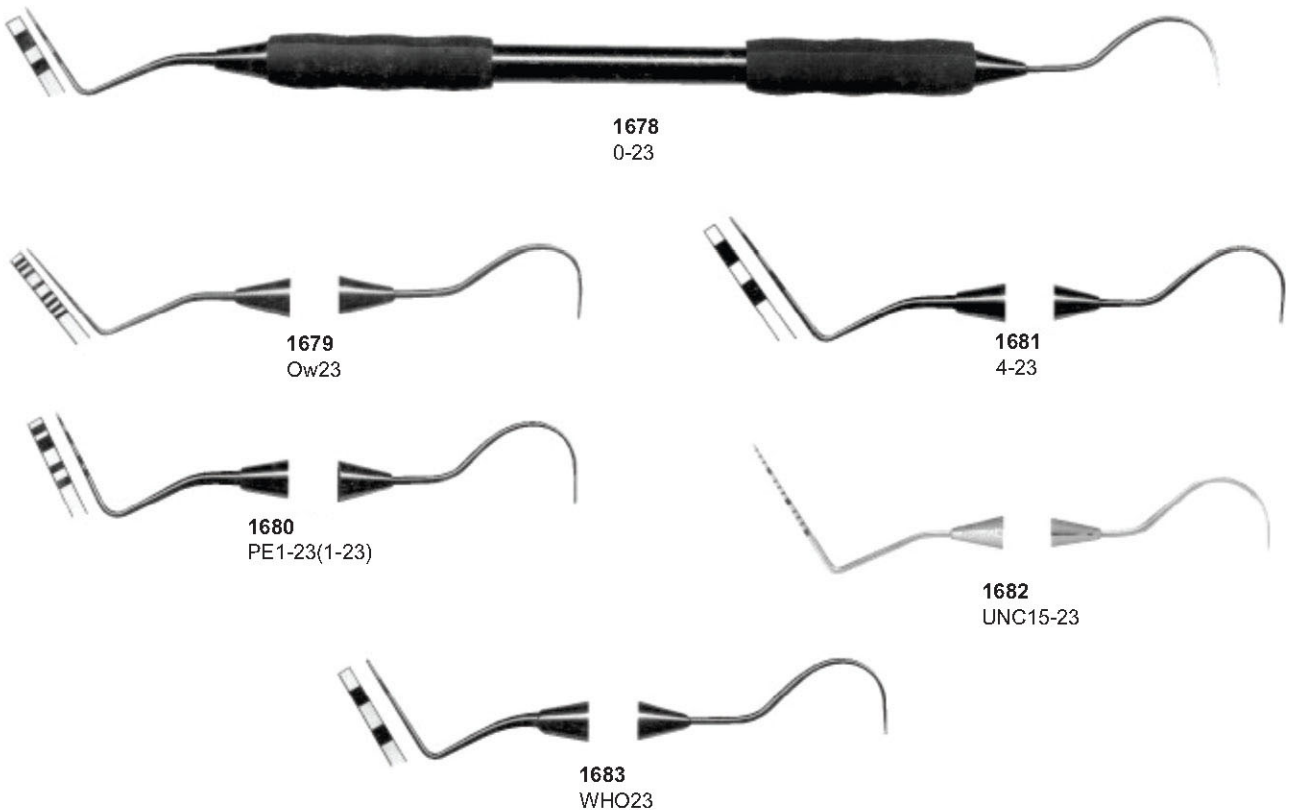



# Endodontic Condensers

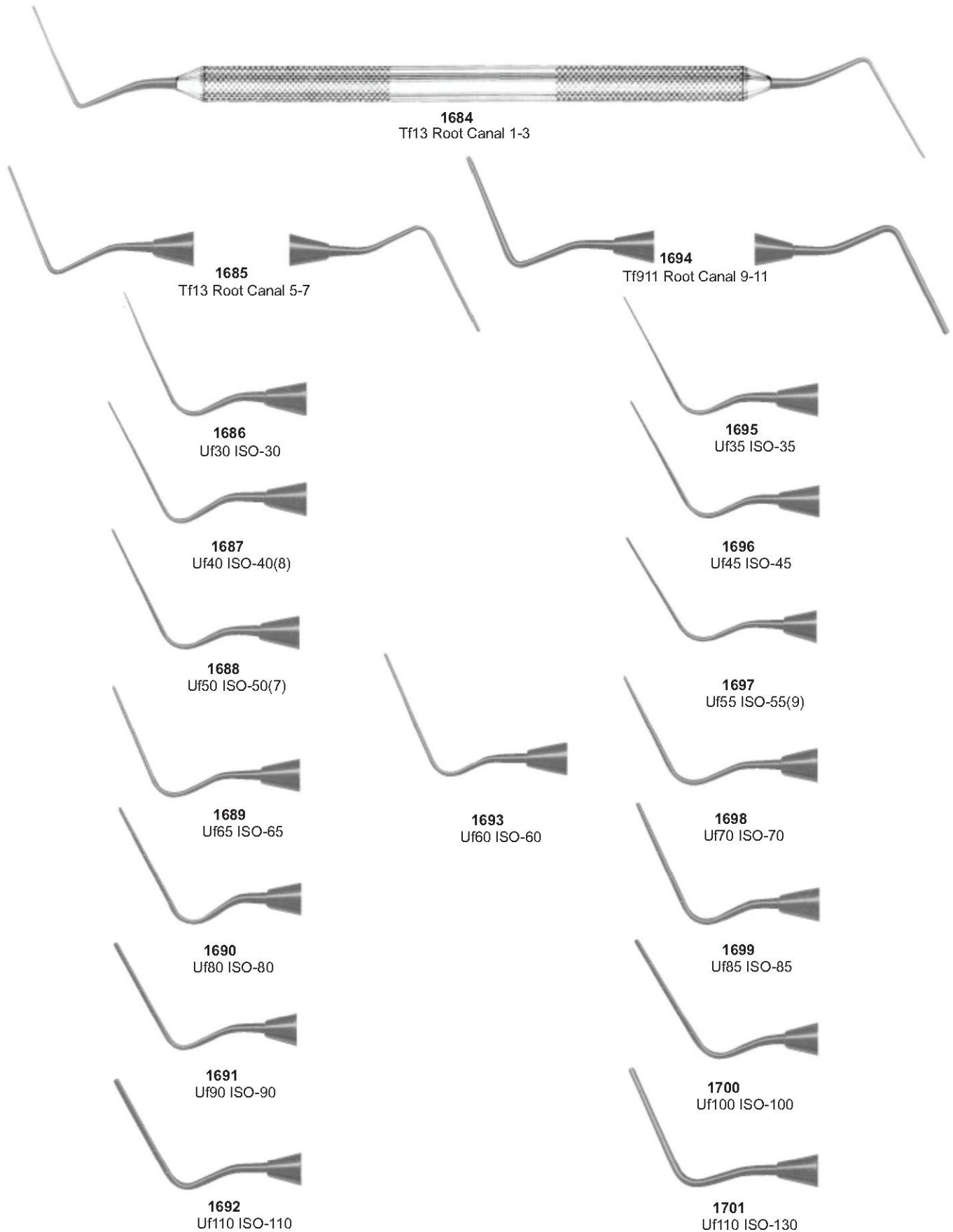



# Endodontic Condenders/Spreaders



1702  
UF102X



1703  
UF45N



1704  
Uf60n



1705  
Uf80n



1706  
UF102X



1702  
Ur25 R-25



1708  
Ue30 R-30



1709  
Ue35 R-35



1770  
Ue40 R-40



1711  
Ue45 R-45



1712  
Ue50 R-50



1713  
UF120X



1714  
UF140X



1715  
TFD3545B

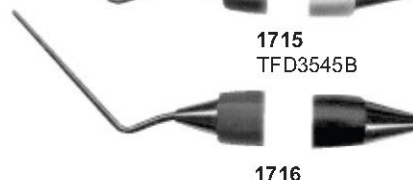

1716  
TFD6080B

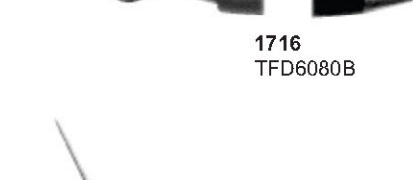

1717  
Ue55 R-55



1782  
Ue60 R-60



1719  
UE25N R-25



17020  
UE30N R-30



1721  
UE40N R-40





## Obturation Instruments

**1722**  
No.D11



**1723**  
No.D11T



**1724**  
No.DKR1



**1725**  
No.25S



**1726**  
No.W1S



**1727**  
No. W2S

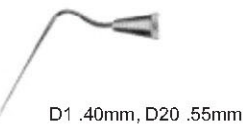

**1732**  
No. 5, D(1mm).50mm, .55mm D(5mm)  
D(16mm),85mm, .75mm D(16mm)

**1733**  
No. 7, D(1mm).70mm, .50mm D(5mm)  
D(16mm),1.00mm, .75mm D(16mm)

**1734**  
No. 9, D(1mm).1.00mm, .63mm D(5mm)  
D(16mm),1.30mm, .75mm D(16mm)

**1735**  
No. 11, D(1mm).1.20mm, .63mm D(5mm)  
D(16mm),1.50mm, .75mm D(16mm)

**1736**  
No. 1, (D1 .35mm. D26 .75mm)

**1737**  
No. 2, (D1 .55mm. D16 .85mm)

**1738**  
No. 3, D1 .85mm. D16 1.15mm

**1739**  
No. 4, D1 1.00mm. D16 1.30mm

**1740**  
No. 1-3, D1 .25mm/D11 .35mm

**1741**  
No. 3-5-D1 .35mm/D1 .55mm

**1742**  
No. 5-7-D1 .55mm/D1 .70mm

**1743**  
No. 9-11-D1 1.00mm/D1 1.20mm



# Elevators

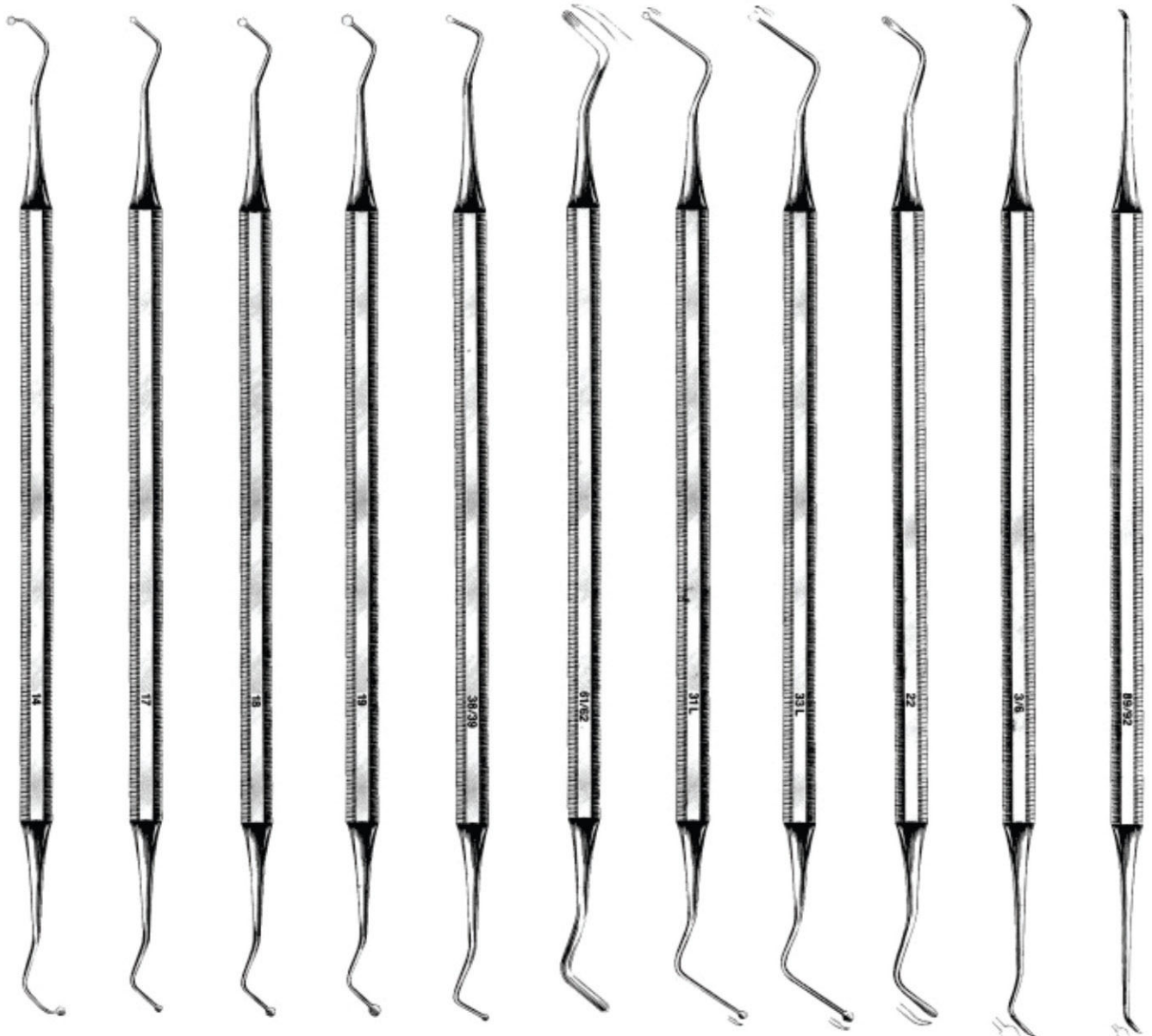

1744  
No. 14

1745  
No. 17

1746  
No. 18

1747  
No. 19

1748  
No. 38/39

1749  
No. 61/62

1750  
No. 31L

1751  
No. 33L

1752  
No. 22

1753  
No. 3/6

1754  
No. 89/92



# Elevators



**1755**  
1mm Discois (10-7-14)



**1756**  
1mm Discois (38-39) (11.5-7-17)



**1757**  
E2 Discois (15-9-15)



**1758**  
1.5mm Discois (15-8-14)



**1759**  
E3 Discois (25-9-15)



**1760**  
2mm Discois (20-9-14)



**1761**  
1.5mm Spoon (15-8-14)



**1762**  
E1 Discois (12-9-15)



**1763**  
2mm Spoon (20-9-14)



**1755**  
17 Tear-Drop



**1765**  
19 Tear-Drop



**1766**  
18 Tear-Drop



**1767**  
20 Tear-Drop





# Elevators, Explorer / Probes

## Elevators

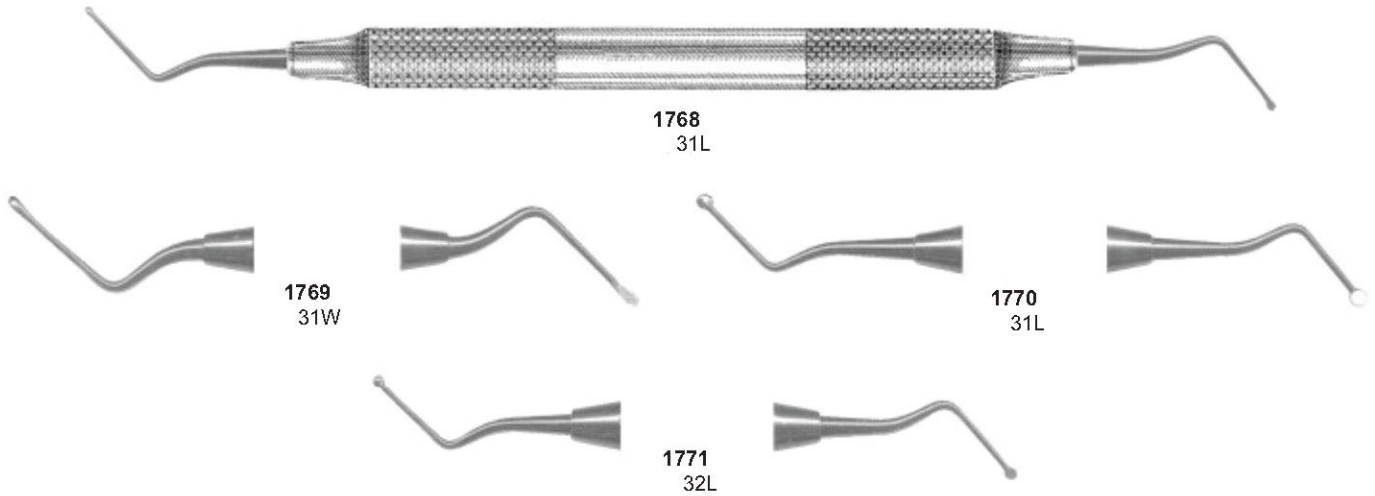

## Explorers/Probes

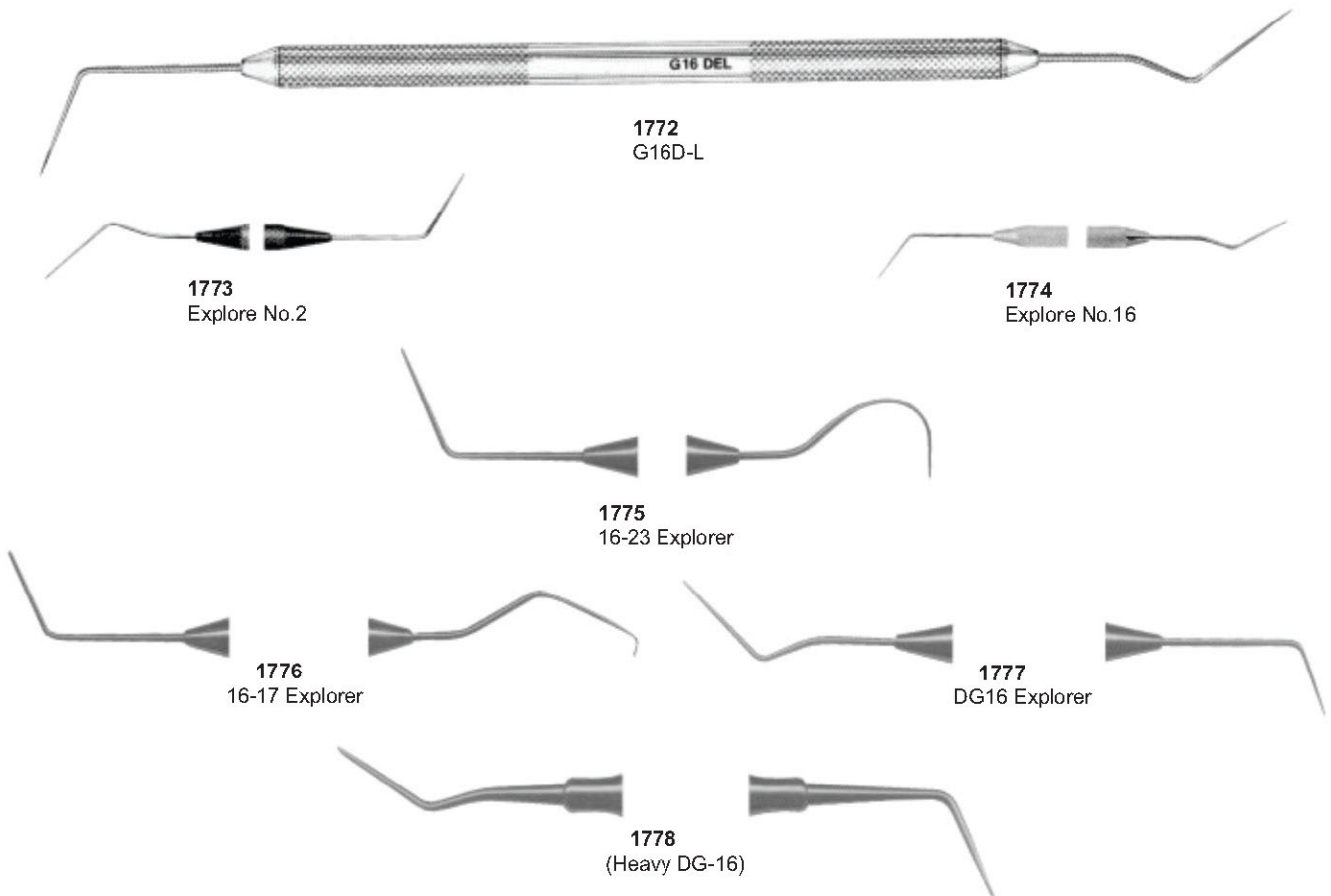



Explores







# Explorer

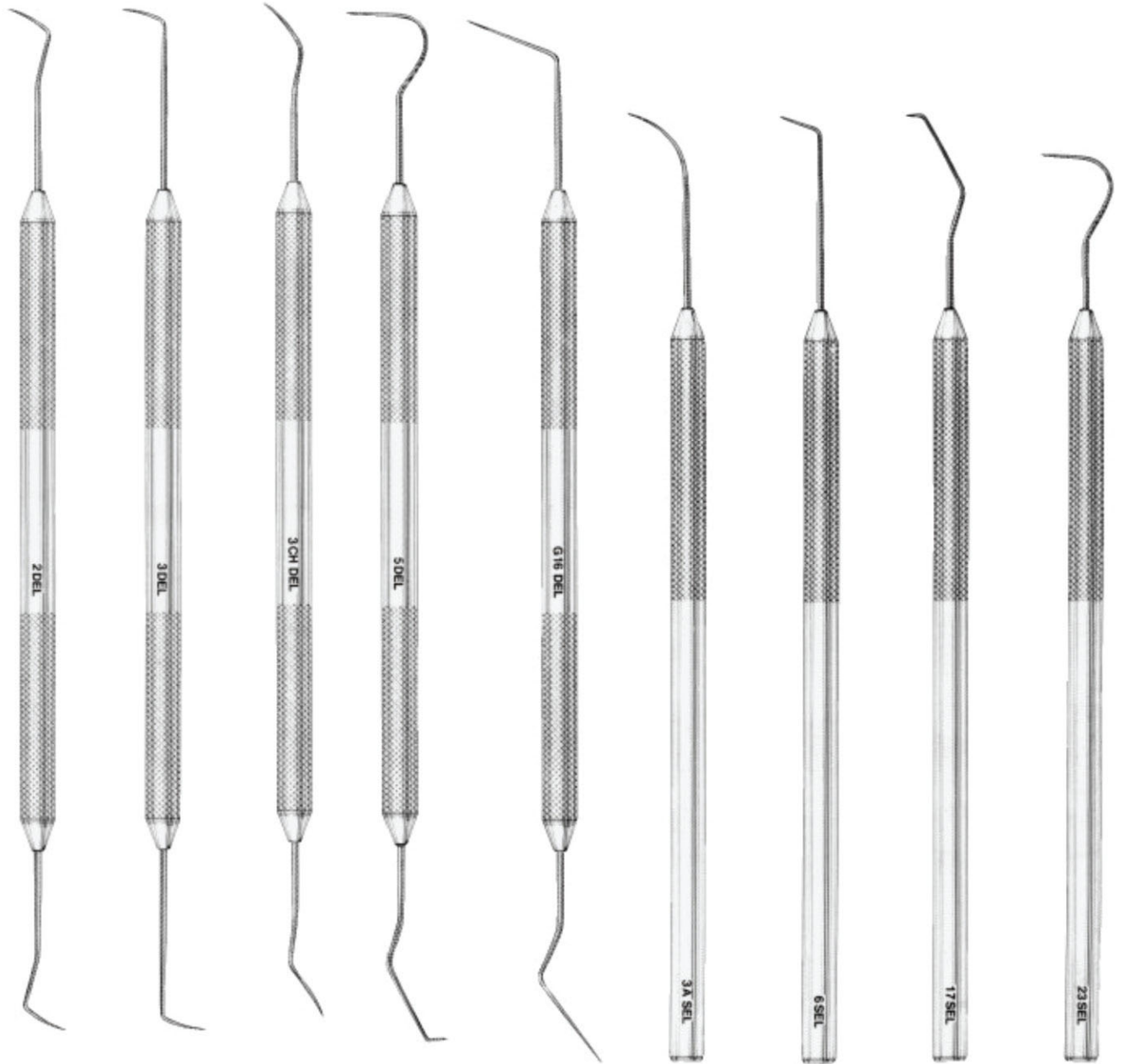

1790  
No. 2D-L

1791  
No. 3D-L

1792  
No. 3DHD-L

1793  
No. 5D-L

1794  
No. G16D-L

1795  
No. 3AS-L

1796  
No. 6S-L

1797  
No. 17S-L

1798  
No. 23S-L



## Explore / Probes Combination



**1799**  
Gf17 Probes/Explorer

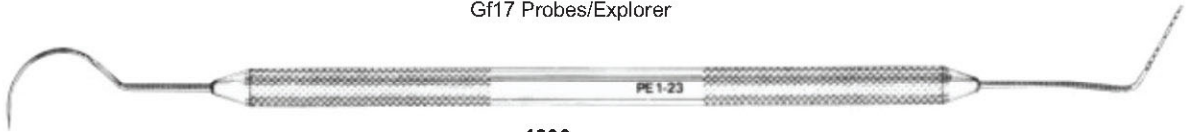

**1800**  
PE 1-23 Probes/Explorer



**1801**  
Probes 0 / 23 Explorer(fine)



**1802**  
Probes 1 / 23 Explorer



**1804**  
Probes 4 / 23 Explorer



**1803**  
Probes OW / 23 Explorer



**1802**  
Ball Tip Probe WHO / 23 Explorer

## Probes



**1806**  
Gf18 Probe

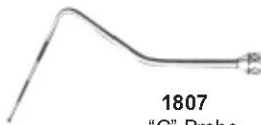

**1807**  
"C" Probe

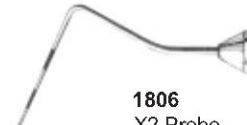

**1806**  
X2 Probe



**1809**  
1-2 (Probe 2 end is flat)

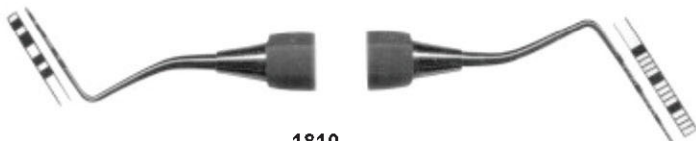

**1810**  
1 UNC 15



**1811**  
4 SE



# Cord Packers, Hatchets, Hoes

## CARD PACKERS



1812

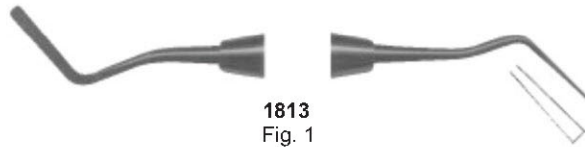

1813  
Fig. 1



1814  
Fig. 2



1815  
BLOOMFIELD  
Fig. 2 (off angle)



1816  
Fig. 1



1817  
CSI-1 (slightly serrated on ends)



## HATCHETS



1818  
1mm (10-7-14)



1819  
1.3mm (13-10-16)



1820  
1.5mm (15-8-14)



## HOSE

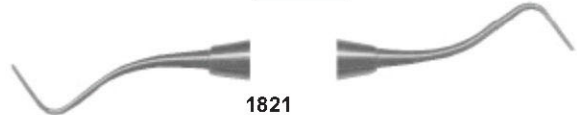

1821  
1mm (10-8-16)



1822  
UHW 18-19



1823  
UHW 16-18



1824  
UHW 20-21



### P.K.Thomas waxing & Gracey Cutters Set



1825  
P.K Thomas 1



1826  
P.K Thomas 2



1827  
P.K Thomas 3



1828  
P.K Thomas 4



1829  
P.K Thomas 5

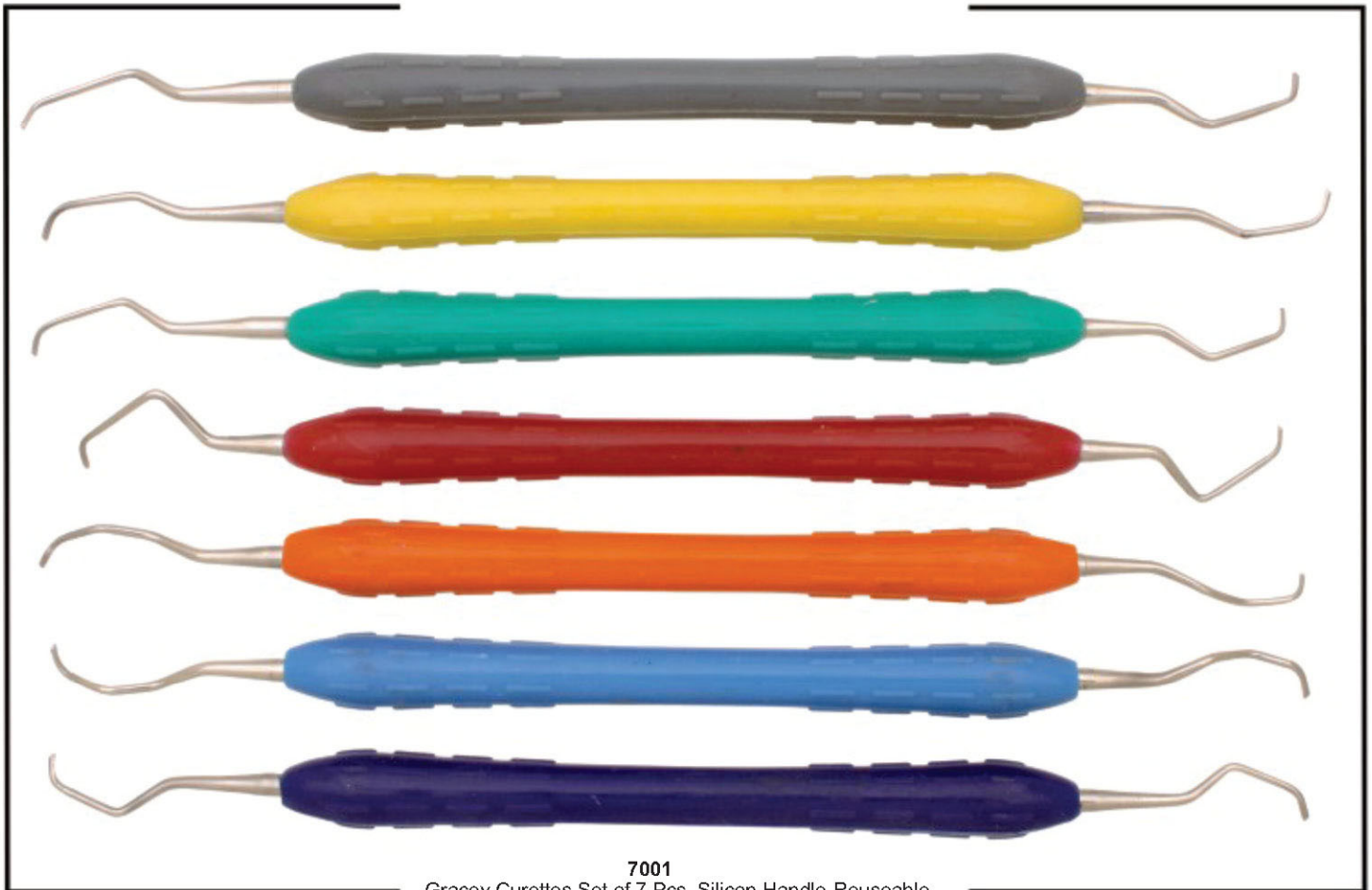

7001  
Gracey Currettes Set of 7 Pcs, Silicon Handle-Reuseable



Amalgam Pluggers / Condenseres / Applocators



1830  
BEHAMAN (Fig.1)



1831  
BLACK (Fig.1-2)



1832  
MORQUETTE (Fig.0/1)



1834  
Hollenback No. 1 Plugger



1835  
Hollenback No. 2 Plugger



1833  
Black Action 11/12 Plugger



1833  
Hollenback No. 3 Plugger



1837  
Blacks 0-1 (1mm-1.5mm)



1838  
Blacks 1-2 (1.5mm-2.5mm)



1843  
.7mm-1mm



1839  
Blacks 1 (.7mm-1mm)



1840  
Blacks 2 (1.5mm-2mm)



1844  
1mm-1.5mm



1845  
1.5mm-2mm



1841  
2.5mm-3mm



1846  
Oregon (Fig.3)



1847  
Oregon (Fig.4)



1848  
UP 12



1842  
Oregon 2



1849  
Applicator 1-2



1850  
Birtles Applicator Spatula



1851  
Birtles Applicator Spatula K

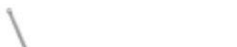



## Placement Instruments, Stopping Stoppers, Plugg

### Placement Instruments



**1852**  
PICH (Calocium Hydroxide Placery)

**1870**  
Birtles Applicator Spatula K



**1853**  
CA

### Stopping Stoppers



**1854**  
Woodson 2

Ø 1.6 mm



**1855**  
Woodson3S

Ø 2.4 mm

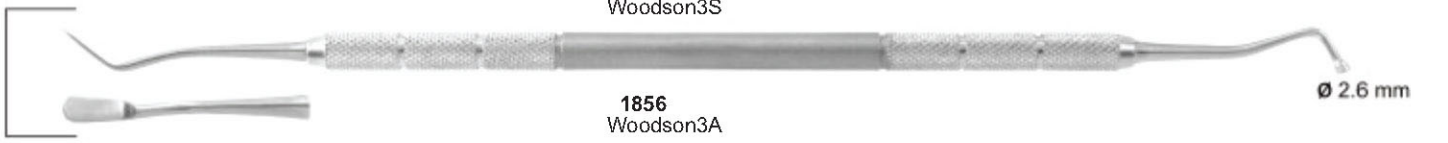

**1856**  
Woodson3A

Ø 2.6 mm



**1857**  
Woodson3

Ø 3.0 mm

### Pluggers



Ø 0.75 mm

**1858**  
Pluggers 1-4

Ø 1.2 mm



Ø 1.2 mm

**1859**  
Pluggers 1-4

Ø 1.6 mm



Ø 1.6 mm

**1860**  
Pluggers 4-6

Ø 2.0 mm

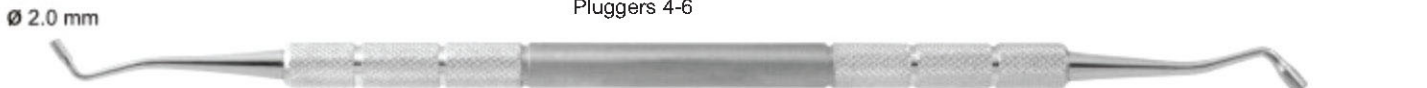

Ø 2.0 mm

**1861**  
Pluggers 6-8

Ø 2.5 mm

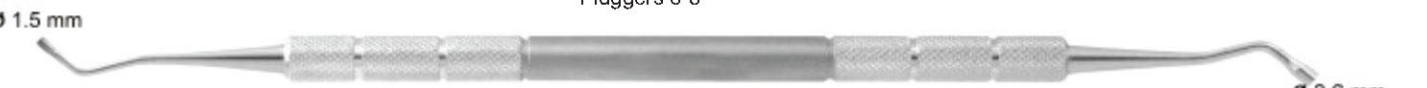

Ø 1.5 mm

**1862**  
Black 1-2

Ø 2.6 mm

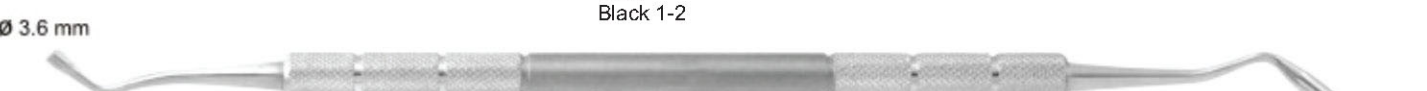

Ø 3.6 mm

**1863**  
Black 2-3

Ø 5.0 mm



**Burnishers**

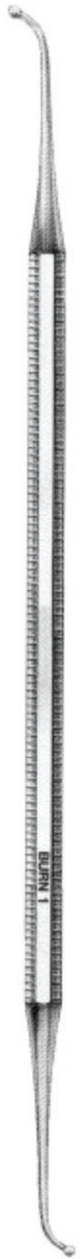

**1864**  
Fig. 1



**1865**  
Fig. 28/29



**1866**  
Fig. 34



**1867**  
Fig. 27/29

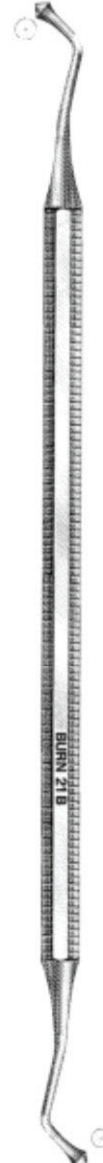

**1868**  
Fig. 21B



**1869**  
Fig. 21



**Burnishers**



**1870**  
21 Acom



**1871**  
Fig. 21B



**1873**  
Fig. 21C



**1872**  
Fig. 2-34



**1874**  
Fig. 26-28



**1875**  
Fig. 2-30



**1877**  
Fig. 27-29



**1871**  
Fig. 26-30



**1878**  
Fig. PKT 1



**1879**  
Fig. 21B



**1880**  
Fig. PKT 2



**1881**  
Fig. 34T



**1883**  
PKT 3



**1882**  
Fig. 3



**1884**  
PFI 21



**1885**  
PKT 3P



**1887**  
PKT 4



**1886**  
Pitts Pedo 19



**1888**  
Pitts Pedo 18



**1889**  
PKT 5







Wax Covers

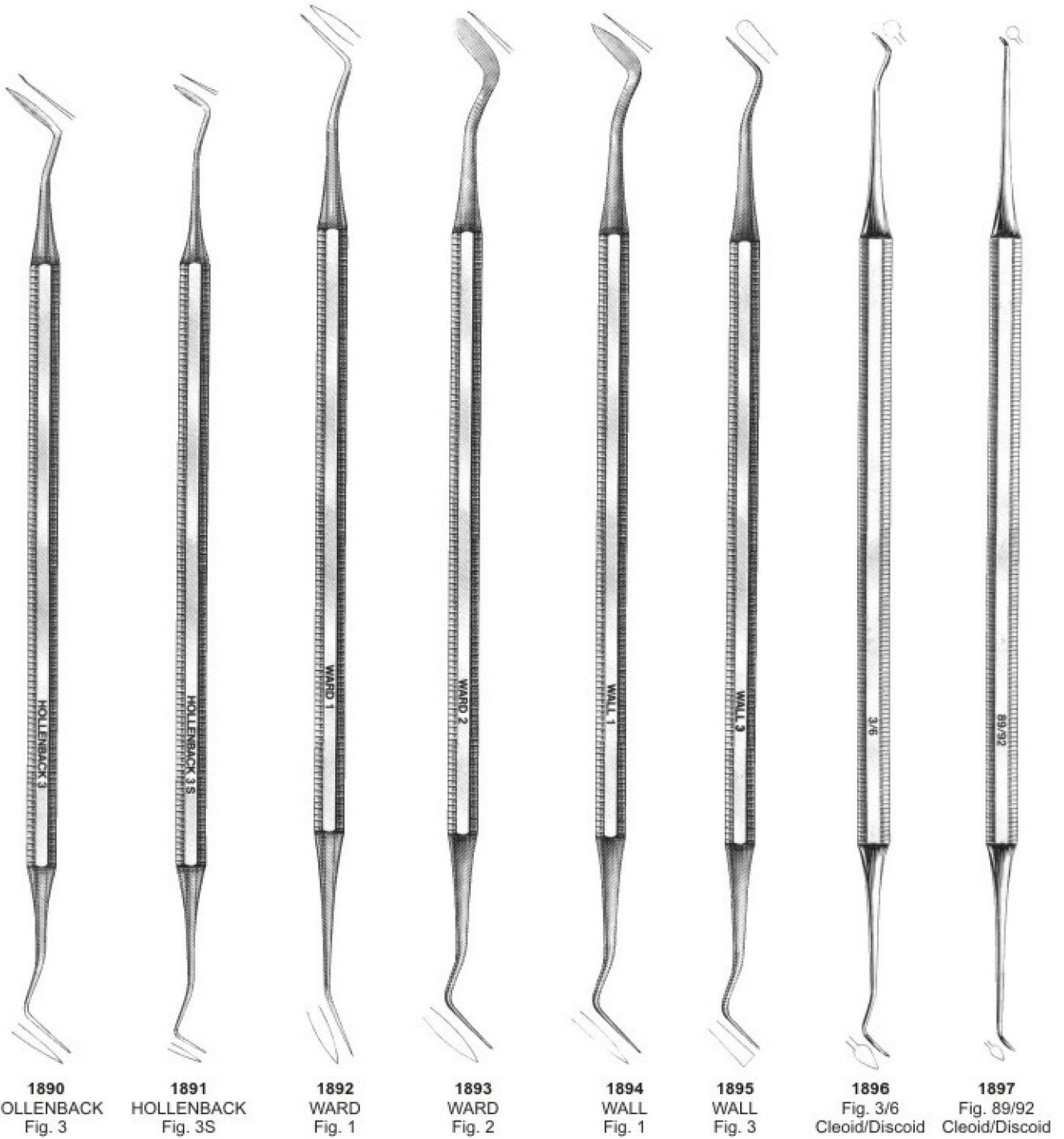



**Cavers**



**1898**  
1.5mm Cleoid Discoid (Shown with GTX Finish)



**1899**  
2mm Cleoid Discoid



**1901**  
3mm Cleoid Discoid



**1900**  
GOLLOBIN  
Fig. 1



**1902**  
HOLLENBACK  
Fig. 1/2



**190.**  
FRAHM  
Fig. 2-3 (off-angle)



**1904**  
HOLLENBACK  
Fig. 3



**1905**  
Interproximal 1

**1906**  
THOMPSON (Fig.3)  
(1/2 Hollenback Hoe & Tanner 3)



**1907**  
Interproximal 1

**1908**  
THOMPSON (Fig.5)  
(1/2 Hollenback Hoe & Tanner 5)



**1909**  
Baum Interproximal

**1910**  
THOMPSON (Fig.8)  
(3mm Cleoid 3 & Wall3)



**1911**  
Sho A Caever

**1912**  
THOMPSON (Fig.9)  
(Hollenback 3 & Wall3)



**1913**  
Thompson 2

**1914**  
WARD  
Fig. 1





**Cavers, Chisels**

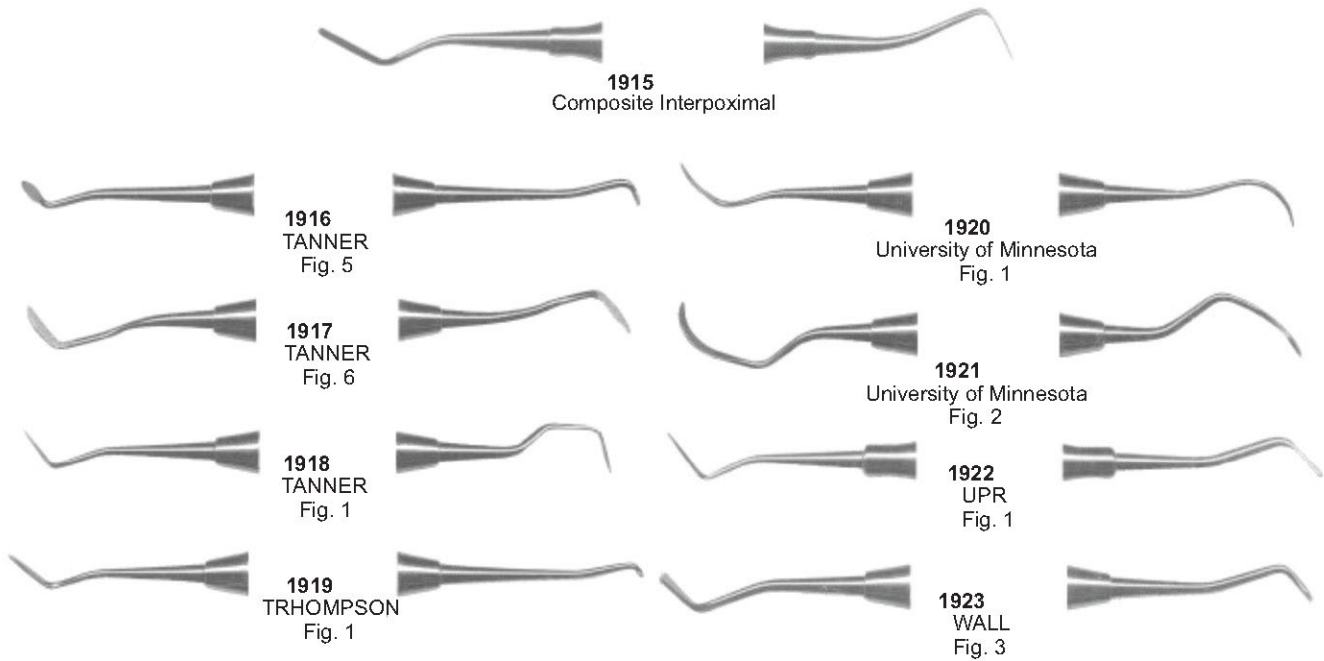

**Contour Carbide Catver-Finishing**

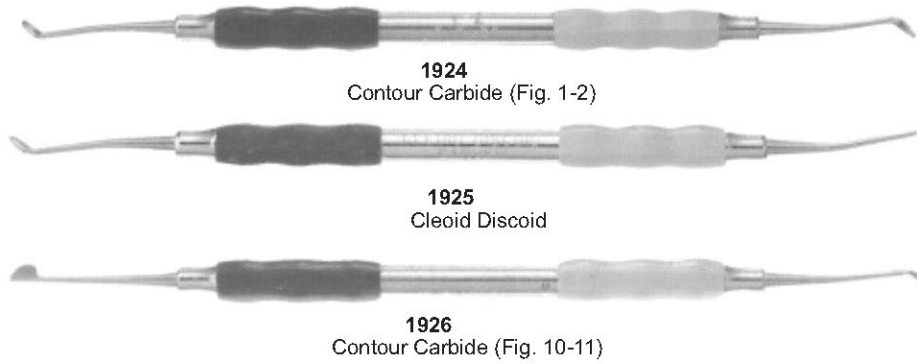

**Chisels**

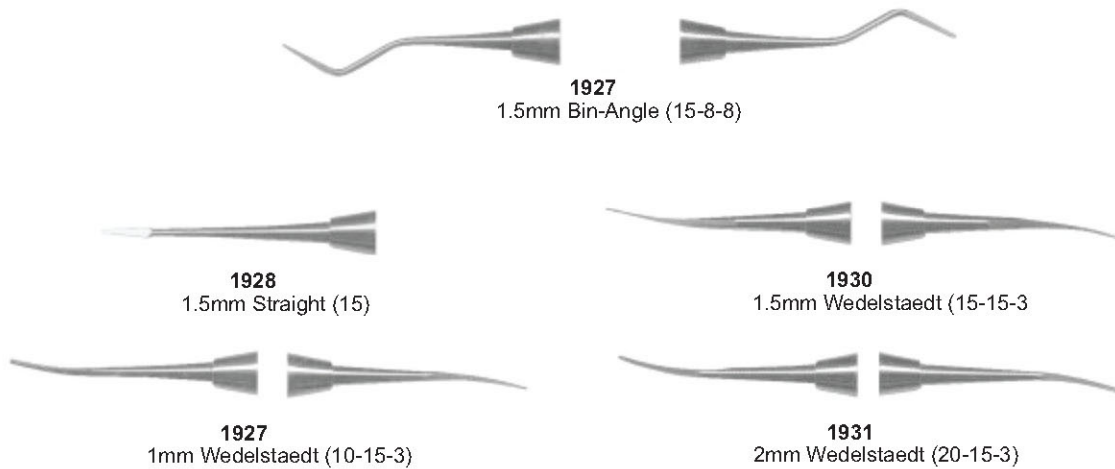



# Composite Placement

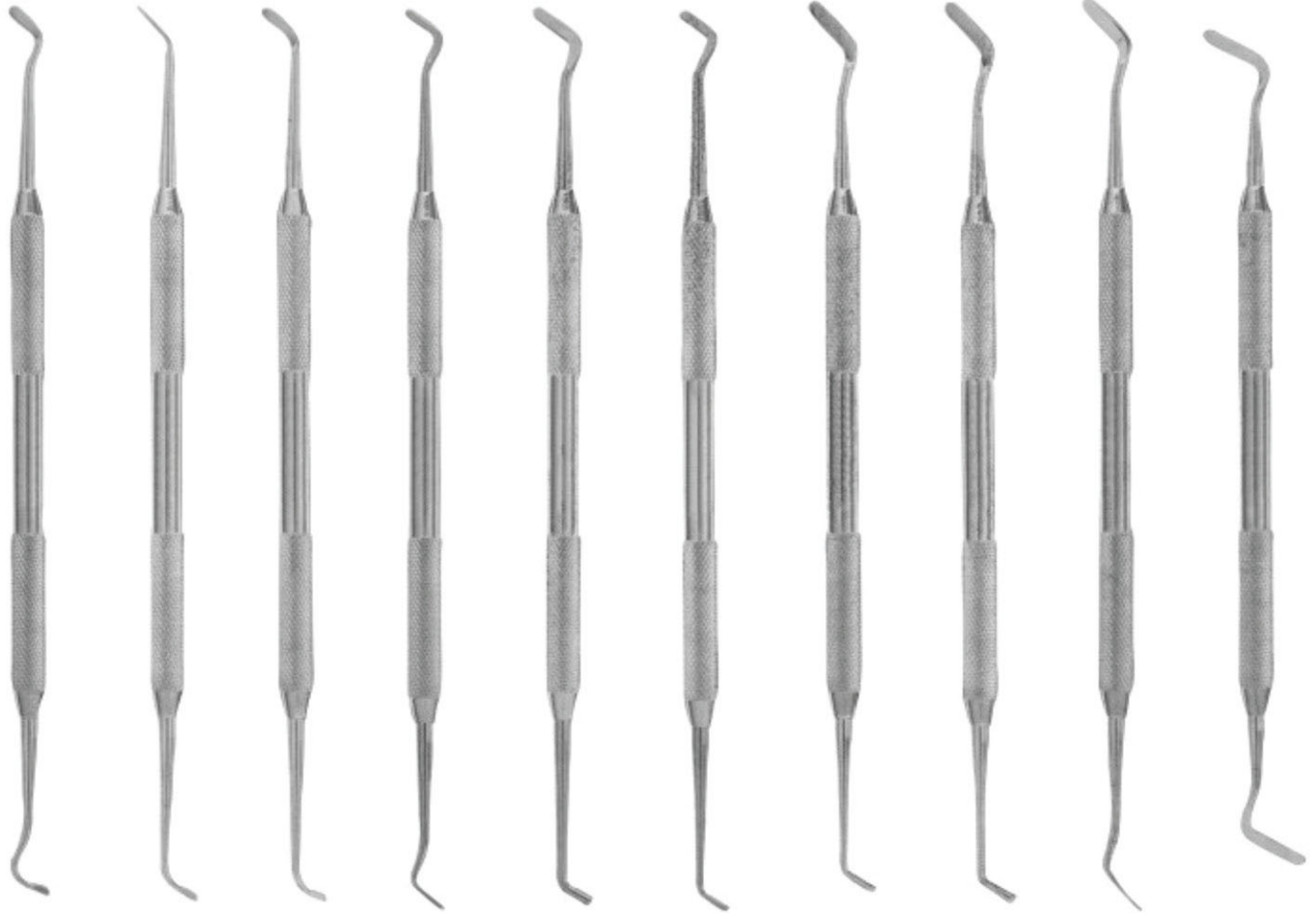

1932  
F-Type 1

1933  
F-Type 2

1934  
F-Type 3

1935  
F-Type 4

1936  
F-Type 5

1937  
F-Type 6

1938  
G-Type 1

1939  
G-Type 2

1940  
G-Type 3

1941  
G-Type 4

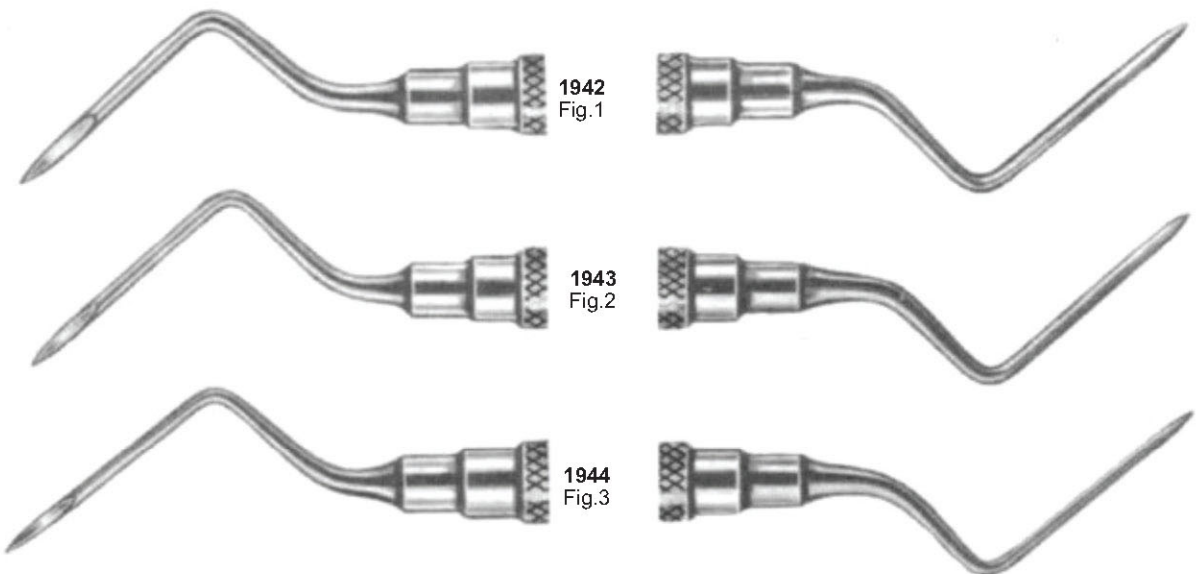

1942  
Fig.1

1943  
Fig.2

1944  
Fig.3



# Composite Placement



1945  
Fig.2



1946  
Fig.3 (off-set blade)



1954  
Fig.2



1947  
Fig.4



1955  
Fig.15



1948  
Fig.5



1953  
JORDAN  
Fig.2



1949  
Fig.3



1957  
FREEDMAN  
Fig.1



1950  
Fig.7



1958  
FREEDMAN  
Fig.2



1951  
Fig.8



1959  
FREEDMAN  
Fig.3



1952  
Fig.9



1960  
Dr. Dan



195.  
Fig.11



1961  
SIMON  
Fig.2



## K-Type

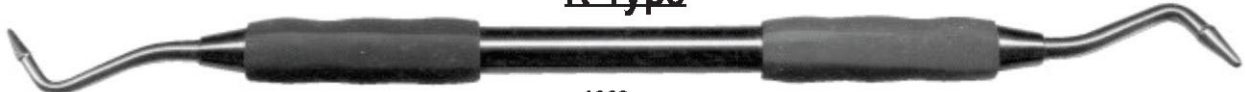

1962  
K-Type 1



1963  
K-Type 2



1965  
K-Type 4



1964  
K-Type 3



1966  
K-Type 5



1967  
K-Type 6 Carbide



# Plastic Filling Instruments



1968  
No.3

1969  
No.4

1970  
No.3

1974  
LANDMORE  
Fig. 3

1972  
WOODSON  
Fig. 1

1973  
WOODSON  
Fig. 2

1974  
WOODSON  
Fig. 3

1975  
W-3

1976  
Gregg  
4/5



# Plastic Filling Instruments



1977  
Fig. 5-7



1978  
Fig. 1



1979  
Fig. 3



1983  
GL/CK  
Fig. 1



1980  
Fig. 4



1984  
P8



1981  
Fig. 5-7



1985  
WOODSON  
Fig. 1



1982  
Fig. 8A



1986  
WOODSON  
Fig. 2



1987  
WOODSON  
Fig. 3





Curettes



1988  
GRACEY  
GC 1-2



1989  
GRACEY  
GC 3-4



1990  
GRACEY  
GC 5-6



1991  
GRACEY  
GC 7-8



1992  
GRACEY  
GC 9-10



1993  
GRACEY  
GC 11-12



1994  
GRACEY  
GC 13-14





# Gracey Curettes



1995  
G1-2



1995  
G3-4



1995  
G5-6



1995  
G7-8

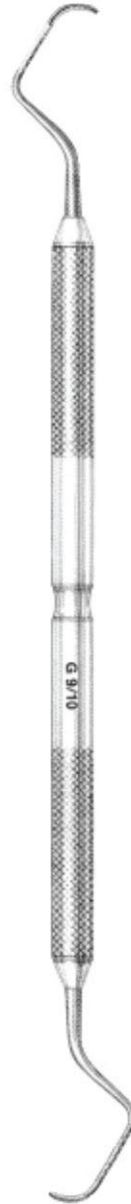

1995  
G9-10



2000  
G11-12

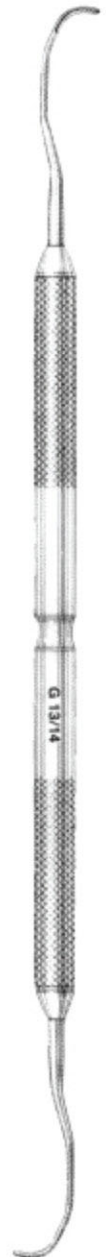

2001  
G13-14



### Curettes # 4 Handle

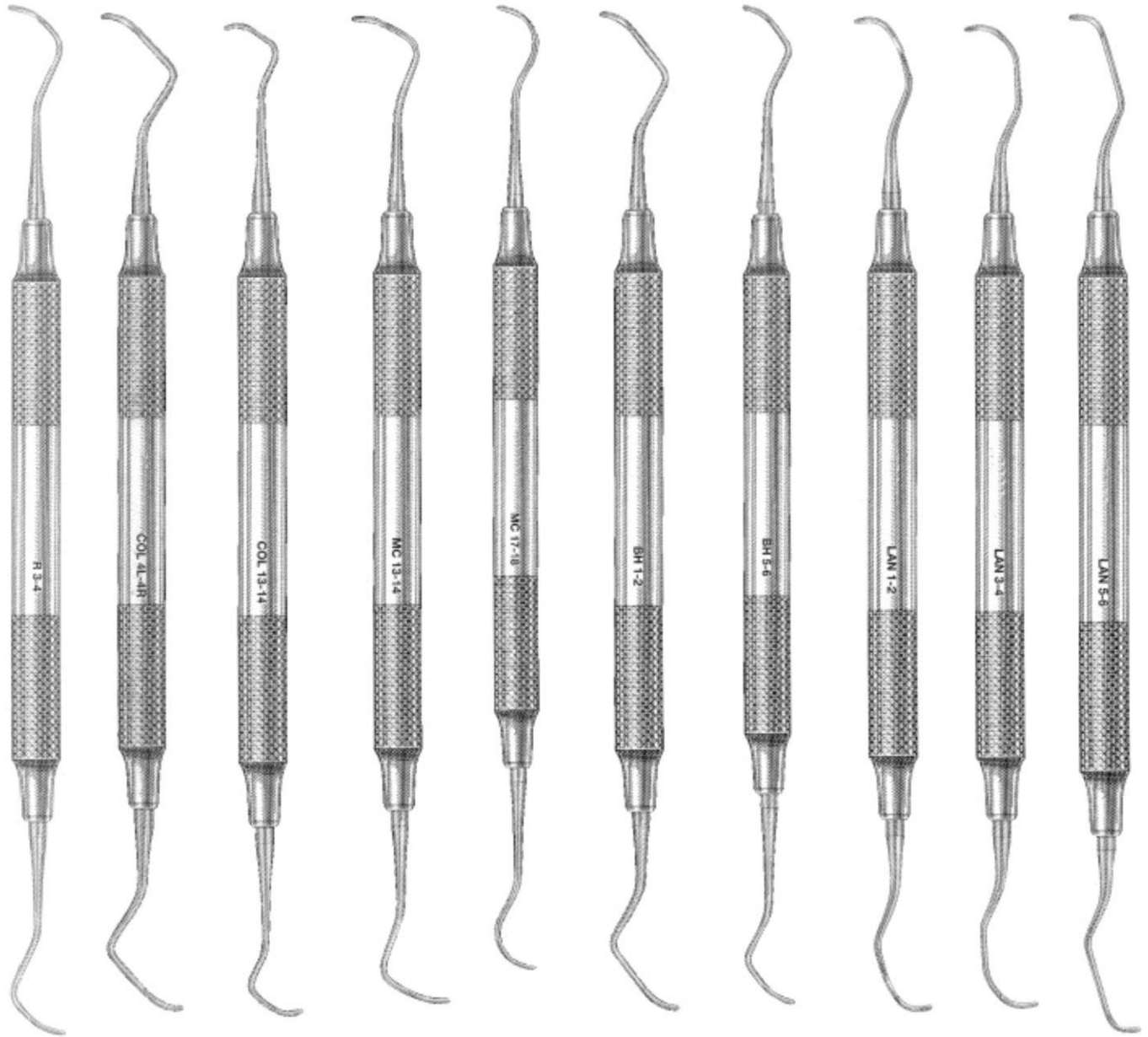

**2002**  
RULE  
3-4

**2003**  
COLUMBIA  
4R-4L

**2004**  
COLUMBIA  
13-14

**2003**  
MCCALLS  
13-14

**2006**  
MCCALLS  
17-18

**2007**  
BARNHART  
1-2

**2008**  
BARNHART  
5-6

**2009**  
LANGER  
1-2

**2010**  
LANGER  
3-4

**2011**  
LANGER  
5-6



# Curettes

## COLUMBIA CURETTES



2012  
4L-4R

2013  
13-14

2014  
2L-2R

## MCCALLS CURETTES



2012  
13-14

2012  
13S-14S

2012  
17-18

2012  
17S-18S



Curettes

**GOLDMAN FOX**



2019  
GF1 Universal Svaler



2020  
GF2 Curette



2021  
GF3 Curette



2022  
GF4 Curette



2025  
GF5 Hoe



2024  
GF6 Hoe



Curettes

**GOLDMAN FOX**

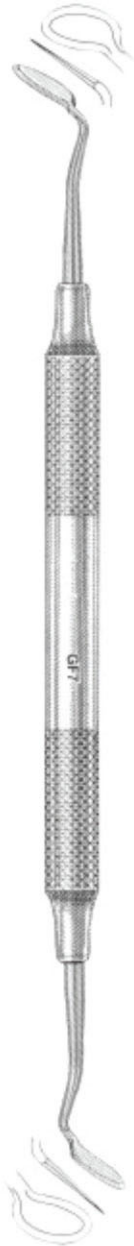

**2025**  
GF 7 Knife



**2026**  
GF 8 Spear Knife



**2027**  
GF 9 Knife Scaler



**2028**  
GF 11 Spear Knife



**2029**  
GF 21 Sharp Spoon/  
Small Scaler



## Knives, Interproximal Files



**2030**  
Kirkland 15 / 16



**2031**  
Ordan 1 / 2



**2032**  
Buck 3 / 4



**2033**  
Buck 5 / 6

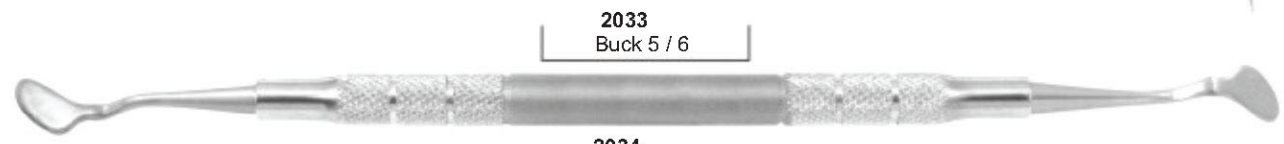

**2034**  
Goldman-Fox 7



**2035**  
Goldman-Fox 8

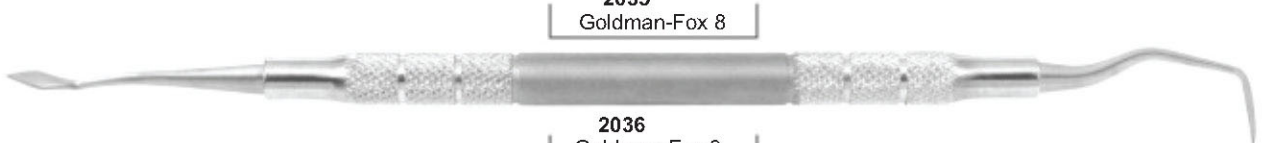

**2036**  
Goldman-Fox 9



**2037**  
Goldman-Fox 11

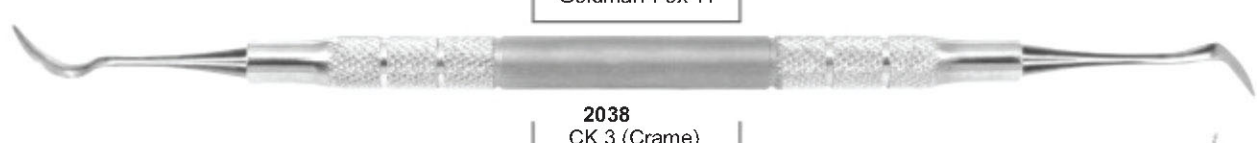

**2038**  
CK 3 (Crame)

### Interproximal Files



**2039**  
Sugaeman 1S-2S

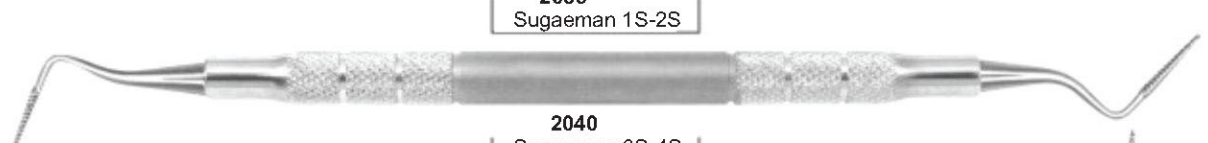

**2040**  
Sugaeman 3S-4S



**2041**  
Schluger 9-10



**2042**  
Buck 11-12



## Curettes, Root Planing Curettes



2043  
COLUMBIA (2L-2R)

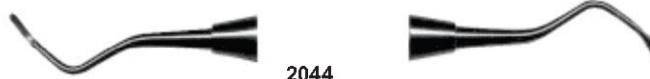

2044  
MCCALL (13-14)

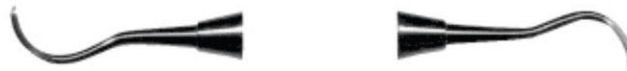

2045  
MCCALL (17S-18S)

### Root Planning Curettes



2046  
Root Plane (1-2)



2047  
Root Plane (5-6)



2049  
Root Plane (11-12)



2048  
Root Plane (7-8)

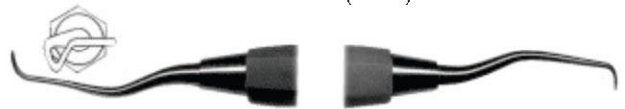

2050  
Root Plane (13-14)



2051  
Petite (1-2)



2052  
Petite (11-12)



2053  
Petite (5-6)



2054  
Petite (13-14)



# Curettes



2055  
BARNHART (1-2)



2056  
BARNHART (5-6)

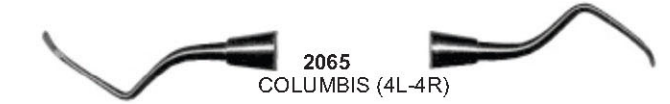

2065  
COLUMBIS (4L-4R)



2057  
GRACEY (1-2)

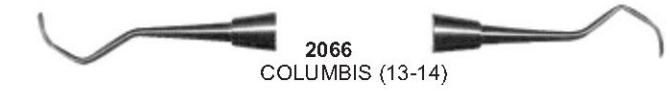

2066  
COLUMBIS (13-14)

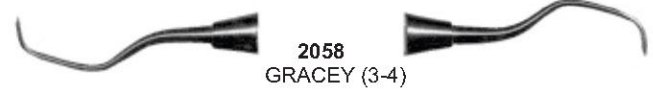

2058  
GRACEY (3-4)



2067  
LANGER (1-2)

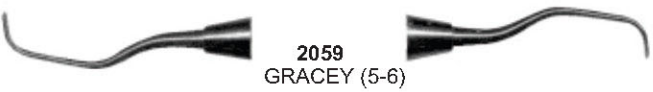

2059  
GRACEY (5-6)



2068  
LANGER (3-4)

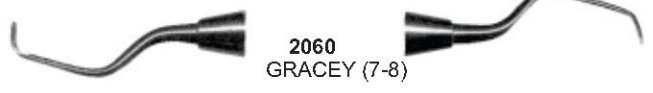

2060  
GRACEY (7-8)



2069  
LANGER (5-6)



2061  
GRACEY (9-10)

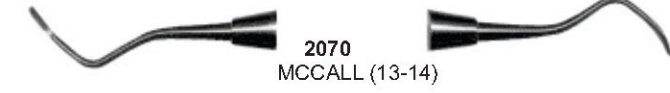

2070  
MCCALL (13-14)



2062  
GRACEY (11-12)



2071  
MCCALL (13S-14S)

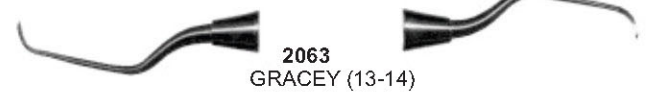

2063  
GRACEY (13-14)

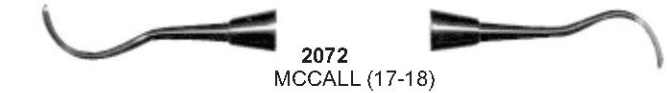

2072  
MCCALL (17-18)



2064  
GRACEY (2L-2R)

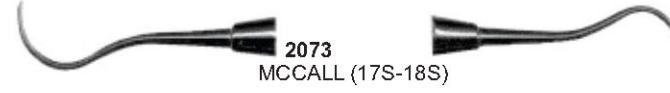

2073  
MCCALL (17S-18S)



2074  
RULE (3-4)







Dental Products

Silicon Handles-Reusable

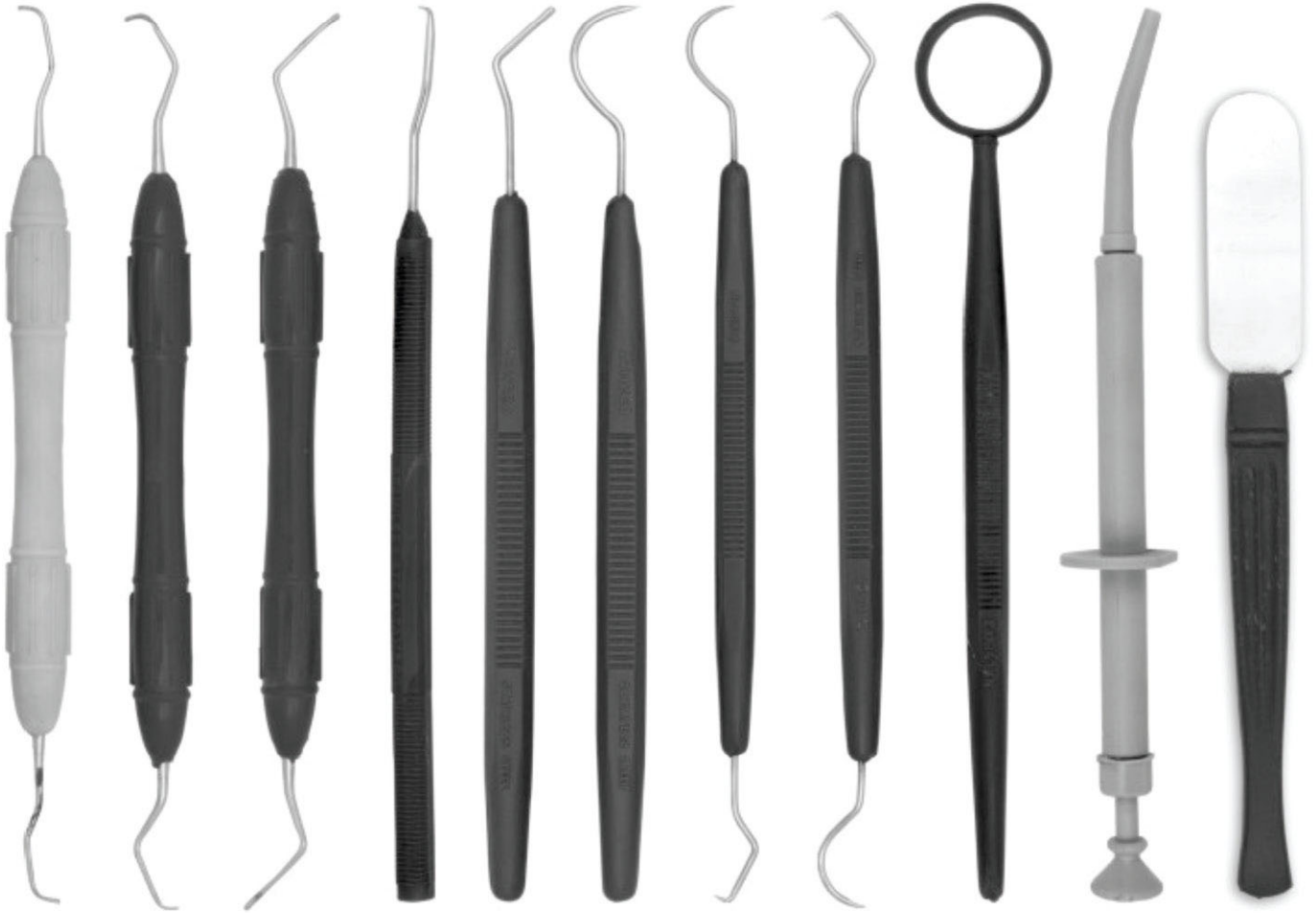

2075 2076 2077 2078 2079 2080 2081 2082 2083 2084 2085



2086 2087 2088 2089 2090



Wax, Porcelain & Cement Instruments

Comfort Grip  
Vinyl-Covered Insulating Handles

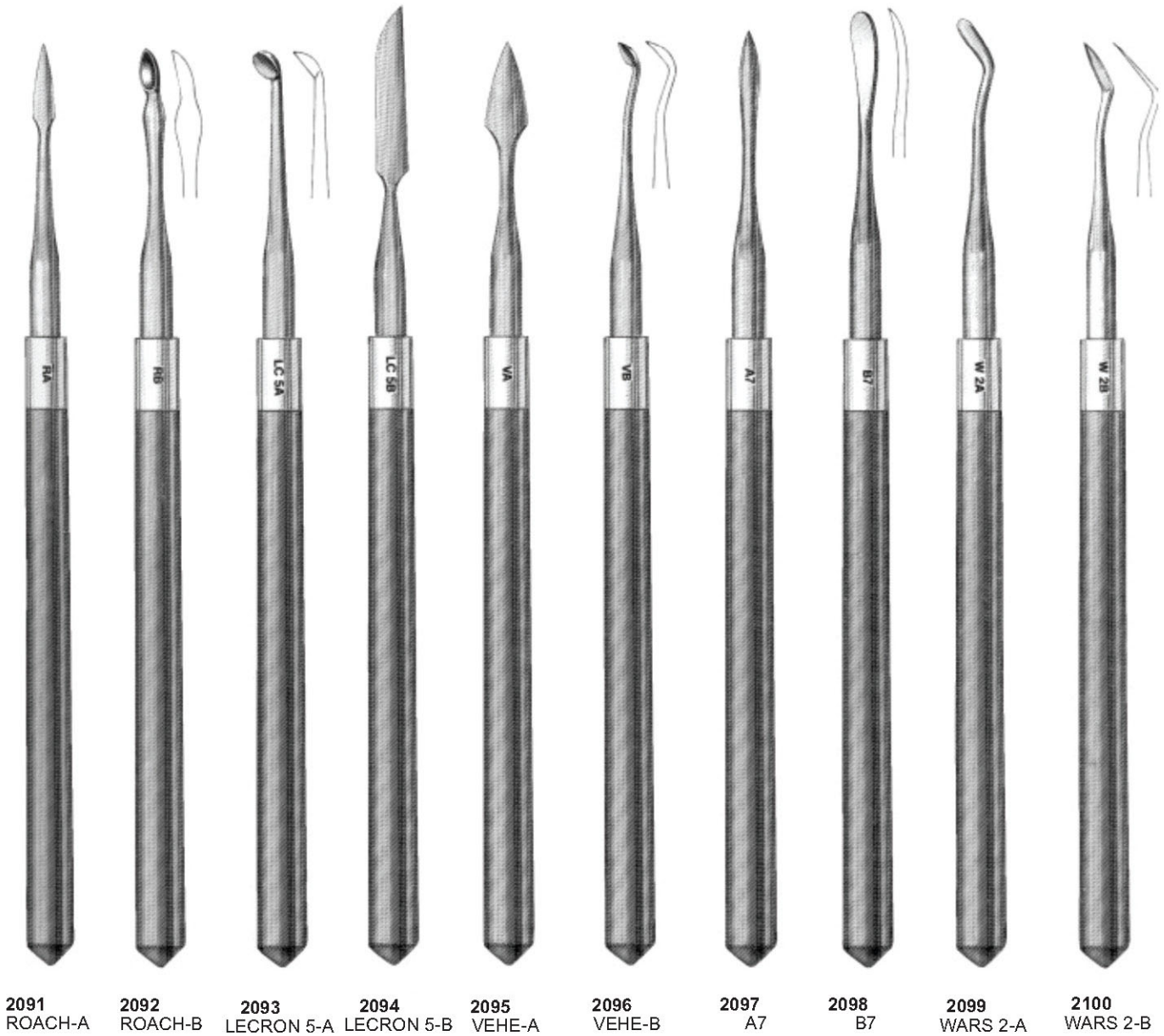



# Wax, Porcelain & Cement Instruments

## P.K THOMAS

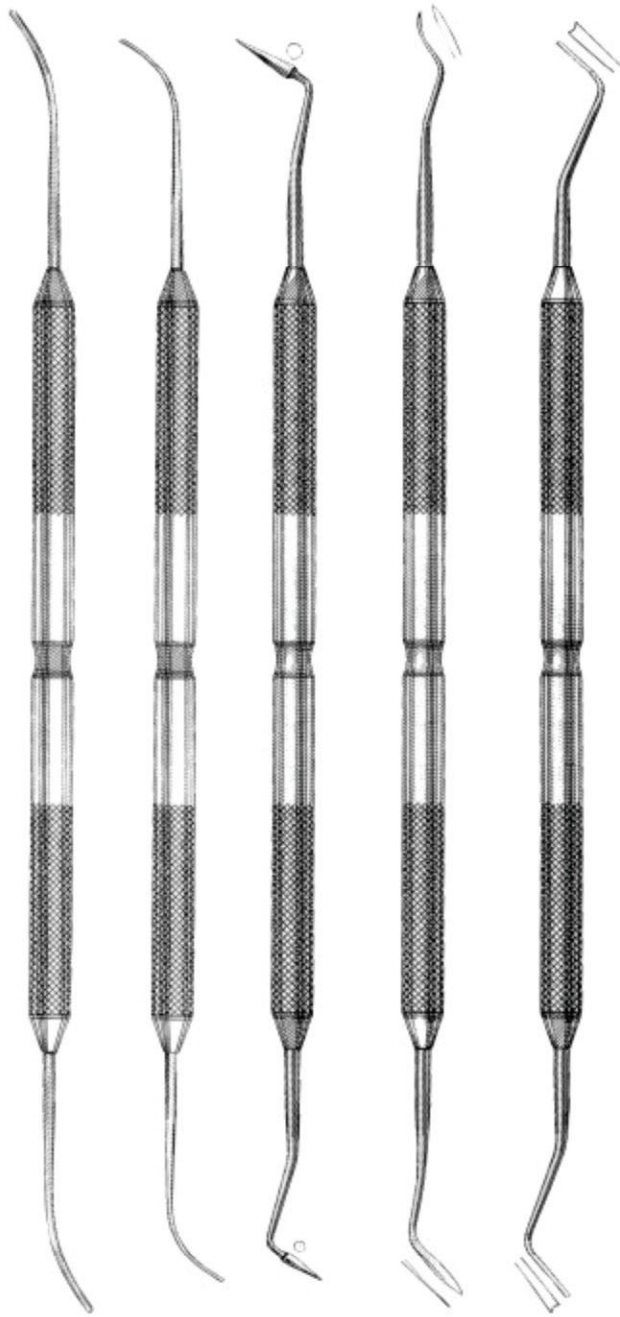

2101 PKT 1    2102 PKT 2    2103 PKT 3    2104 PKT 4    2105 PKT 5

Set of 5 Instruments

## WAX CARERS

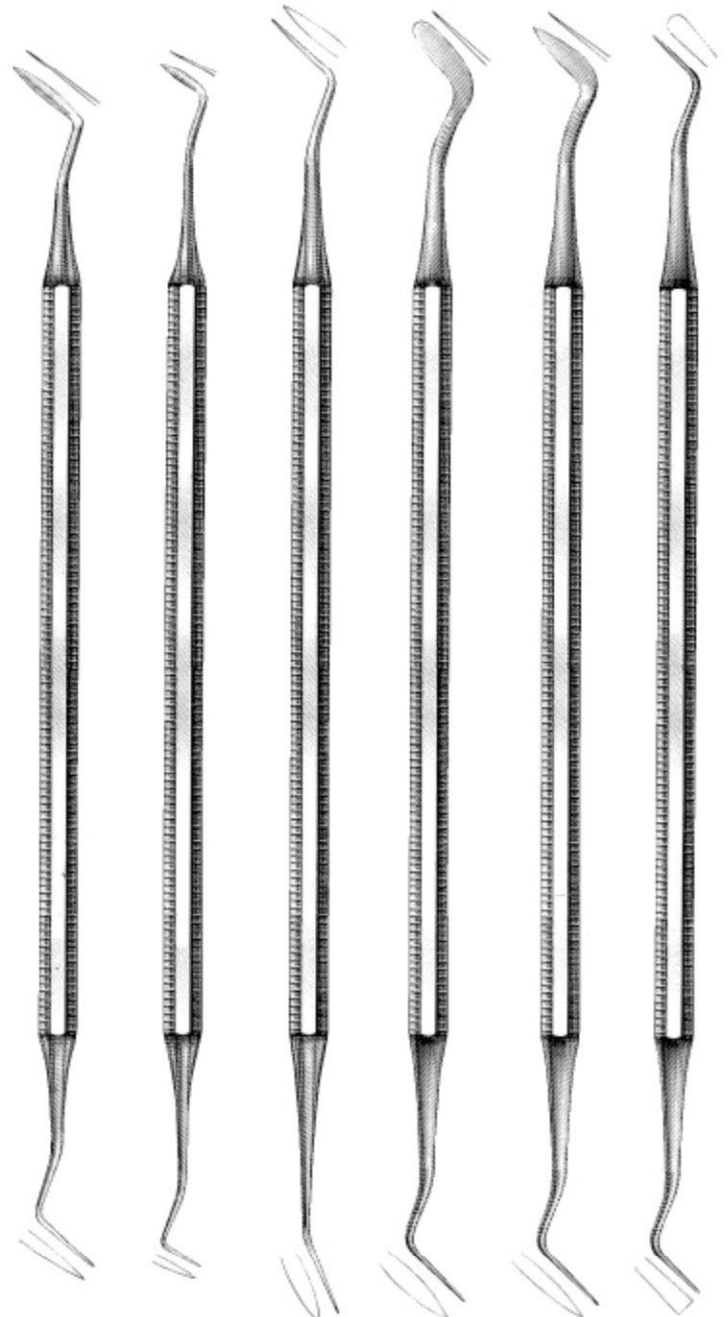

2106 Hollenback 3    2107 Hollenback 3S    2108 WARD 1    2109 WARD 2    2110 WALL 1    2111 WALL 3



## Wax & Modeling Cement Spatulas

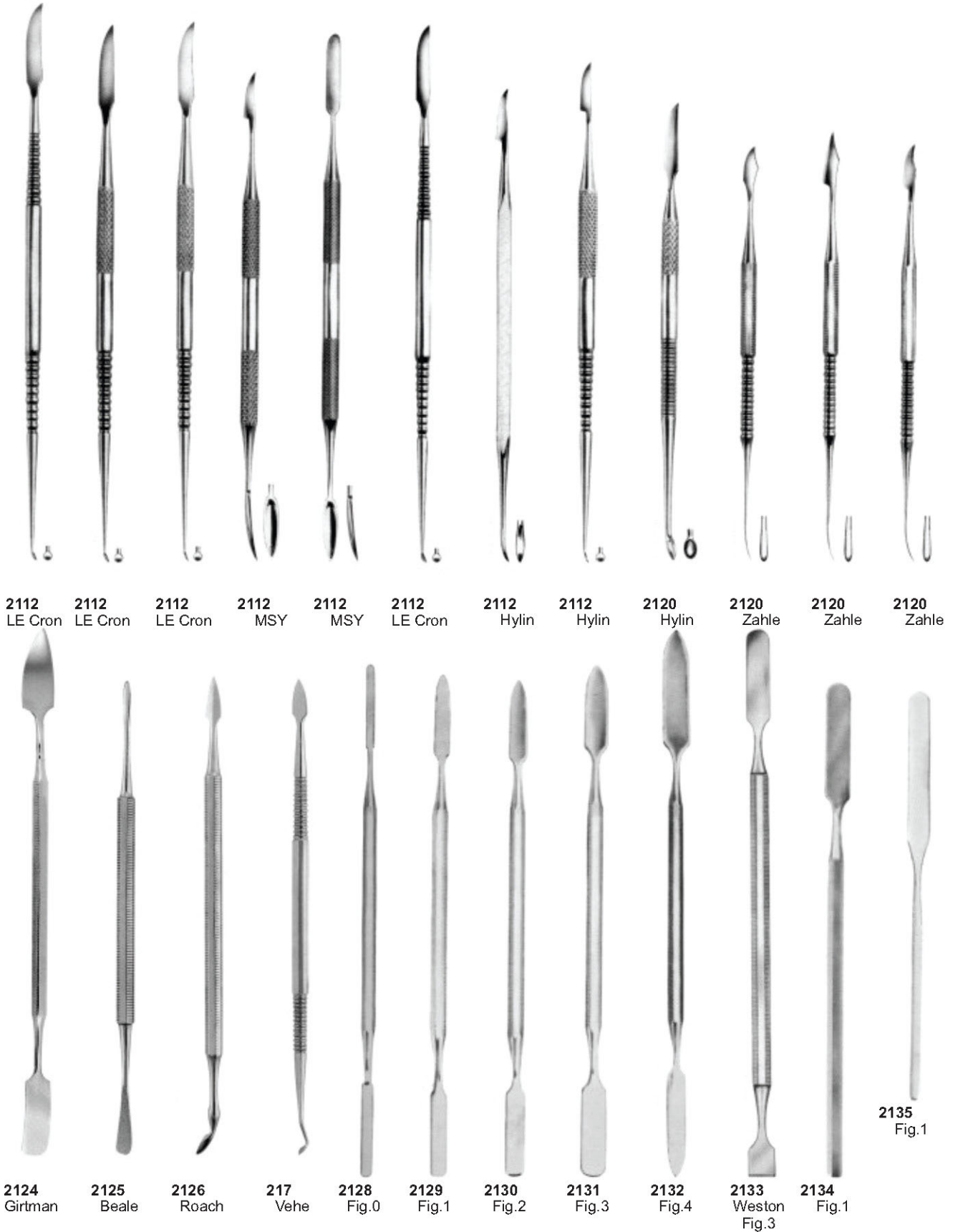



## Wax, Porcelain & Cement Instruments

### WAX & PORCELAIN CARVERS

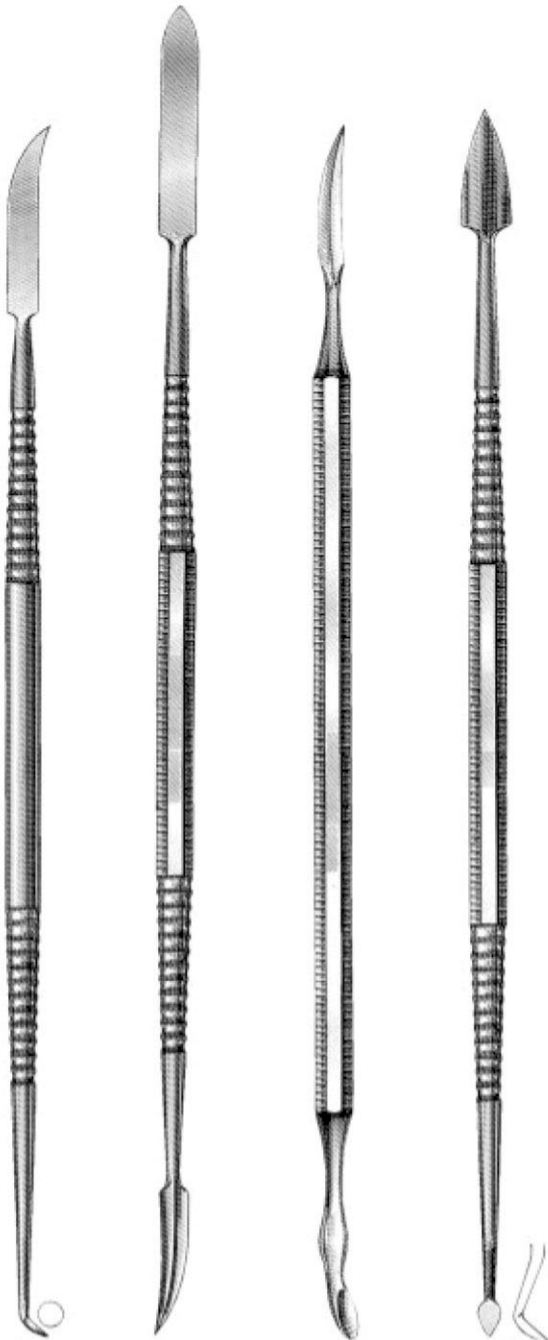

2136  
LECRON  
Inlay

2137  
REEVES

2138  
VEHD  
Wax

2139  
ROACH  
Wax

### WAX SPATULAS

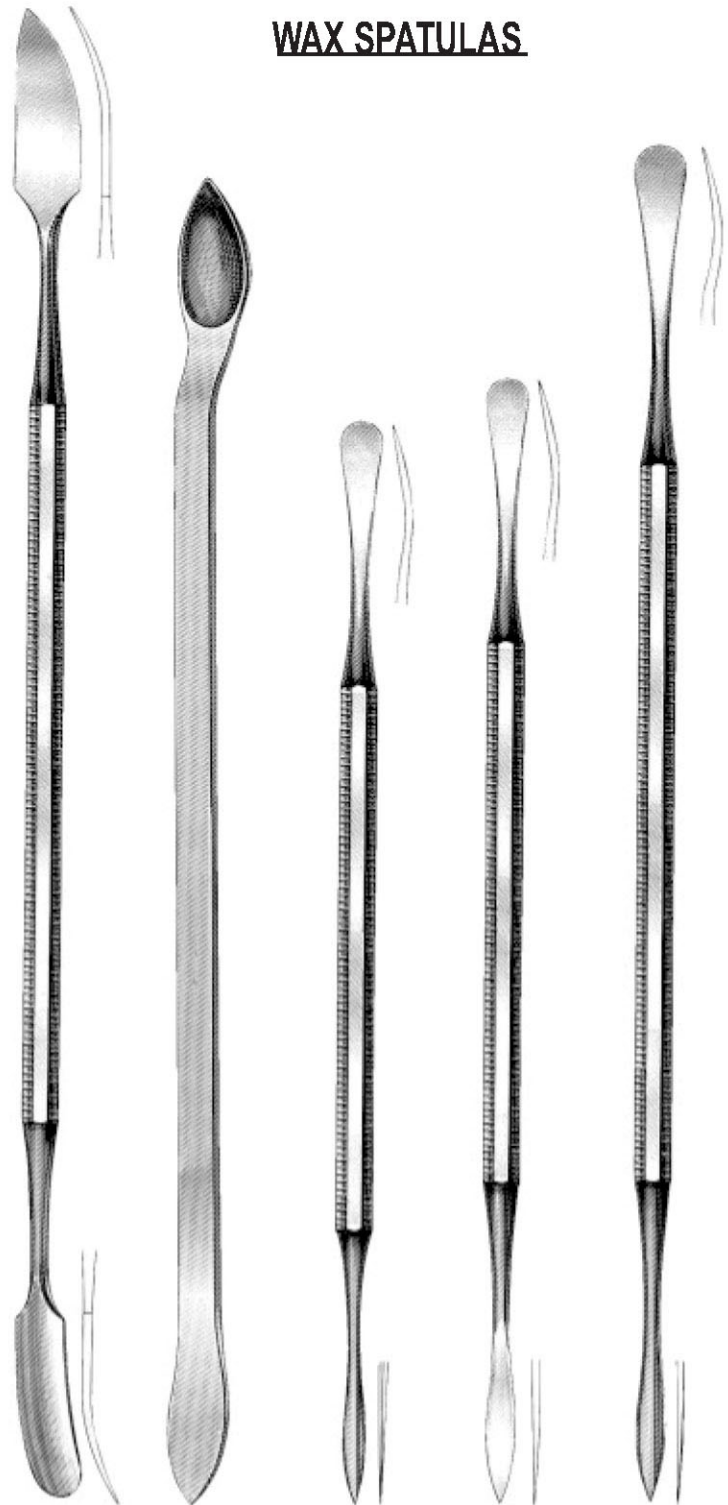

2140  
W-31

2141  
W-5

2142  
W-7

2143  
W-7A

2144  
W-7G



## Cement Spatulas

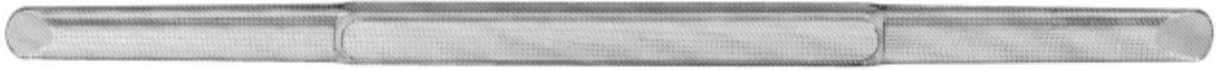

2145  
AGATHE



2146  
C-7



2147  
C-5

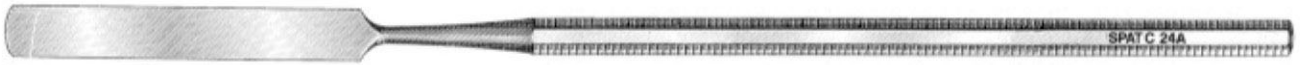

2148  
C-313



2149  
C-24A Rigid



2150  
C-24 Flexible



2151  
C-24 Flexible



2152  
24



2153  
A6



2154  
7 Wax



2156  
All Metal Spatulas with High Polish  
Stainless Steel Blade



2157  
31



Spatulas



**2158**  
Fig. 1  
18.5 cm

**2159**  
Fig. 2  
18 cm

**2160**  
Fig. 3  
18.5 cm

**2161**  
Fig. 4  
19.5 cm

**2162**  
Fig. 5  
21.5 cm

**2163**  
Fig. 6  
20.5 cm



# Spatulas



**2164**  
Fig. 7  
19.5 cm



**2165**  
Fig. 8  
20 cm

**2166**  
Fig. 9  
22.5 cm





# Files, Hoes & Knives

## FILES

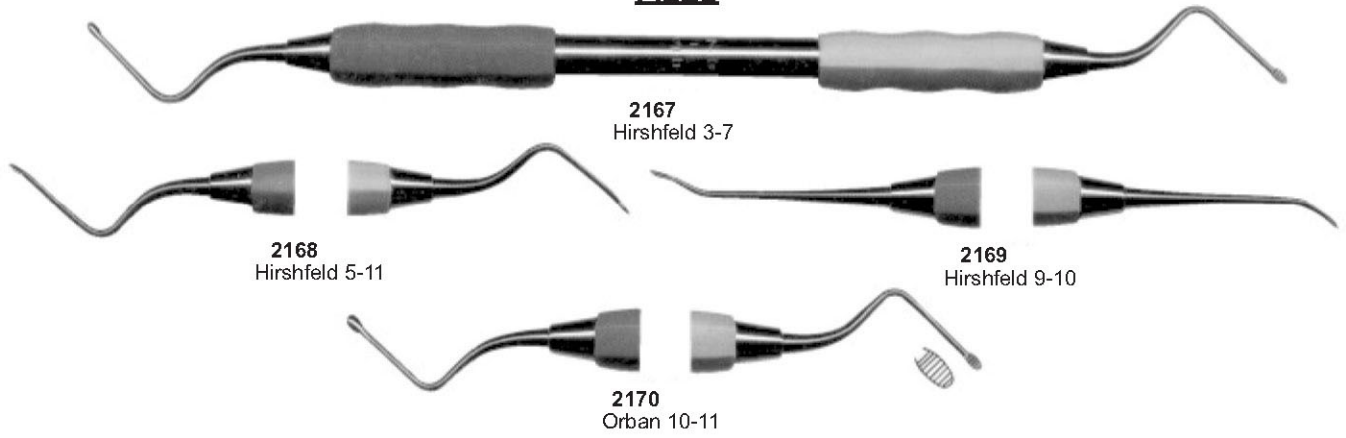

## HOSE

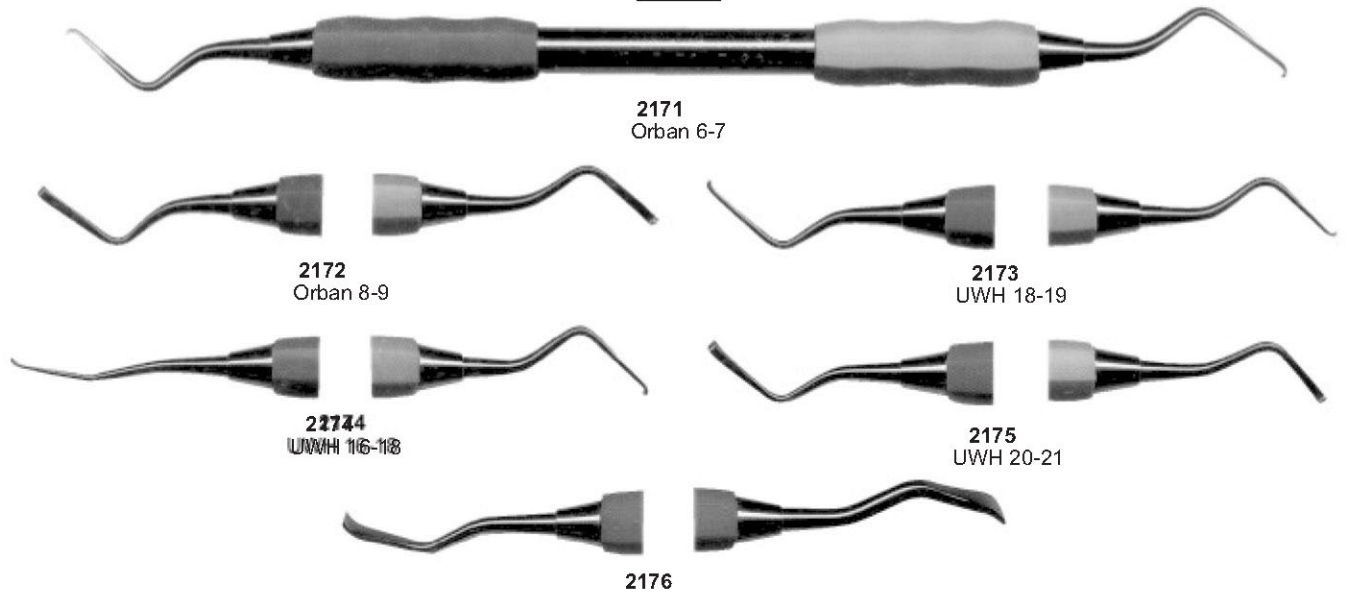

## KNIVES

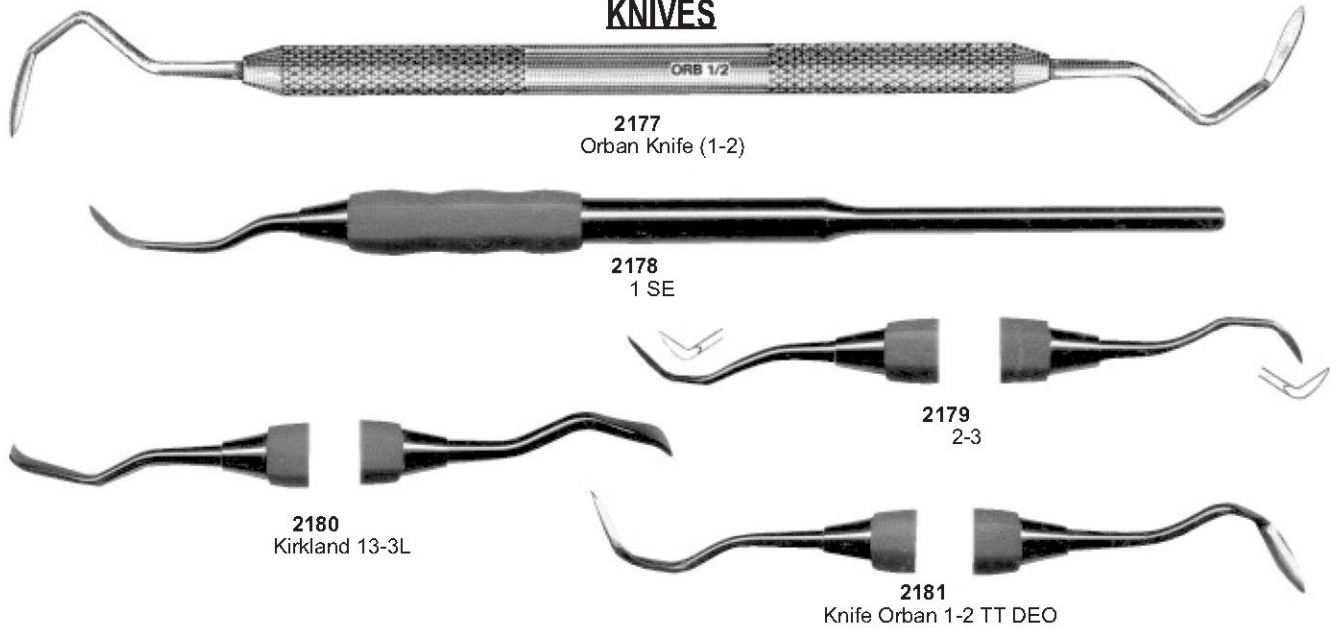



Wax Knives



**2182**  
Fehnenstock  
Fig. 1  
12,5cm

**2183**  
Fehnenstock  
Fig. 2  
17cm

**2184**  
Lessmann  
Fig. 1  
17cm

**2185**  
Lessmann  
Fig. 2  
17cm

**2186**  
Con scodellino  
Fig. 2  
17cm

**2187**  
Con scodellino  
Fig. 2  
17cm

**2188**  
Ermert

**2189**  
Ermert



## Wax Knives & Plaster Knives



**2190**  
18 cm  
7 1/8"



**2191**  
18 cm  
7 1/8"



**2192**  
17 cm  
6 3/4"  
Grilman



**2193**  
17 cm  
6 3/4"  
Medioon



**2194**  
Fig. 1  
17 cm



**2195**  
22 cm  
8 3/4"



**2196**  
22 cm  
8 3/4"



**2197**  
Griftman  
18 cm  
7 1/8"



**2198**  
Fig. 3  
16 cm



**2199**  
Fig. 4  
16 cm



# Crane-Kaplan, Chisels

## CRANE-KAPLAN



**2200**  
CK1  
Pocket Marker

**2201**  
CK2  
Pocket Marker



**2202**  
Knife



**2203**  
Dissector



**2204**  
Scsler

## OCHSENBEIN



**2205**  
Ochsenbein  
Fig.1



**2206**  
Ochsenbein  
Fig.2



**2207**  
Ochsenbein  
Fig.4

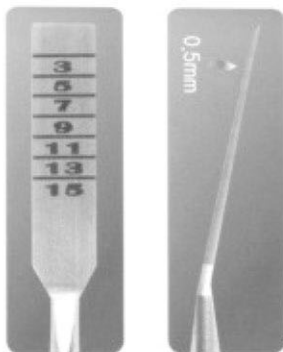

Split Chisel Set



**2208**  
Split Chisel  
6 mm Curved



**2209**  
Split Chisel  
6 mm Curved



**2210**  
Split Chisel  
4 mm Curved

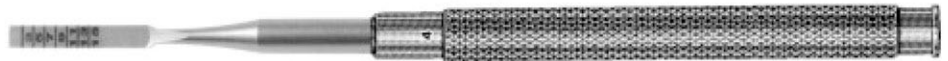

**2211**  
Split Chisel  
4 mm Curved



# Bone Curettes

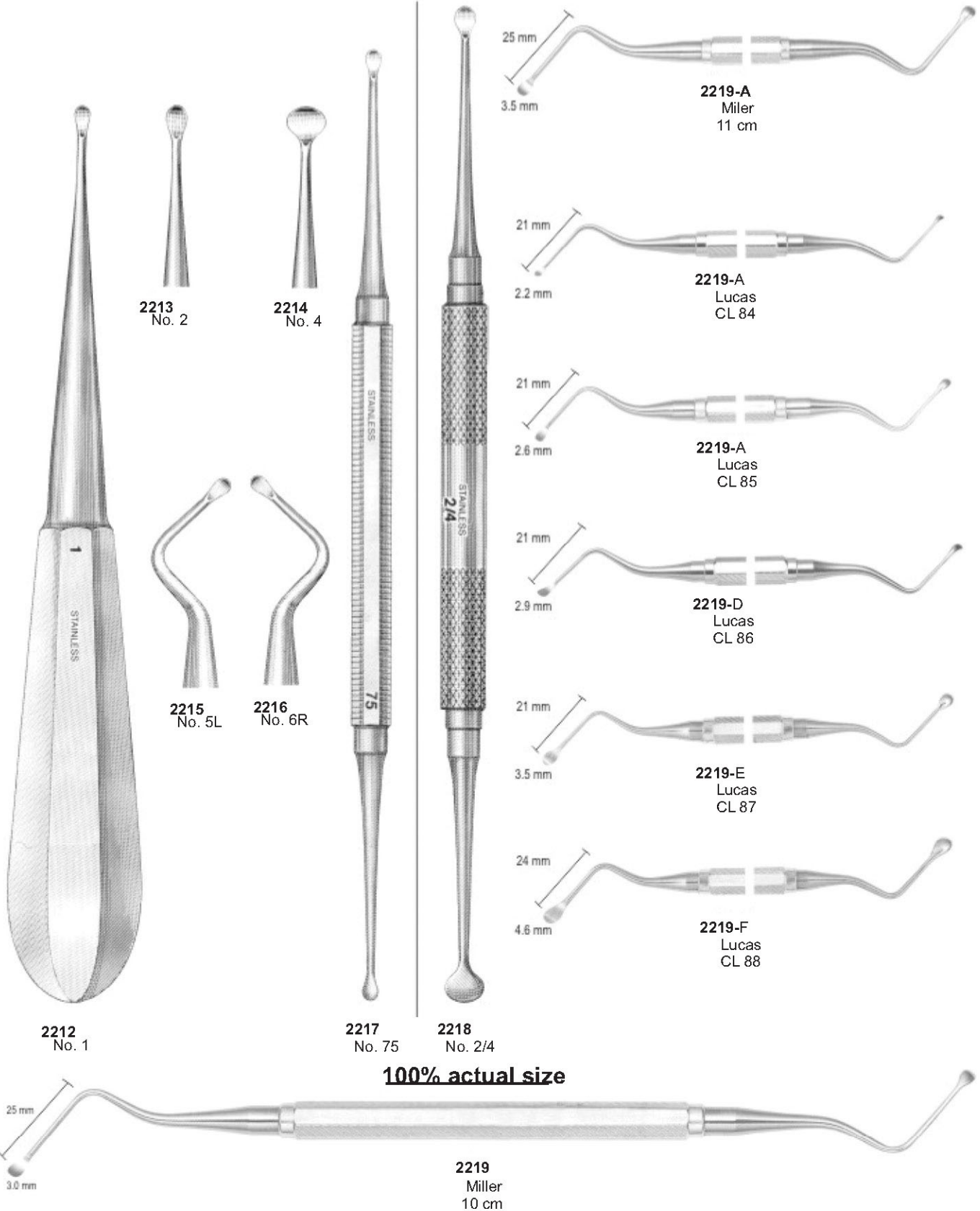



# Bone Files

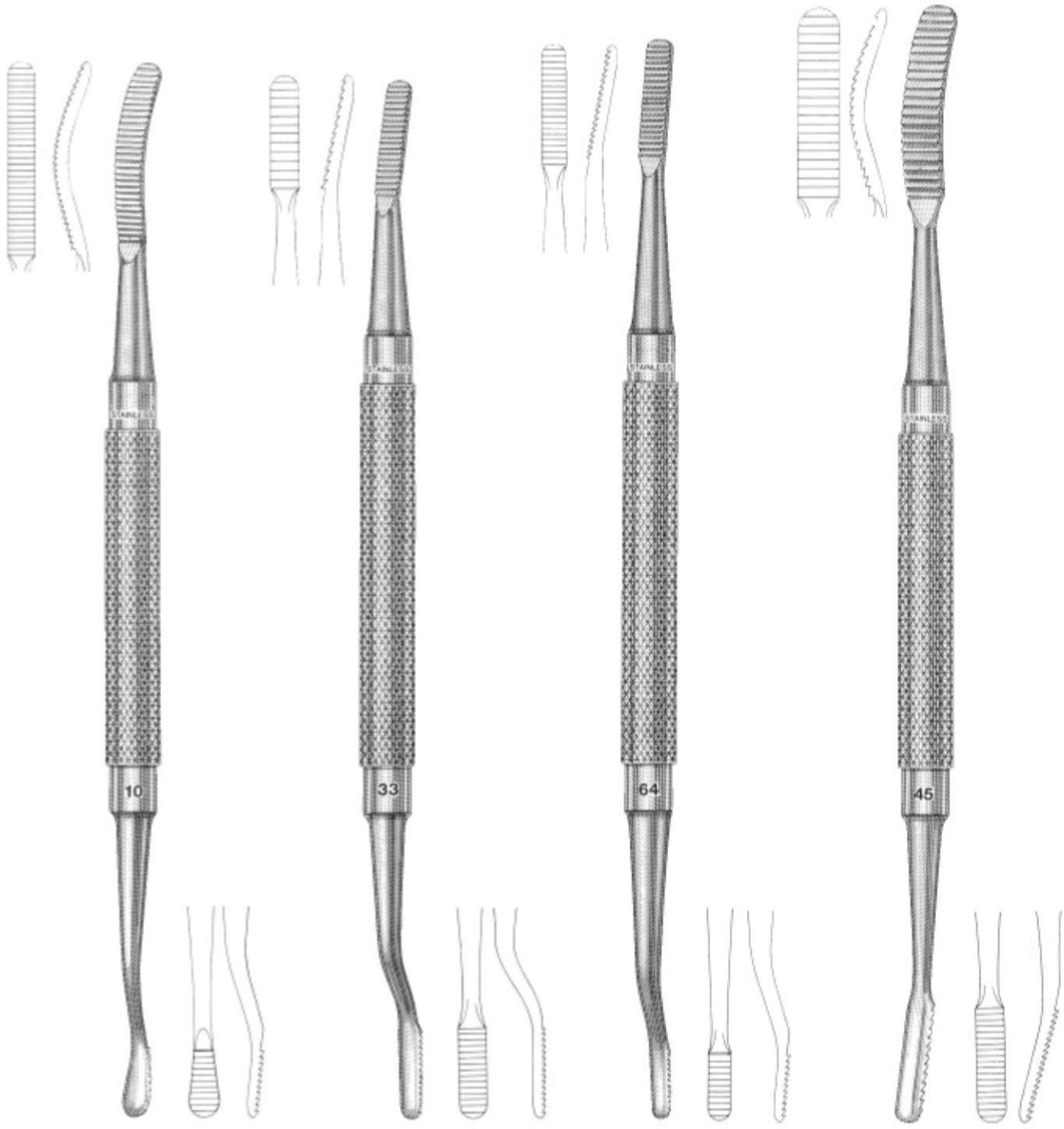

**2220**  
No.10

**2221**  
No.33

**2222**  
Moller  
No.33

**2223**  
Moller  
No.64



Bone Files

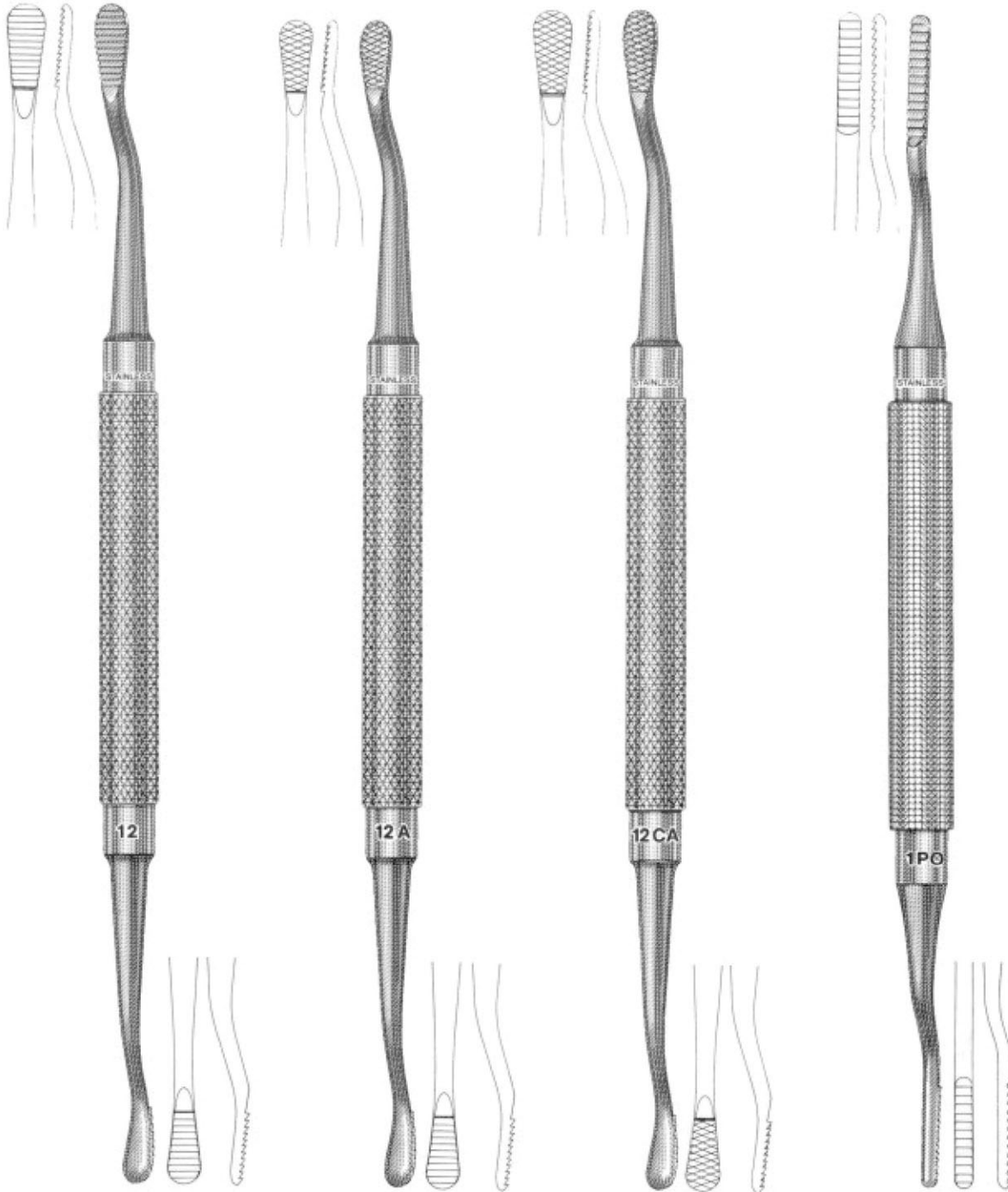

2224  
HOWARD  
No. 12

2225  
HOWARD  
No. 12A

2226  
HOWARD  
No. 12CA

2227  
POLOKOFF  
No. 1



# Bone Chisels

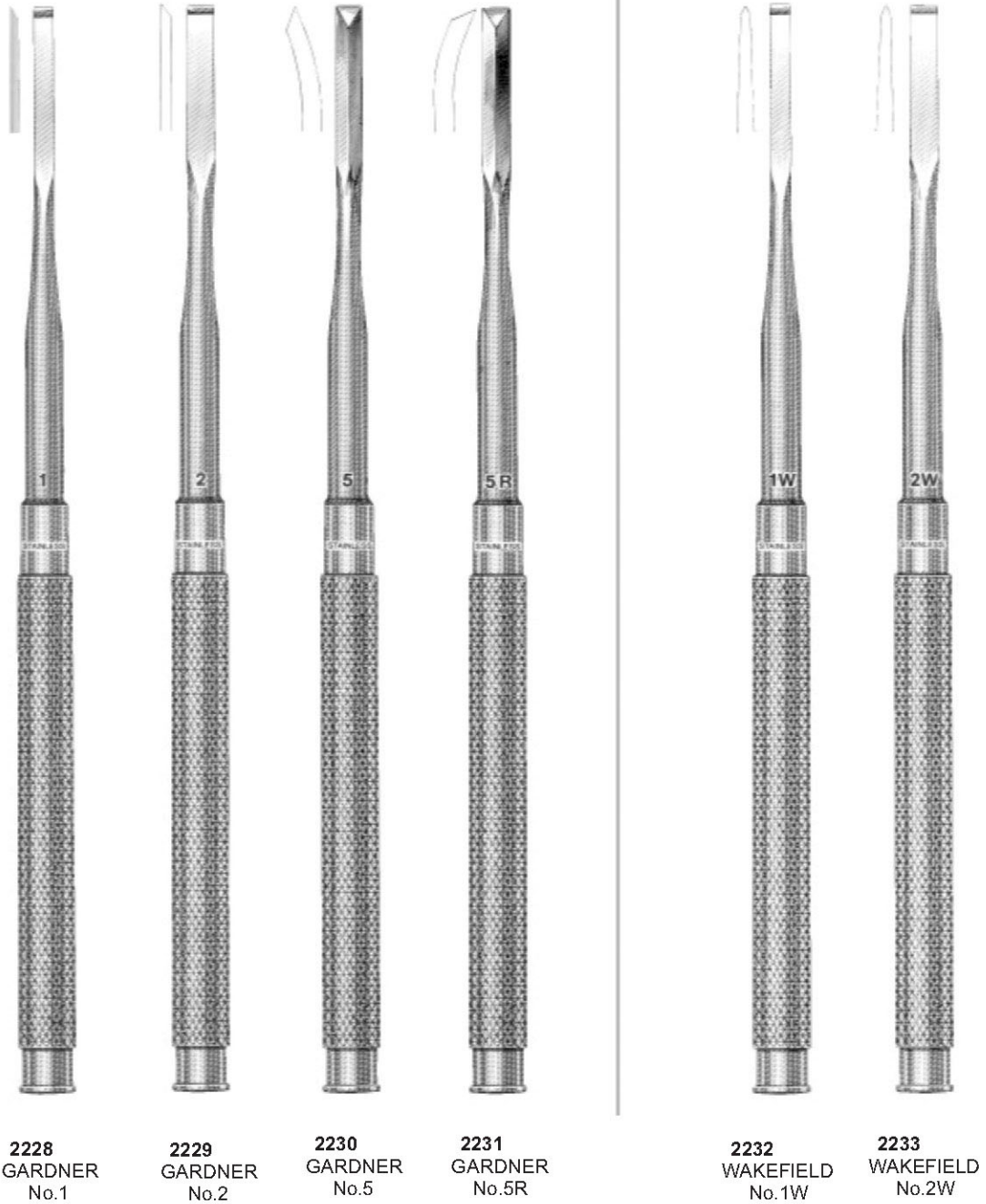





Bone Chisels, Bone Mallets

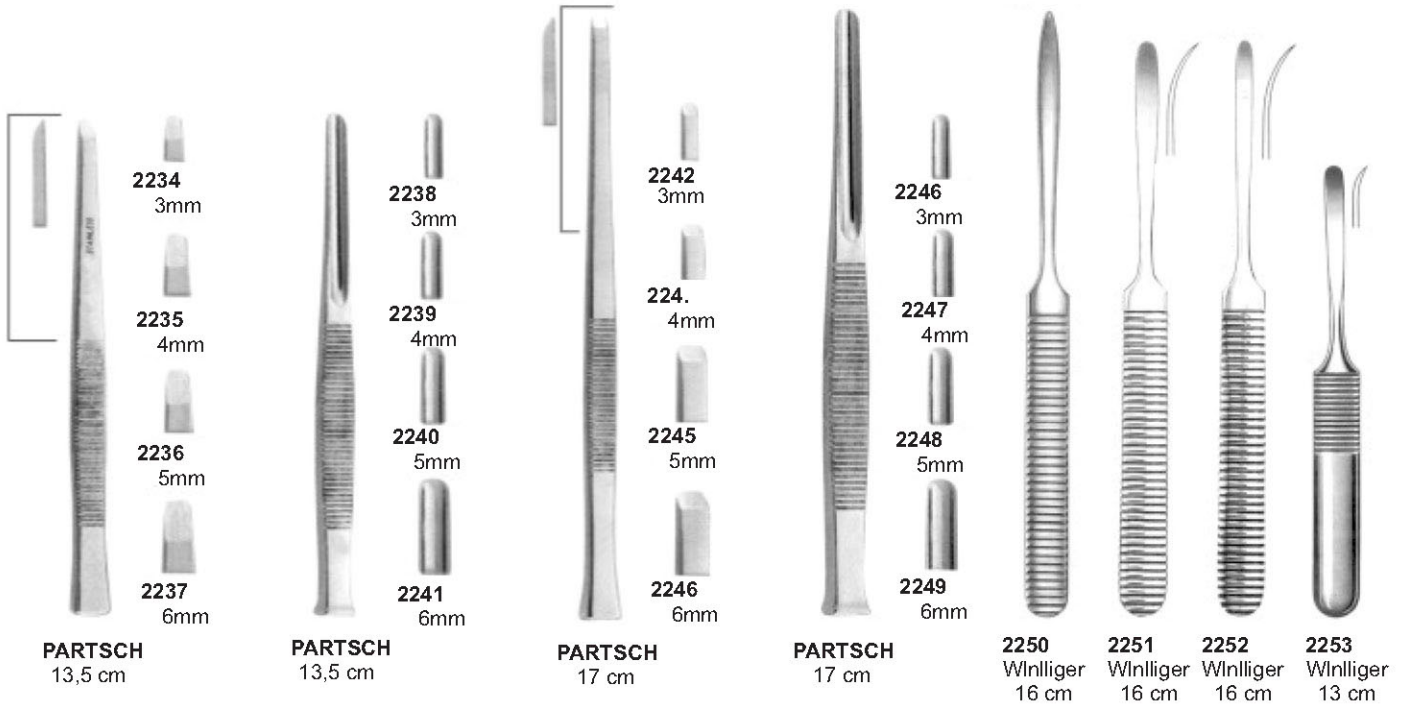

**PARTSCH**  
13,5 cm

**PARTSCH**  
13,5 cm

**PARTSCH**  
17 cm

**PARTSCH**  
17 cm

**2250**  
Winlliger  
16 cm

**2251**  
Winlliger  
16 cm

**2252**  
Winlliger  
16 cm

**2253**  
Winlliger  
13 cm

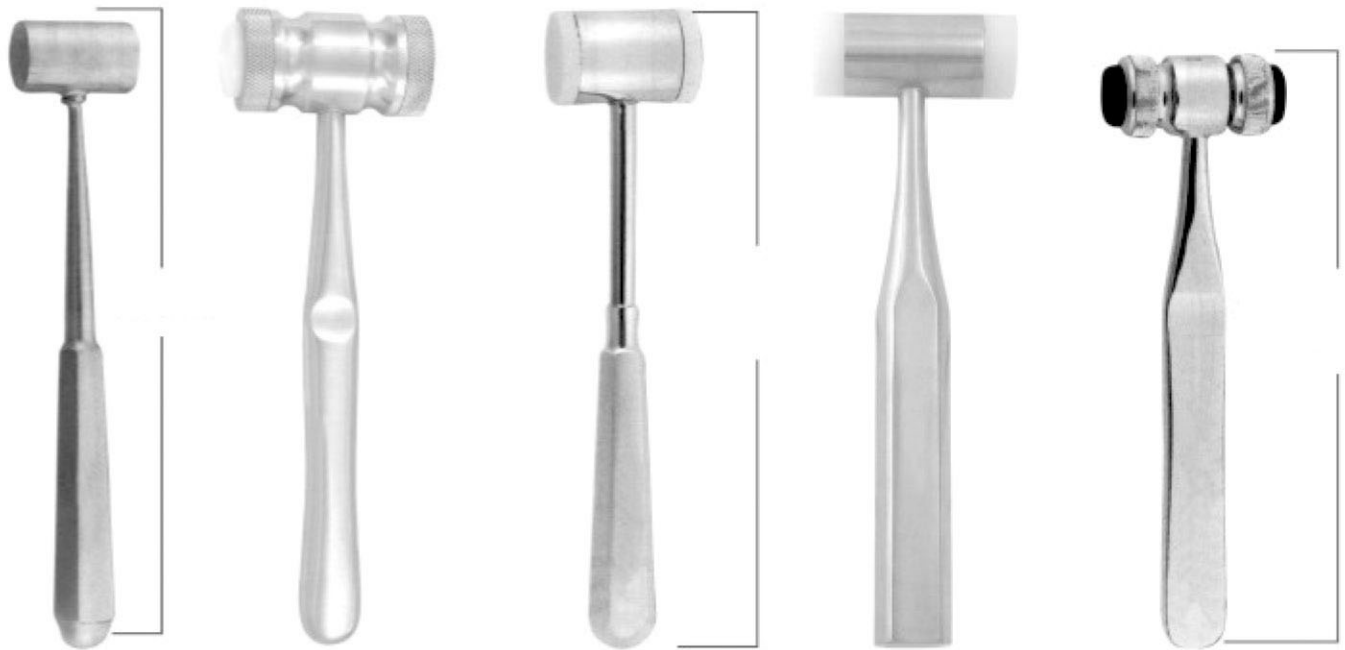

**2254**  
**PARTSCH**  
19 cm

**2255**  
Non Autoclavable  
Plastic tips,  
17 cm

**2256**  
**MEAD**  
19,5 cm

**2257**  
Autoclavable  
Plastic tips,  
18.5 cm

**2258**  
**MEAD**  
17 cm



Crown Removers

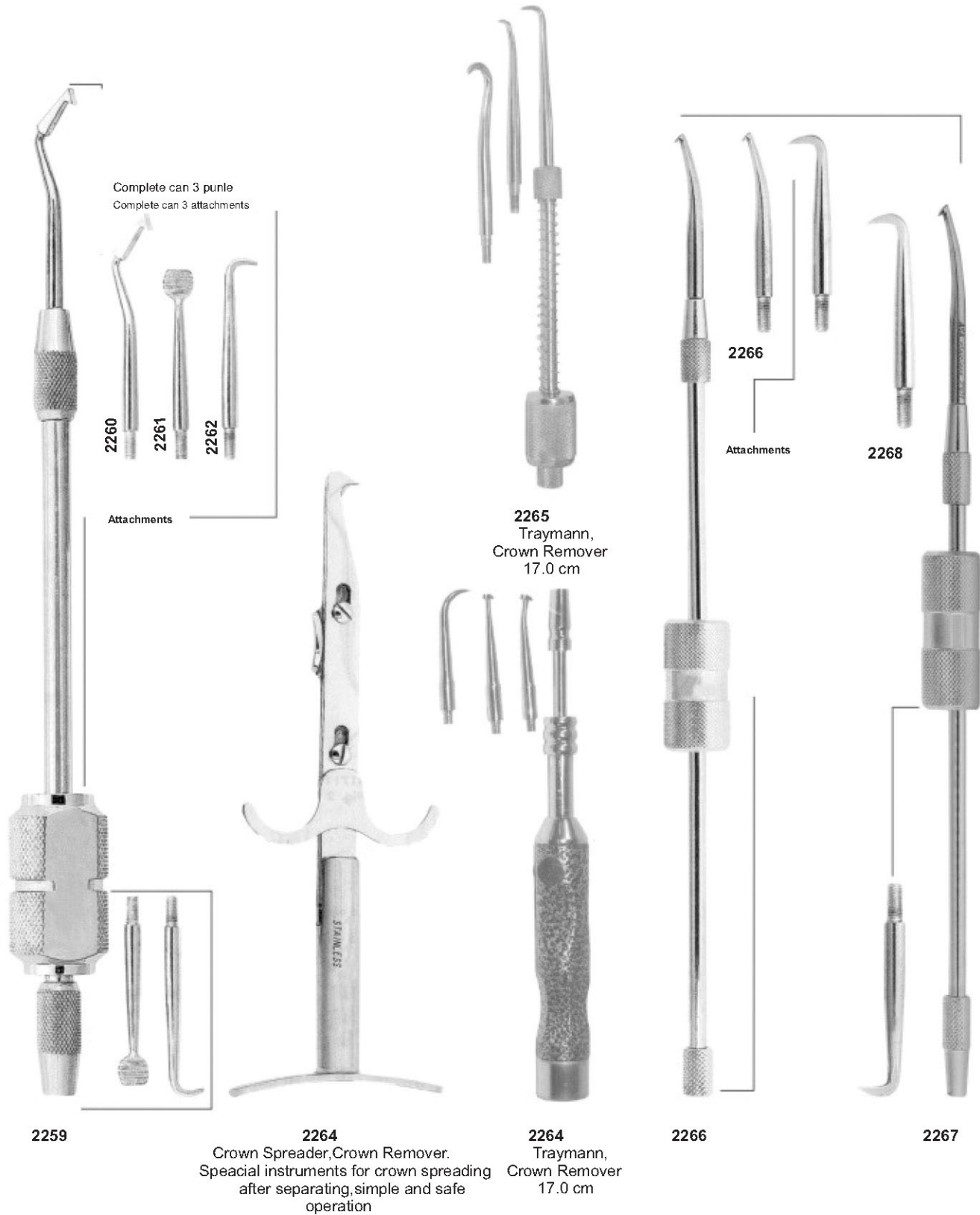



Crown Instruments



Fig.3  
2269  
Crown Remover

Fig.1  
Fig.2  
Fig.3  
2270  
Crown Remover

2271  
single loop  
with adapter

2272  
2273  
KEY/9 ADAPTER/8  
2274  
Crown & Bridge Holding Forceps  
with Support Ring



2275  
WYMAN  
Crown Gripper, CARB-N-SERT

2276  
Crown opener

2277  
Mershohn  
14.5 cm/53/4

2278  
Universal  
Hollow Handle

2279 Fig.2  
2280 Fig.3  
2281 Fig.4



Crown Instruments



**2282**  
Plaster SHERA  
210 mm

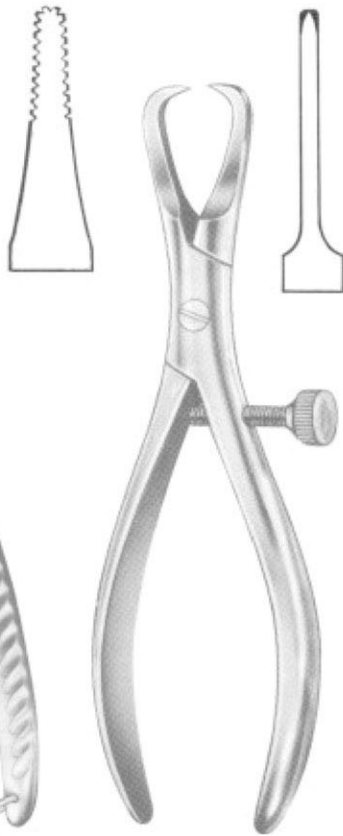

**2283**  
Crown Removing Plier  
210 mm



**2284**  
MONTFORT  
210 mm



**2285**  
BOHM  
16 cm



**2286**  
Telescope Crown  
Plier, Diamod coated  
13.0 cm



**2287**  
Telescope Crown  
Plier, Diamod coated  
13.0 cm



**2288**  
Telescope Crown Plier  
13.0 cm gerieften Mual  
15.0 cm gerieften Mual  
13.0 cm gelatts Mual  
15.0 cm gelatts Mual



**2288**  
Telescope Crown  
Plier, Fine  
15.0 cm



# Implants Instruments



**2290**  
1P  
150 mm



1P  
150 mm



2P  
150 mm

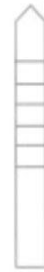

3P  
150 mm

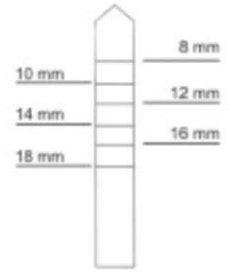

4P  
150 mm



1T  
150 mm



2T  
150 mm



3T  
150 mm



**2291**  
Fig. 1  
155 mm



1  
155 mm



2  
155 mm



3  
155 mm



4  
155 mm



5  
155 mm



6  
155 mm



Implants Instruments



**2292**  
Fig. 1B  
165 mm



2 mm  
1B



3 mm  
2B

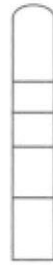

3.3 mm  
3B

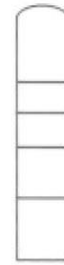

4 mm  
4B



5 mm  
5B

6 mm  
8 mm  
11 mm  
15 mm



2 mm  
1BCC



3 mm  
2BCC



3.3 mm  
3BCC

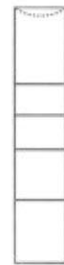

1 mm  
1BCC



5 mm  
5BCC

6 mm  
8 mm  
11 mm  
15 mm



**2293**  
Fig. 1  
155 mm



2 mm  
1RRT



3 mm  
1RRT



3.3 mm  
3RRT

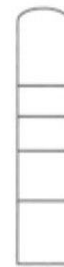

4 mm  
4RRT



5 mm  
5RRT

6 mm  
8 mm  
11 mm  
15 mm



2 mm  
1RRC

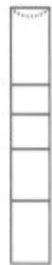

2 mm  
1RRC

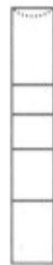

3.3 mm  
3RRC

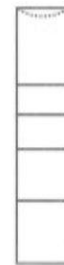

4 mm  
4RRC



5 mm  
5RRC

6 mm  
8 mm  
11 mm  
15 mm



Implants Instruments

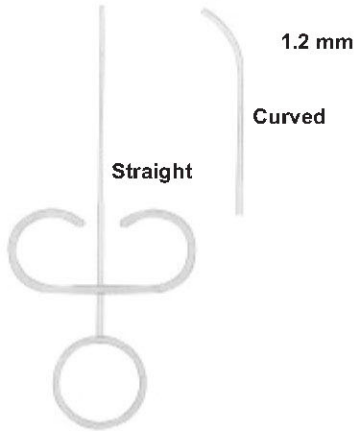

**2294**  
1.2 mm  
130 mm

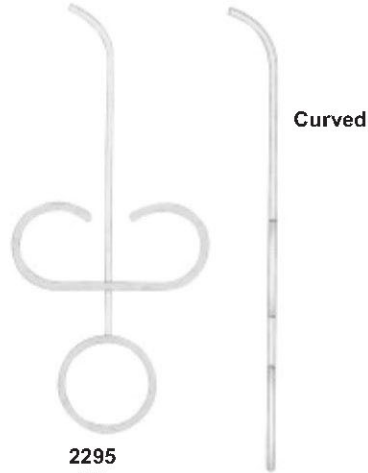

**2295**  
1.8 mm  
130 mm



Bone Injectors



**2296**  
2.5 mm  
150 mm



**2297**  
4.4 mm  
150 mm



**2298**  
7 mm  
150 mm



**2299**  
2.5 mm  
150 mm



**2300**  
4.4 mm  
150 mm



Bone Well

**2301**  
35 mm  
h 35 mm



**2302**  
Grinder for autogenous

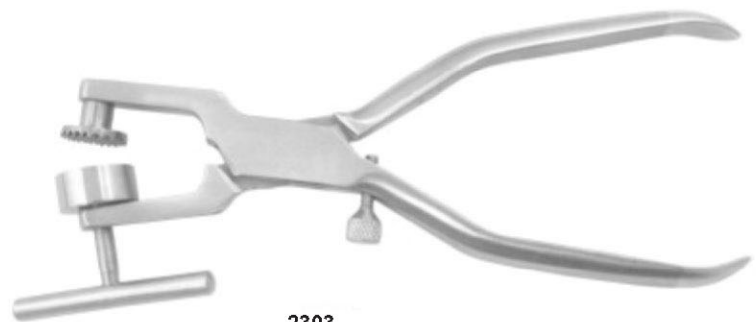

**2303**  
Bone Mil Forceps  
17.0 cm



## Suction Tubes, Bone Pluggers & Roungeures

### Suction Tubes

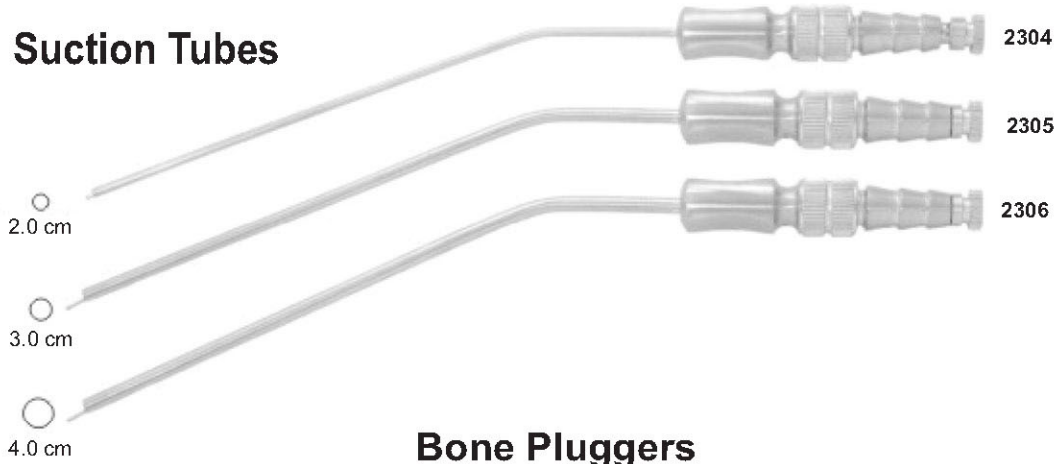

### Bone Pluggers



### Kerrison Roungeures







# Implants Instruments

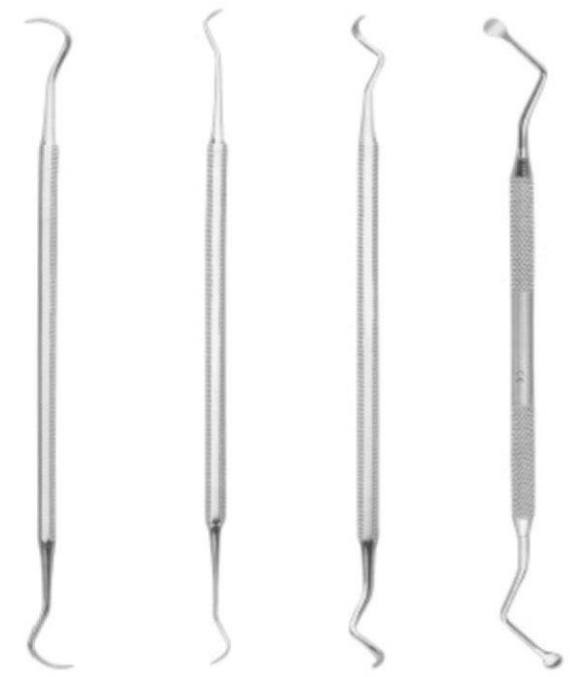

**2319** Fig.1 170 mm  
**2320** Fig.2 175 mm  
**2321** Fig.3 170 mm  
**2322** Fig.88 170 mm



**2323** Fig.1 3-4 mm  
**2324** Fig.2 6-8 mm

**Bone Compactors.**

**TERPINE burs with depth marking**

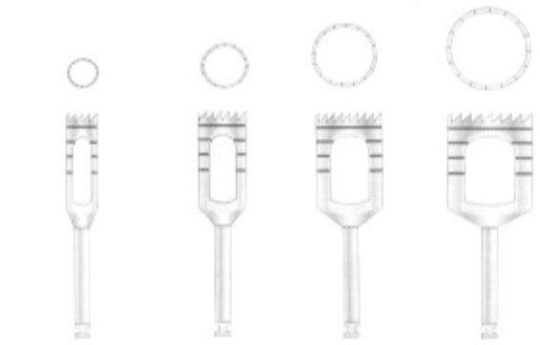

**2325** Ext. 3.5 mm Int. 3 mm  
**2326** Ext. 6 mm Int. 35 mm  
**2327** Ext. 8.5 mm Int. 7.55 mm  
**2328** Ext. 11 mm Int. 10 mm

**Sinus Lift instruments**

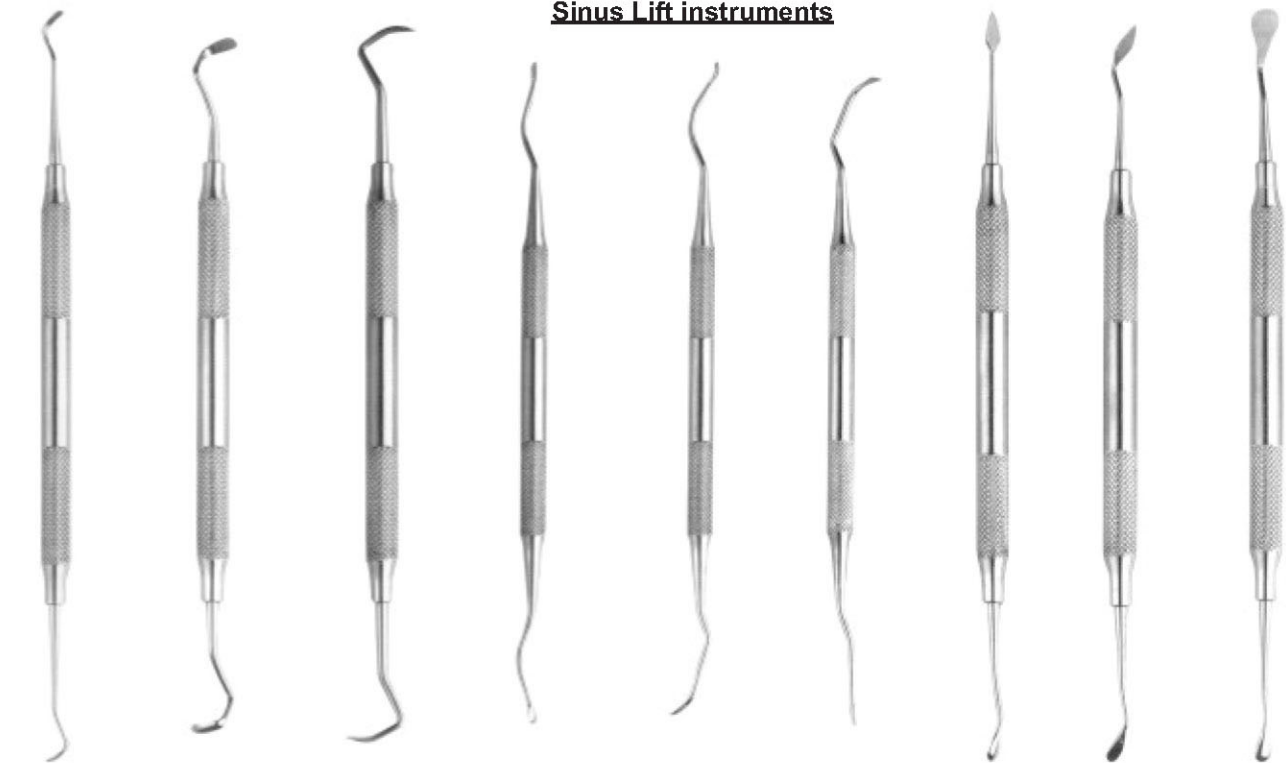

**2329** Fig. 1  
**2330** Fig. 2  
**2331** Fig. 3  
**2332** Fig. 4  
**2333** Fig. 5  
**2334** Fig. 6  
**2335** Fig. 7  
**2336** Fig. 8  
**2337** Fig. 9



## Suction Tubes

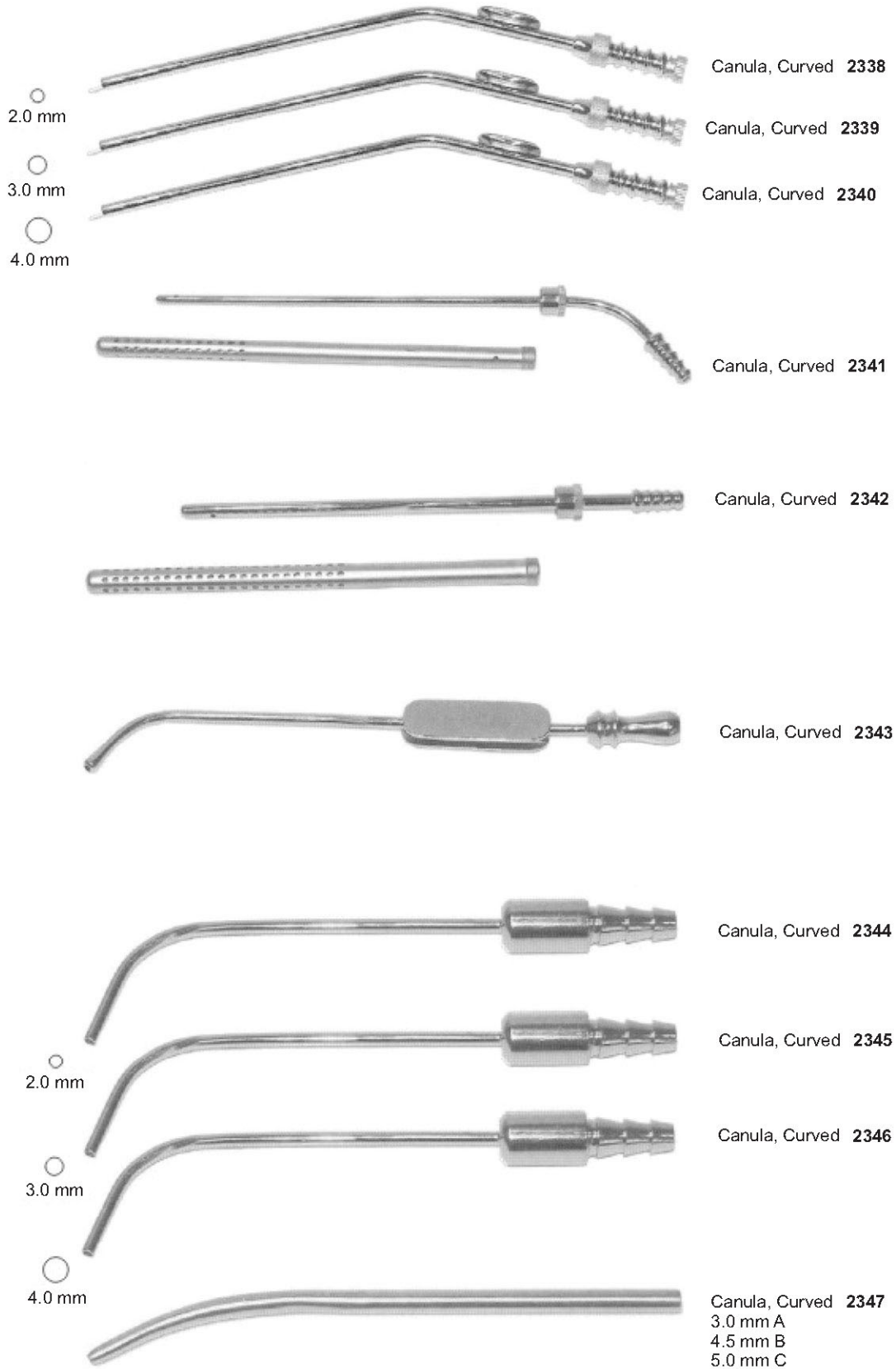



Measuring Instruments



**2348**  
BOLEY Gauge



**2349**  
ZURICHER  
130 mm



**2350**  
VERNIER  
12 cm



**2351**  
VERNIER



**2352**  
VERNIER Gauge



**2353**  
VERNIER Gauge



**2355**  
Finger Ruler



**2354**  
LWANSON  
Crown Gauge

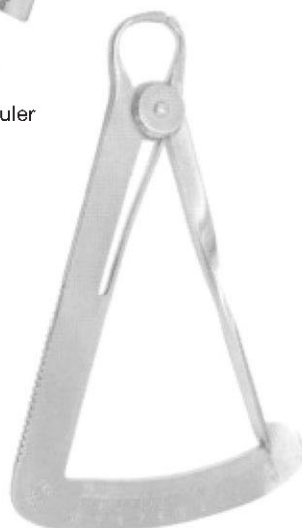

**2356**  
LWANSON  
Crown Gauge



**2357**  
Sliding Gauge  
10 cm



**2358**  
Spring Bow Divider  
6" Radii



**2359**  
VERNIER  
Gauge

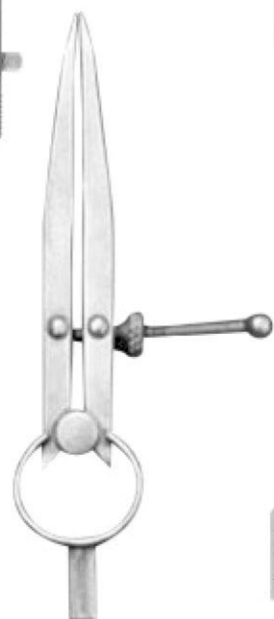

**2360**  
ALBEE



**2361**  
Height Gauge  
Wick Type



Bone Gauge & Measuring Instruments



2362  
Bone Gauge



2363  
Bone Caliper  
15 cm



2364  
Castroviejo



2365 B  
Straight



2365 A  
Castroviejo  
Curved



2366 C  
Castroviejo  
Straight

2366 D  
Curved



2367  
Gauge

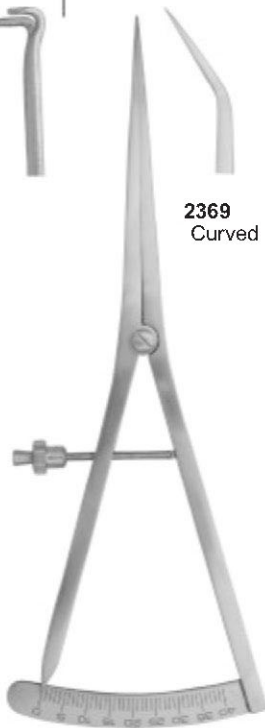

2368  
Castroviejo  
Straight



2369  
Curved



2370A

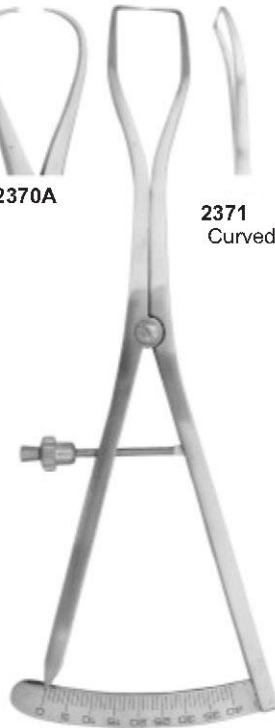

2370  
Castroviejo  
Straight



2371  
Curved



2373  
Boone-Gauge



2372  
Castroviejo



2374  
Curved



2375  
Straight



2376  
Boone-Gauge. Ant/Post





## Amalgam Guns & Carriers



**2377** Medium-Larde 20 cm  
**2378** Medium-Larde 20 cm  
**2379** Large-Jambo 20 cm  
**2380** Jambo-Jambo 20 cm  
**2381** Regular-Jambo Silicon Grip 20 cm  
**2382** Medium 15.5 cm  
**2383** Large 15.5 cm  
**2384** Jumbo 15.5 cm



**2385** 145 cm  
**2386** 130 cm  
 2mm  
**2387** Straight 15 cm  
 2mm  
**2388** 15 cm  
**2389** 15 cm 90  
**2390** Amalgam Well Non Skid Base 3.5 mm



## Retainers, Bands, Strip Holder Clips, Napkin Holder

### Retainers

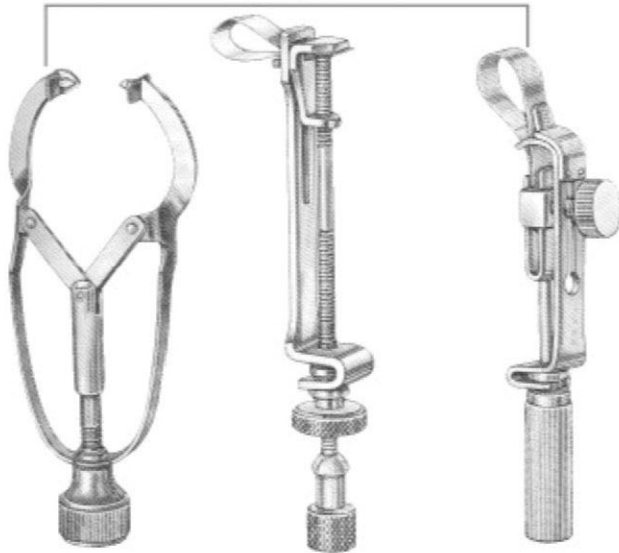

2391  
No.1

2392  
No.8

2393  
No.9

### "Tofflemire" Type Retainers

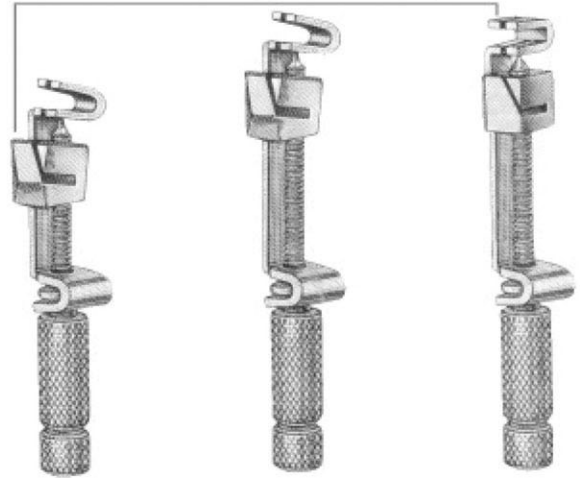

2394  
JUNIOR-CA

2395  
SENIOR-CA

2396  
UNIVERSAL

### Tofflemire Bands

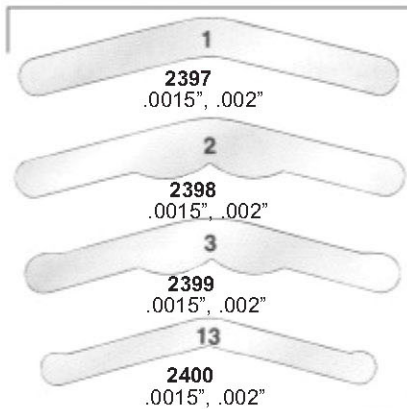

2397  
.0015", .002"

2398  
.0015", .002"

2399  
.0015", .002"

2400  
.0015", .002"

2401  
X-Ray Holder  
Small

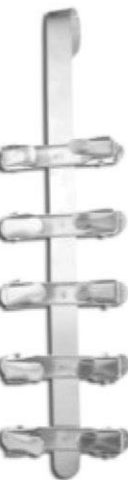

Set of 10  
2402  
Film Hanger

### Napkin Holder



2403  
BALL CHAIN

2404  
NON-CHILL  
Clear Plastic

### Strip Holder

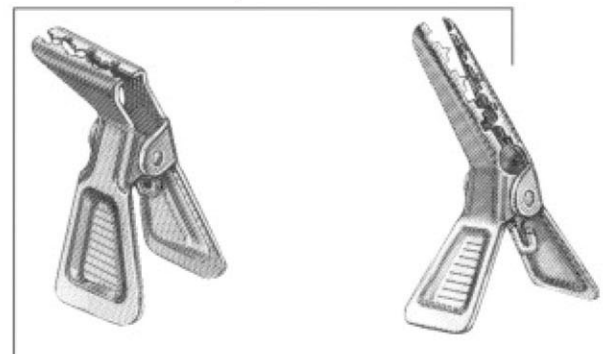

2408  
Strip Holder Clip  
90

2409  
Strip Holder Clip  
45

2405  
Finger Protector  
Small

2406  
Medium

2407  
Large



Rubber Dam Instruments



**2410**  
IRORY  
Leight weight, 170 mm



**2411**  
BREWER  
175 mm



**2412**  
BREWER  
175 mm



**2413**  
WHITE  
175 mm



**2414**  
IVORY  
175 mm



**2415**  
AINSWORTH  
Rubber Dam Punch  
17 mm



**2416**  
AINSWORTH  
Ainsworth  
Rubber Dam Punch  
17 mm



**2417**  
AINSWORTH  
Rubber Dam Punch  
17 mm



**2421**  
MILLER  
Articulating  
Forceps  
15 cm



**2422**  
MILLER  
Articulating  
Forceps  
15 cm

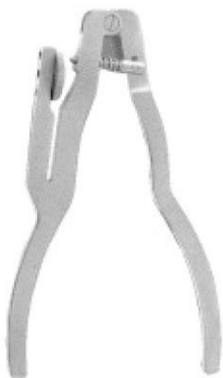

**2418**  
"IV" Type  
Rubber Dam Punch  
160 mm



**2419**  
Plastic Rubber Dam  
Frame 242

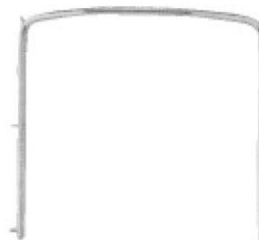

**2420**  
Rubber Dam Holder  
Stainless Steel Pins



# Rubber Dam Clamps

## LOWER MOLARS



2423  
76D-W3



2424  
76D-3

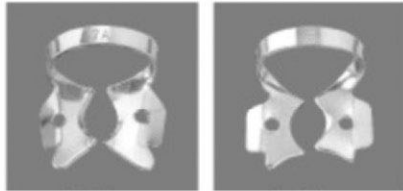

2429  
76D-7A



2430  
76D-7



2435  
76D-12A



2436  
76D-13A



2441  
76D-25



2442  
76D-28



2445  
76D-W8A



2446  
76D-8A

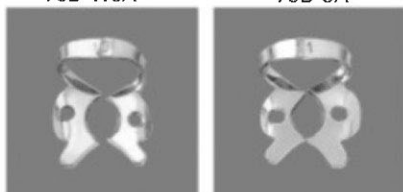

2447  
76D-10



2448  
76D-11



2451  
76D-24



2452  
76D-25

## UPPER MOLARS



2425  
76D-4



2426  
76D-5



2437  
76D-8



2432  
76D-26N



2437  
76D-30



2438  
76D-31



2443  
76D-201



2444  
205

## MOLARS



2449  
76D-14



2450  
76D-118



2453  
76D-27



2454  
76D-56



2455  
76D-14A

## PERMOLARS

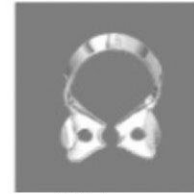

2427  
76D-0



2428  
76D-1



2433  
76D-2A



2434  
76D-2



2439  
76D-27N

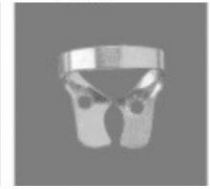

2440  
76D-29

## ANTERIOR



2456  
76D-00



2457  
76D-1A



2458  
76D-9



2459  
76D-212





## Aspirating Syringes

4969/CO



4969/F



4969/CV



**2460**  
ml 1,8  
EU

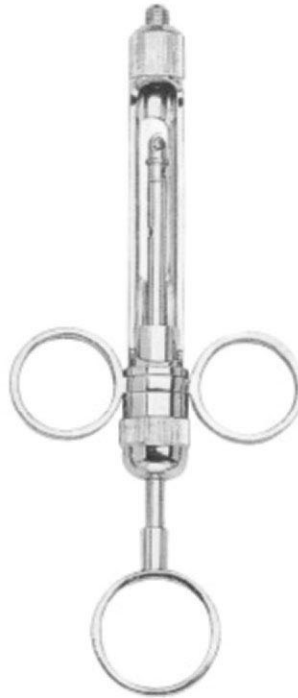

**2461**  
ml 1,8  
EU/AM



**2462**  
ml 1,8  
EU/AM



**2463**  
Fig.1  
ml 1,8  
EU



**2464**  
Fig.1  
ml 1,8  
EU



**2466**  
SS INOX  
All inox & autoclavable  
black plastic handle  
passive automatic  
aspiration.



**2466**  
Fig.1  
ml 1,8  
EU/Am



**2467**  
Fig.1  
ml 1,8  
EU/Am



**2468**  
Fig.1  
ml 1,8  
EU/Am



**2469**  
ml 1,8  
EU/Am



Syringes

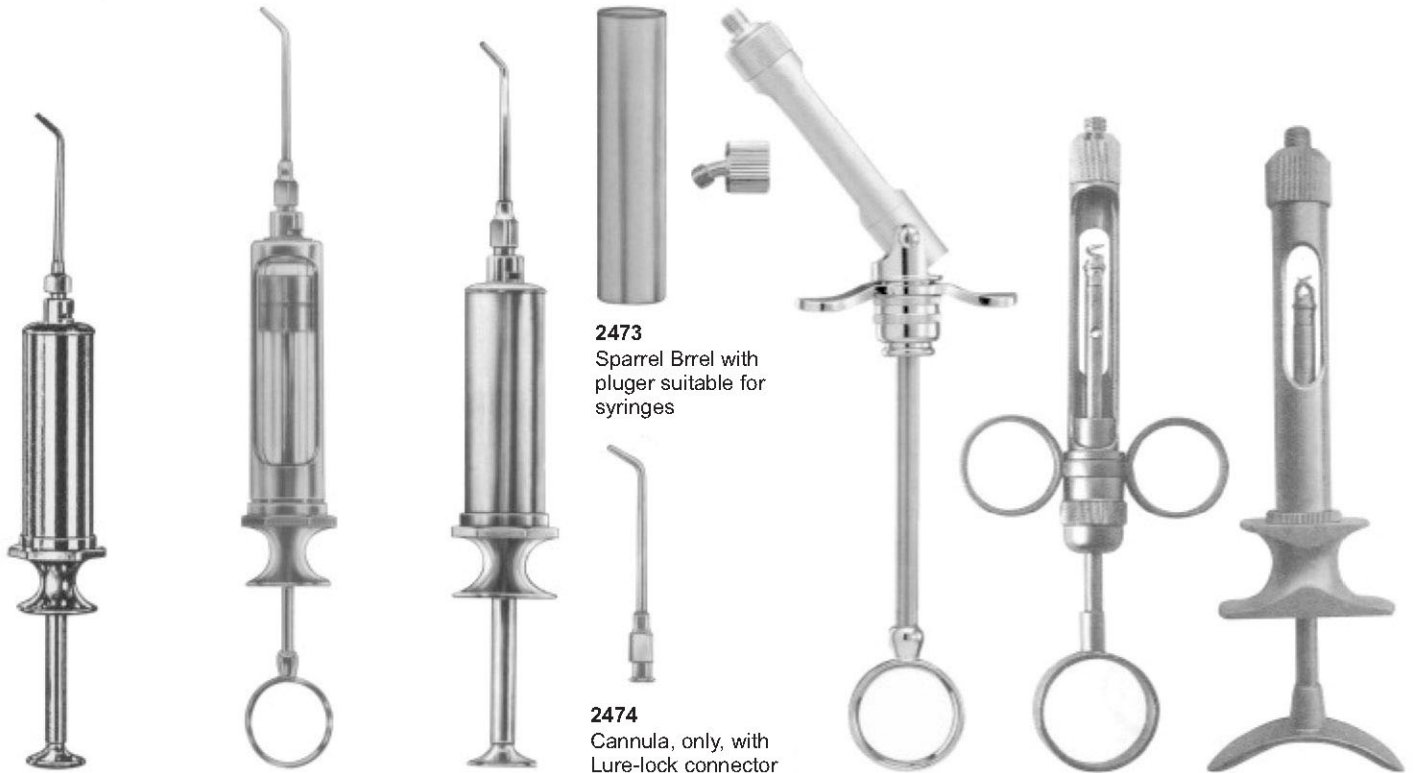

**2470**  
Water Syringe  
complete with  
1 cannula (Lure-Lock)

**2471**  
Water Syringe  
complete with  
1 cannula (Lure-Lock)

**2472**  
Metal Water Syringe  
complete with  
1 cannula (Lure-Lock)

**2473**  
Sparrel Brrel with  
pluger suitable for  
syringes

**2474**  
Cannula, only, with  
Lure-lock connector  
suitable for syringes

**2475**  
Articulating  
Barrel Syringe

**2476**  
MI 1,8

**2477**  
MI 1,8



**2478**

**2479**

**2480**

**2481**  
Fig.1  
MI 1,8 EU

**2485**  
Fig.1  
MI 1,8 EU

**2482**  
Water  
Point

**2483**  
Water  
Point

**2484**  
Water  
Point



Dental Tweezers

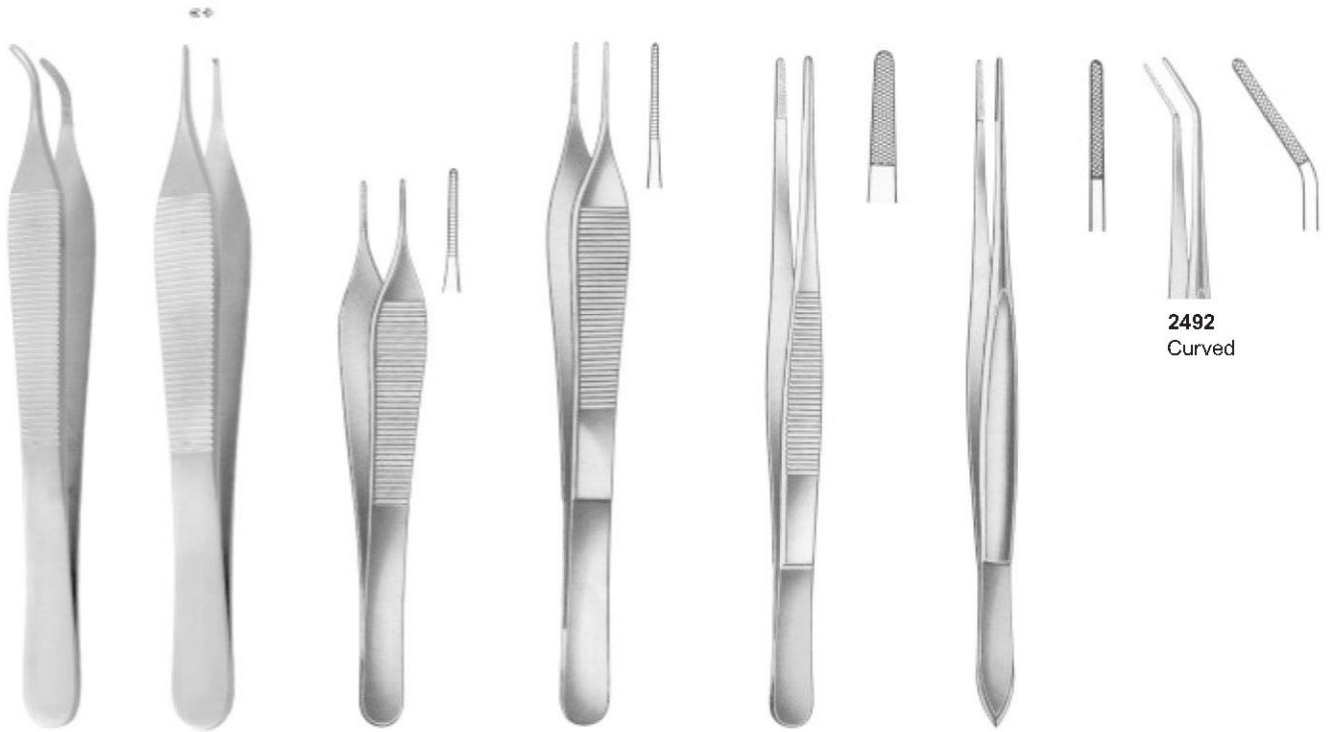

**2486**  
ADSON  
Curved 14 cm

**2487**  
ADSON  
1x2 12 cm

**2488**  
ADSON  
12 cm

**2489**  
MICRO ADSON  
12 cm

**2490**  
STANDARD  
14,18,25 cm

**2491**  
CUSHING  
8 cm

**2492**  
Curved

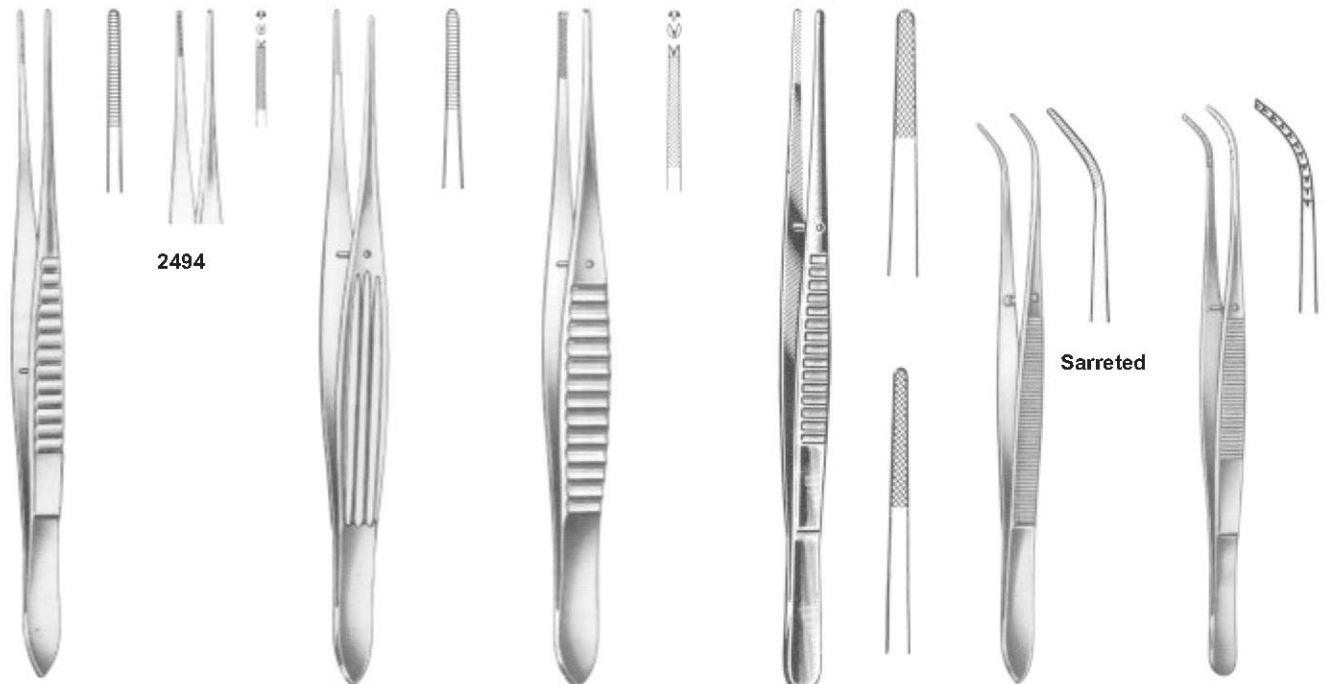

**2494**

**2493**  
SELEST  
15,18,20 cm

**2495**  
MCINODE  
15 cm

**2496**  
SILLIES  
15 cm

**2497**  
WAUGH  
15,20 cm

Sarreted

**2498**  
PERRY  
13 cm

**2499**  
KOPP  
15.5 cm



# Dental Tweezers



**2500**  
COLLEGE  
15 cm



smooth



**2501**  
COLLEGE  
15 cm



Sarreted



**2502**  
COLLEGE  
15 cm

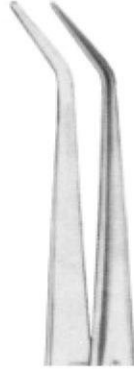

smooth



**2503**  
COLLEGE  
15 cm



Sarreted



**2504**  
COLLEGE  
15 cm



smooth



**2505**  
COLLEGE  
15 cm



Sarreted



**2506**  
COLLEGE  
15 cm



smooth



**2507**  
COLLEGE  
15 cm



Sarreted



## Dental Tweezers



**2508**  
MERIAN  
16 cm



smooth



**2509**  
MERIAN  
16 cm



Sarreted



**2510**  
MERIAN  
16 cm



smooth



**2511**  
MERIAN  
16 cm1



Sarreted



**2512**  
MERIAN  
16 cm



smooth



**2513**  
MERIAN  
16 cm



Sarreted



**2514**  
MERIAN  
16 cm



smooth



**2515**  
MERIAN  
16 cm



Sarreted



## Dental Tweezers

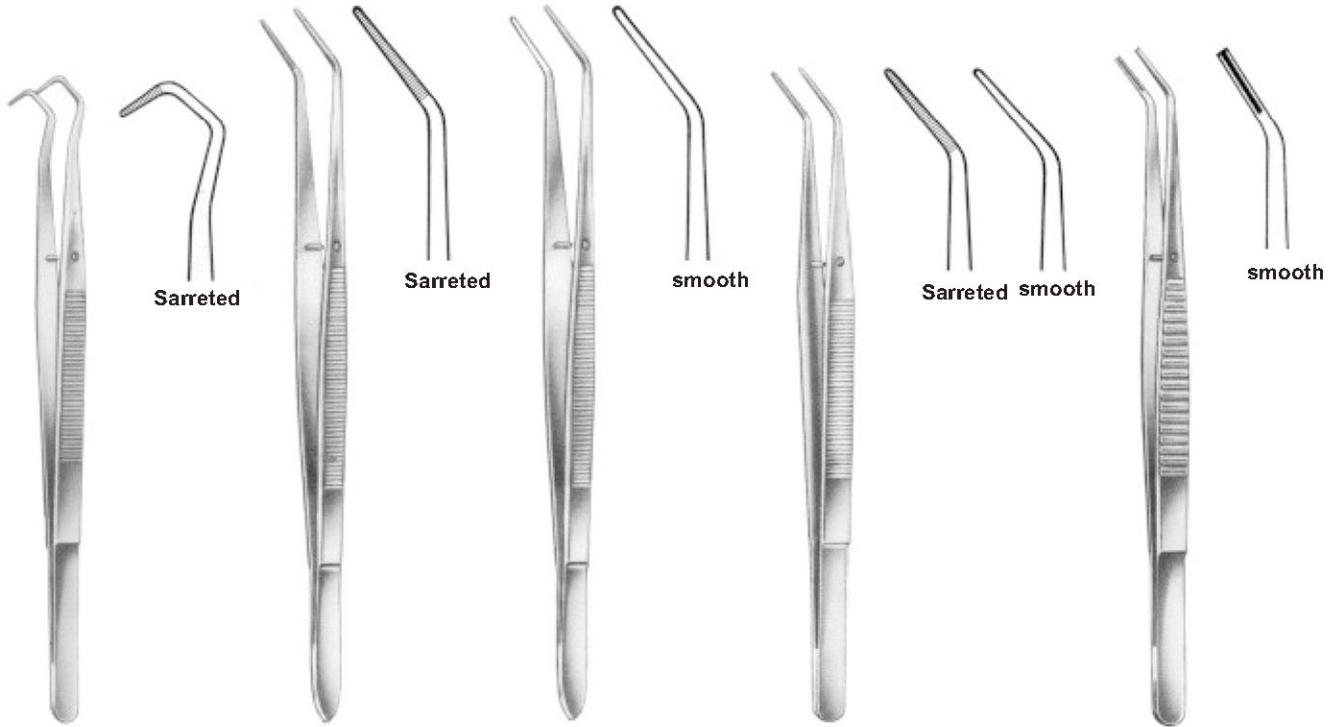

**2516**  
COLLAGE  
14.5 cm, 5 3/4"

**2517**  
FLAGG  
16 cm, 6 1/4"

**2518**  
FLAGG  
16 cm, 6 1/4"

**2519**  
LANDGRAH  
15 cm, 6"

**2520**  
15,5 CM, 6 1/8"

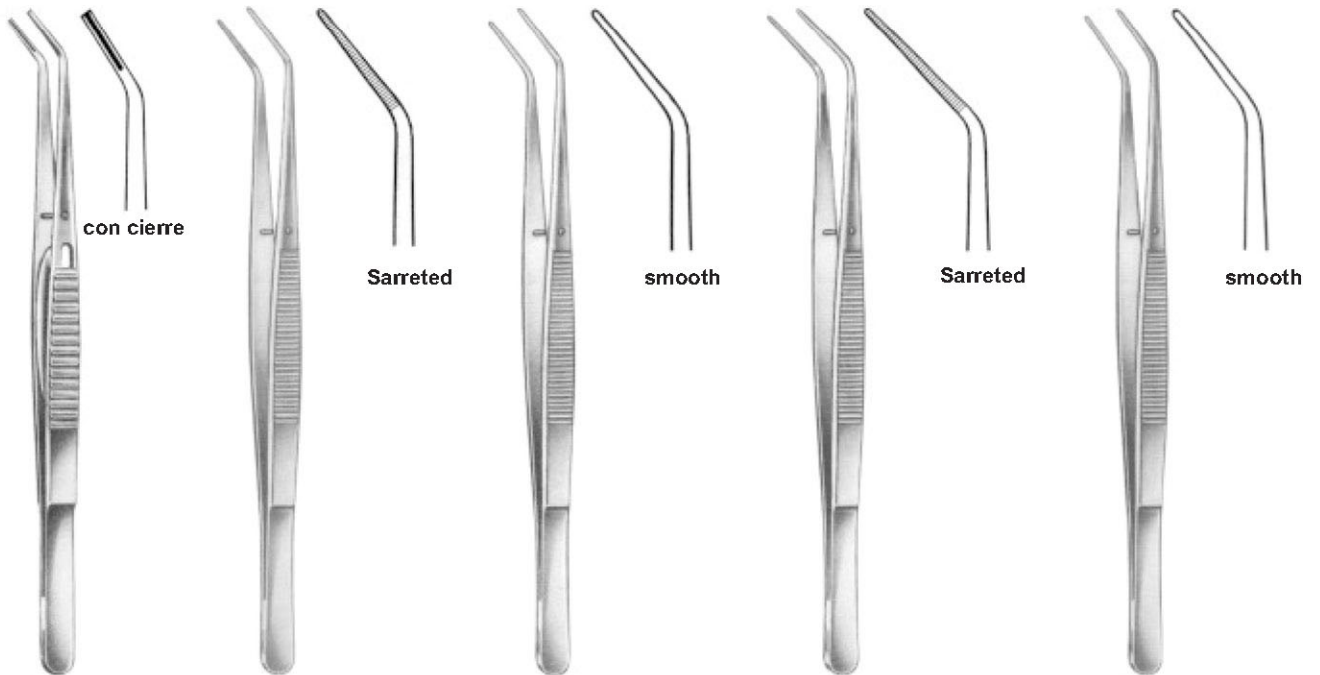

**2521**  
15,5 cm, 6 1/8"

**2522**  
LONDON-COLLEGE  
15 cm, 6"

**2523**  
LONDON-COLLEGE  
15 cm, 6"

**2524**  
LONDON-COLLEGE  
15 cm, 6"

**2525**  
LONDON-COLLEGE  
15 cm, 6"



Dental Tweezers



**2526**  
LONDON-COLLEGE  
15 cm, 6"



**2527**  
LONDON-COLLEGE  
15 cm, 6"



**2528**  
MERIAM  
16 cm, 6 1/4"



**2529**  
ALLEN  
18 cm, 7 1/8"



**2530**  
ALBRECHT  
16 cm, 6 1/4"



**2531**  
ALBRECHT  
16 cm, 6 1/4"



**2532**  
16 cm, 6 1/4"



**2533**  
16 cm, 6 1/4"



**2534**  
16 cm, 6 1/4"





**Sterilizing & Lab Instruments**

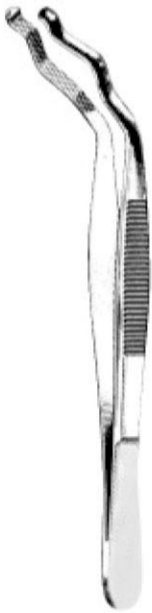

**2535**  
DAVID  
6"



**2536**  
Grasping Forceps  
6 1/4"



**2537**  
Mesh Bur & Daimond Holder  
Large, 2 1/8" Diameter



**2538**  
Soldering Tweezer  
6 1/4"



**2539**  
Narrow Fine  
4 3/4"



**2540**  
Super Fine  
4 3/8"



**2541**  
Fine CURved  
4 1/2"



**2542**  
Bonding Bracket  
Holder  
136 mm



**2543**  
Bonding Bracket  
Holder  
135 mm



**2544**  
Bonding Bracket  
Holder  
135 mm



**2545**  
Bonding Bracket  
Holder  
140 mm





Endodontic Forceps



**2546**  
Endo Forceps  
4 3/4"



**2547**  
PEETS Forceps  
4 3/4", Useful For  
Removing Broken  
Instruments

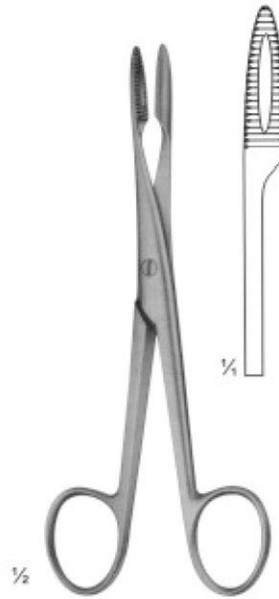

**2548**  
Without Ratchet  
145 mm

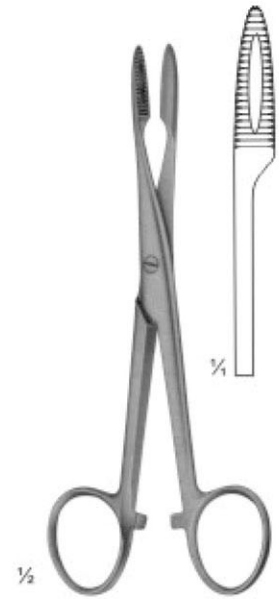

**2549**  
Without Ratchet  
145 mm



**2550**  
CRILE  
140 mm

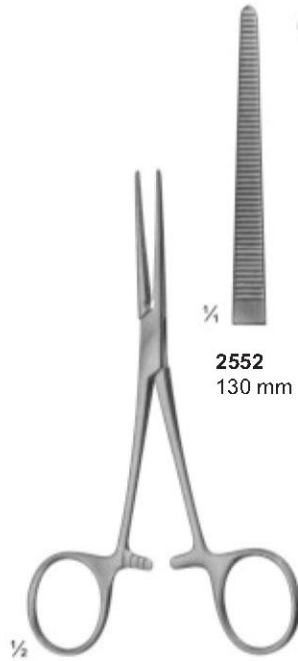

**2551**  
PEAN  
Slender type

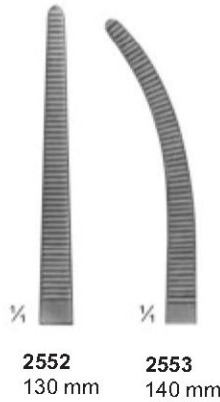

**2552**  
130 mm

**2553**  
140 mm

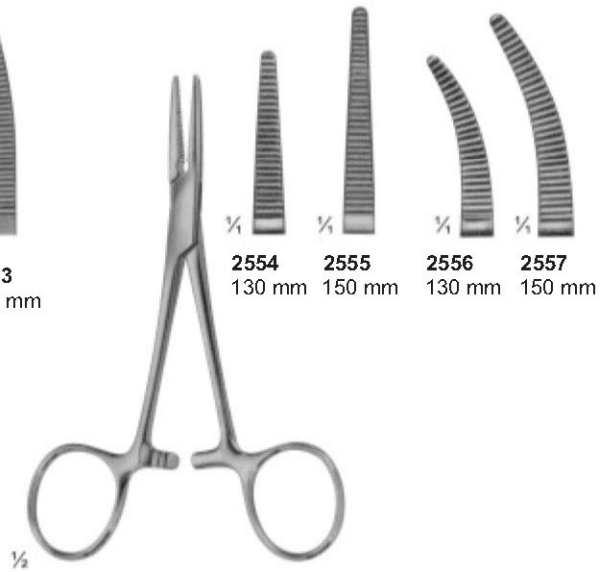

**2554**  
SPENCER-WELLS

**2554**  
130 mm

**2555**  
150 mm

**2556**  
130 mm

**2557**  
150 mm



Tissue Forceps



**2558**  
BABY-ALLIS  
5", Straight  
4x5 teeth extra delicate



**2559**  
ALLIS  
6", Straight  
4x5 teeth extra delicate



**2560**  
ALLIS  
6", Straight  
4x5 teeth extra delicate



**2561**  
1x2 teeth  
6"



**2562**  
SWMKIN  
6", Straight  
1x2 teeth



**2563**  
ADSON  
4 3/4"  
1x2 teeth



**2564**  
BROWN-ADSON  
4 3/4"  
7x7 teeth



**2565**  
BROWN  
6"  
8x8 teeth



**2566**  
RUSSIAN  
6"  
8x8 teeth



**2567**  
Extra-Delicate  
Straight, 4"  
1x2 teeth



Hemostatic Forceps, Towel Clamps, Napkin Holders



**2568**  
HALSTED-MOSQUITO  
Straight, Curved, 5"



**2569**  
HALSTED-MOSQUITO  
Straight, Curved, 5  
1x2 teeth"



**2570**  
HALSTED-MOSQUITO  
Jaws 45 Angle on Flat, 5"  
Extra Delicate



**2571**  
KELLY  
5 1/2", Straight



**2572**  
JONES  
3 1/2"



**2573**  
BACKHAUS  
3 1/2"



**2574**  
BACKHAUS  
5 1/4"



**2575**  
LORNA  
non Preferated  
3 1/2"



Retractors, Depressors, Mouth Gags



**2576**  
DENHART



**2577**  
DENHART  
Mouth Gag With  
Silicon Inserts,  
Interchangeable  
Size: 125 mm

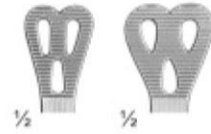

**2578**  
WIDER  
Tongue depressor  
**2579** 140mm  
**2580** 150mm



**2581**  
TOBOLD  
Tongue depressor  
Size: 145 mm



**2582**  
ANDREW  
Tongue depressor  
Size: 110 mm

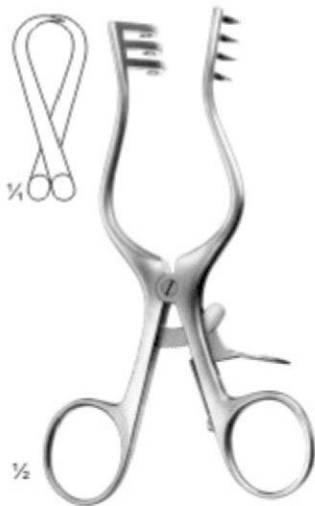

**2583**  
WEITLANER  
Sharp  
130 mm

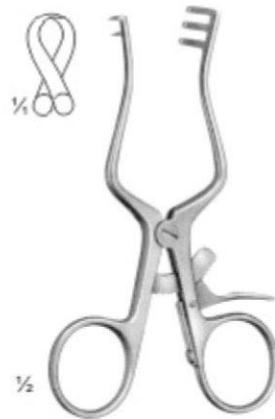

**2584**  
WEITLANER  
Sharp  
110 mm

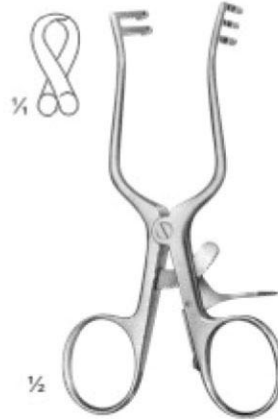

**2585**  
WEITLANER  
Semi-Sharp  
110 mm



**2586**  
MOLT  
Pediatric

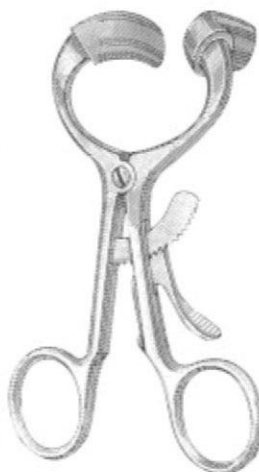

**2587**  
MOLT  
Child



**2588**  
MOLT  
Adult



**2589**  
FERGUSSON-ACKLAND  
Mouth Gag  
Size: 145 mm



**2590**  
ROSER KOENIG  
Mouth Gag  
Size: 160mm / 185 mm



Lip & Cheek Retractor

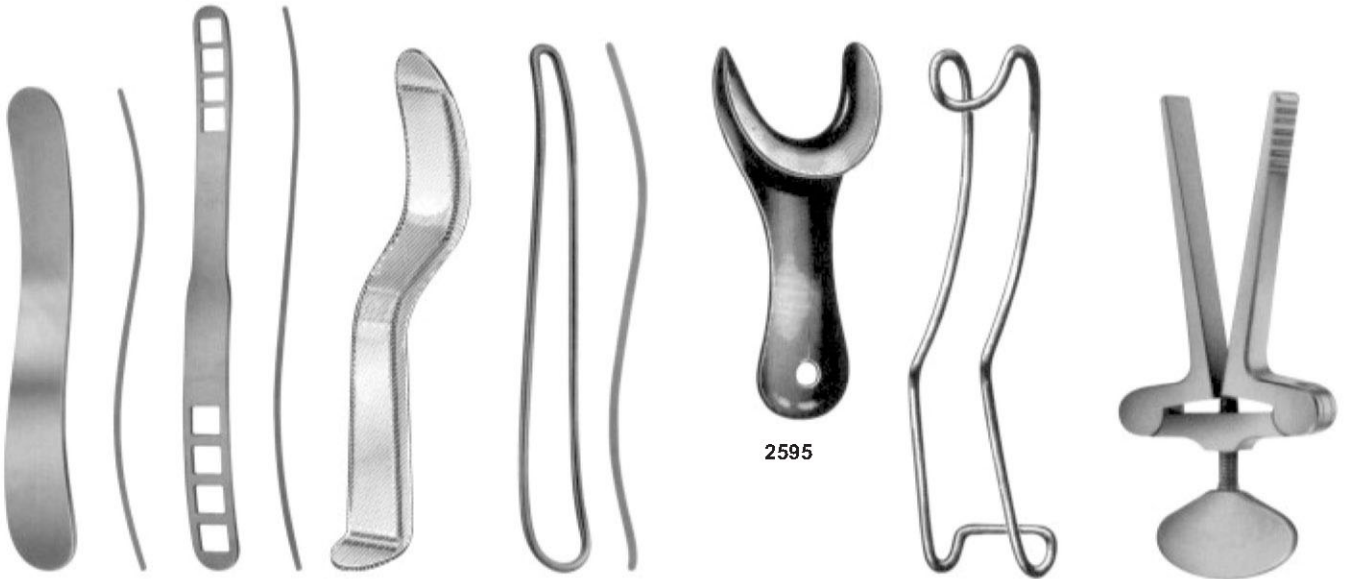

**2591**  
140 mm

**2592**  
BRUENINGS  
190 mm

**2593**

**2594**

**2595**

**2596**

**2597**

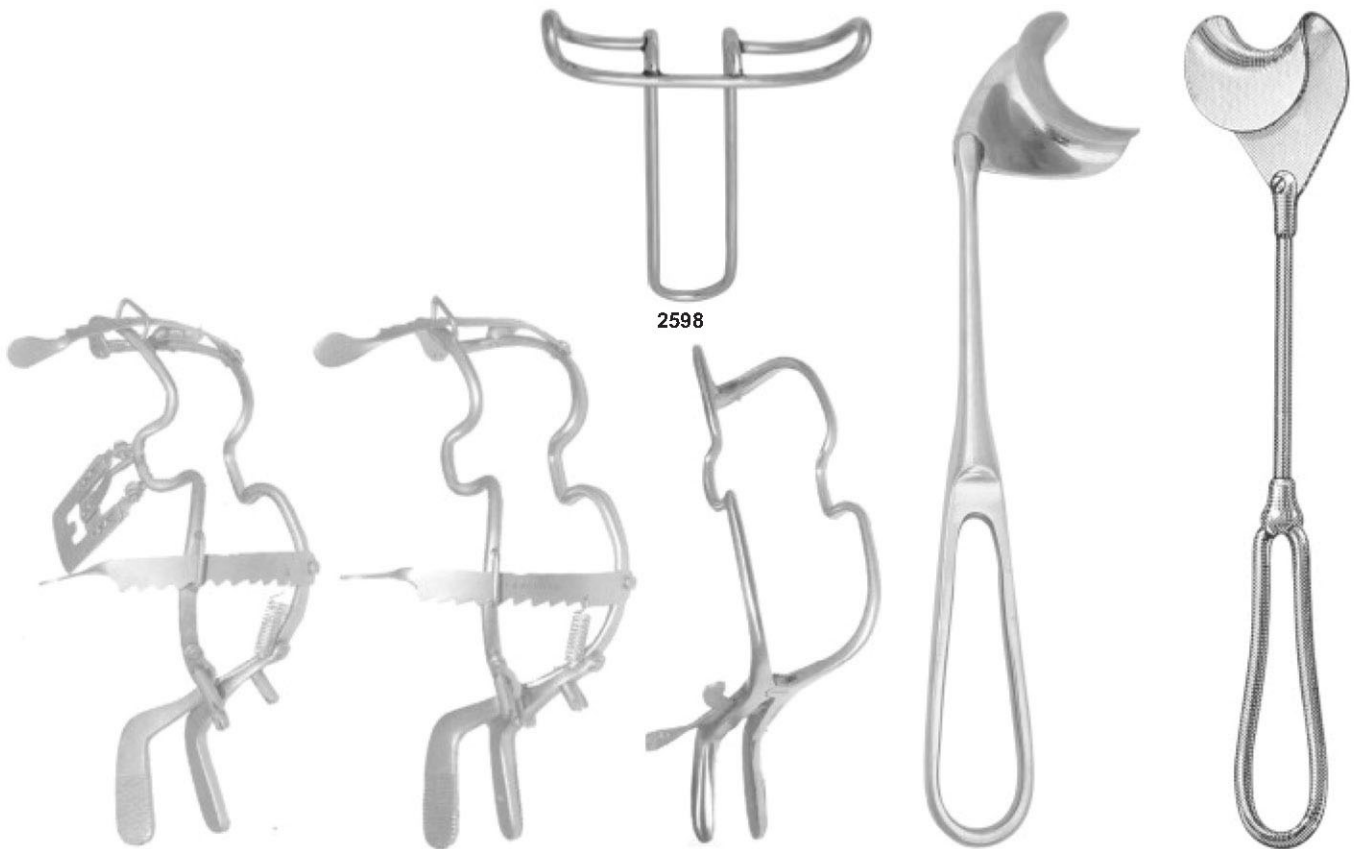

**2598**

**2599**  
Mouth Gag with  
Tongue Depressor  
11.0 cm  
13.0cm  
15.0 cm

**2600**  
Mouth Gag with  
Tongue Depressor  
11.0 cm  
13.0cm  
15.0 cm

**2601**  
Jenings, Mouth Gag  
11.0 cm  
13.0cm  
15.0 cm

**2602**

**2603**



# Lip & Cheek Retractor



**2604**  
LANGBECK  
210 cm



**2605**  
KOCHER-LANGBECK  
215 cm



**2606**  
BUCHS  
205 cm



**2607**  
KOCHER  
230 cm



**2608**  
MIDDELDORPF



**2609**  
15 x 15 mm  
220 mm



**2610**  
20 x 22 mm  
215 mm



**2611**  
28 x 28 mm  
235 mm



**2612**  
KOCHER  
230 mm



**2613**  
COLLIN  
150 mm



**2614**  
ROUX  
Set  
165 mm



## Strelizing Forceps



**2615**  
Sterilizing Forceps Curved  
20 cm A  
25 cm B  
30 cm C



**2616**  
Sterilizing Forceps Curved  
20 cm A  
25 cm B  
30 cm C



**2617**  
Sterilizing Forceps  
30 cm



**2618**  
Becht Tweezer



**2619**  
Sterilizing Forceps  
23 cm A  
30 cm B



**2620**  
Sterilizing Forceps  
20 cm



## Tissue Retractors & Hooks



**2621**  
3 sharp prongs



**2622**  
2 sharp prongs  
6"



**2623**  
2 sharp prongs  
6"



**2624**  
FOMON  
145 mm



**2625**  
ALM  
70 mm



**2626**  
SENN  
3 sharp prongs  
6 3/8"



**2627**  
TOENNIS  
Dura Retractor  
150mm



**2628**  
JOSEPH  
165 mm



**2629**  
GILLIES  
180 mm





Orthodontic Pliers



**2630**  
Wire Cutter



**2631**  
Wire Cutter



**2632**  
Posterior Band Remover  
Long



**2633**  
Posterior Band Remover  
Short

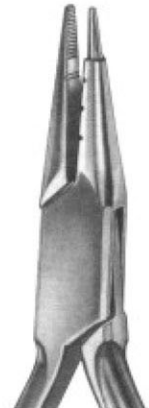

**2634**  
Jarabak Plier  
Short



**2635**  
Distal End Cutter  
Safety End Cutter



**2636**  
Distal End Cutter



**2637**  
Kim's Plier

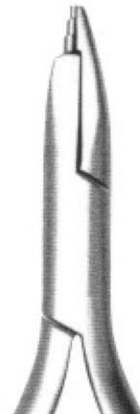

**2638**  
Loop Forming Plier



**2639**  
Tweed Arch Bending Plier



**2640**  
Utility Plier



**2641**  
Banding Bracket Remover



**2642**  
Lingual Arch Plier



**2643**  
Light Wire Plier



**2644**  
Wire Cutter  
12.5 cm



# Orthodontic Pliers

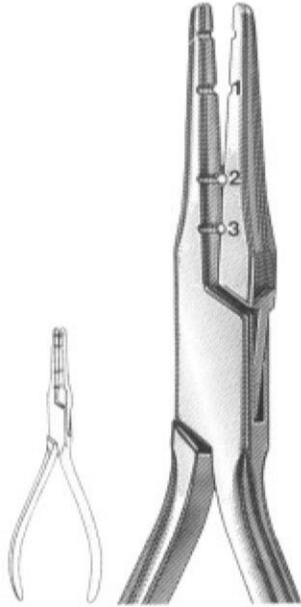

**2645**  
Fig. 101  
Wire Bending

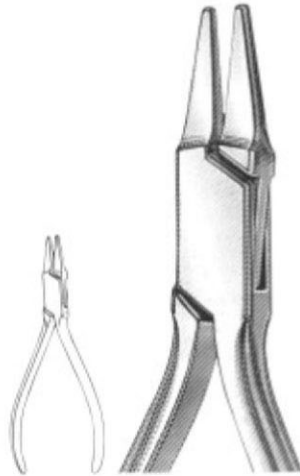

**2646**  
Fig. 118  
PEESO  
Collar

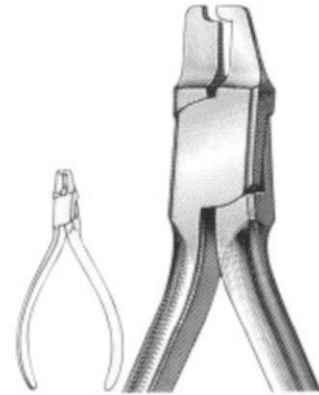

**2647**  
Fig. 417  
Crown Shell

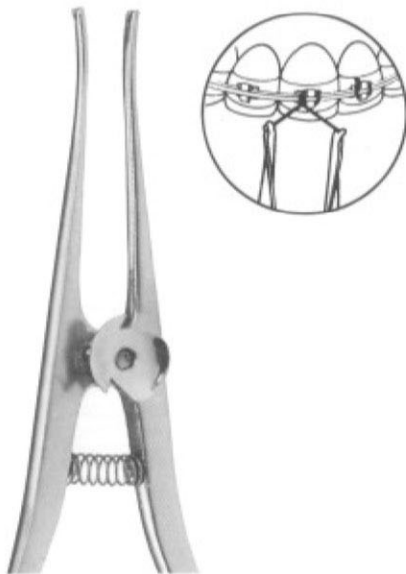

**2648**  
STEINER  
150 mm  
Ligature Pliers

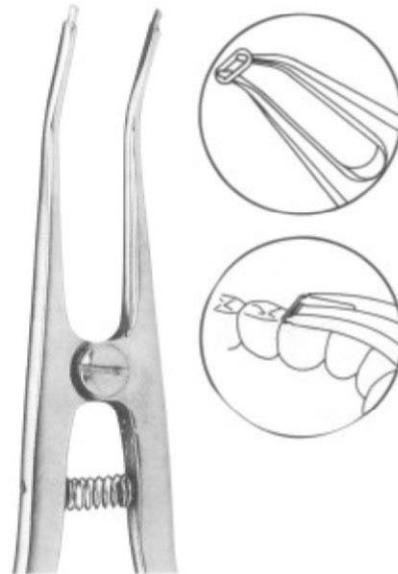

**2649**  
Separating Pliers Elastics  
150 mm



**2650**  
121-Lab & Offical



Orthodontic Pliers

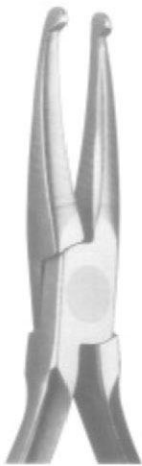

**2651**  
How Plier-Titanium Alloy  
With special coated beaks

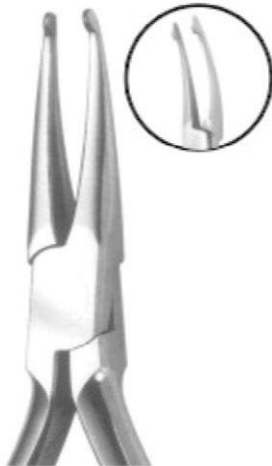

**2652**  
How Plier  
Tips are 1/8"(3.2mm)  
diameter

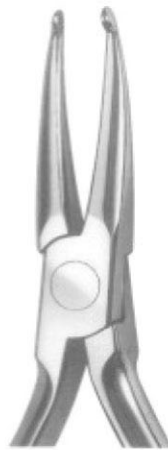

**2653**  
How Plier  
Tips are 1/8"(3.2mm)  
diameter



**2654**  
How Plier-Small  
Tips are 3/32(2.4mm)  
diameter

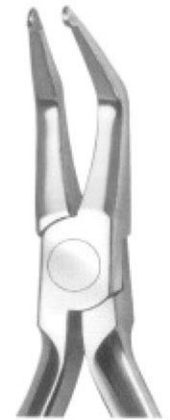

**2655**  
How Plier-Offset  
Tips are 1/8"(3.2mm)  
diameter

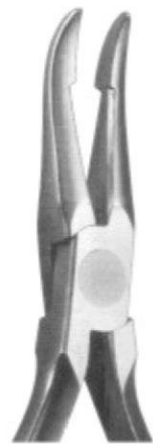

**2656**  
Weingart Utility Plier  
-Titanium Alloy  
with special coated beaks

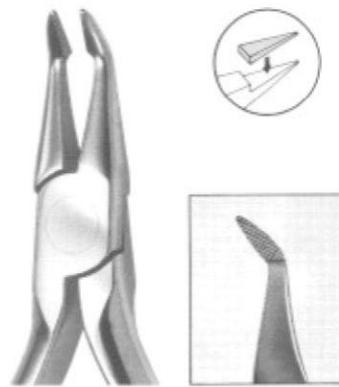

**2657**  
Weingart Utility Plier  
New type of the Weingart Utility Plier  
designed for a more precise operation.

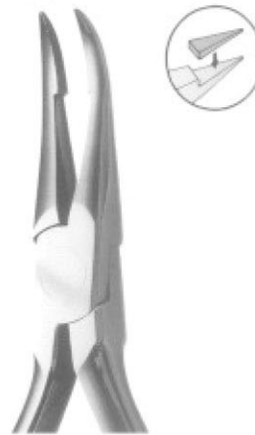

**2658**  
Weingart Utility Plier

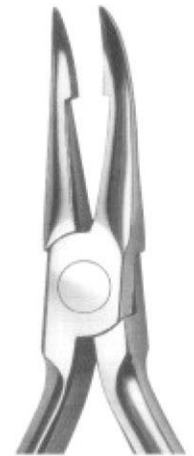

**2659**  
Weingart Utility Plier

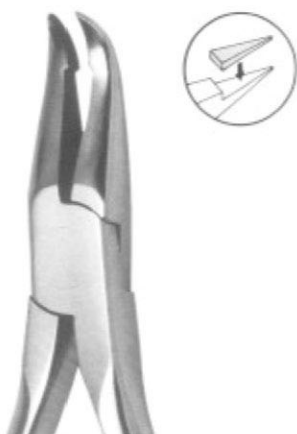

**2660**  
Weingart Utility Plier

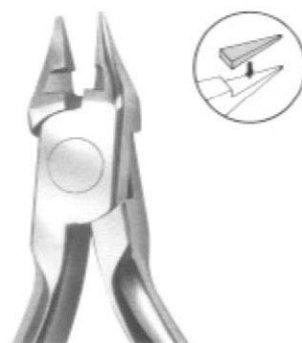

**2661**  
Bird Beak Plier With Cutter  
**Maximum Bending & Cutting Capacity:**  
Wire up to .032"



**2662**  
Bird Beak Plier  
**Maximum Bending Capacity:**  
Wire up to .032"

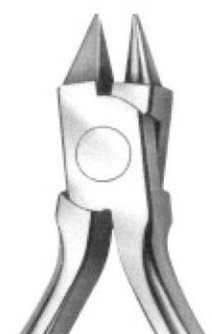

**2663**  
Bird Beak Plier  
**Maximum Bending Capacity:**  
Wire up to .030



Orthodontic Pliers



**2664**  
TWEED (Fig. 98)  
13 cm, 5 1/8"  
Tweed Loop Omega Pliers.

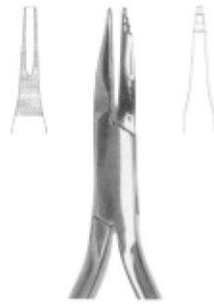

**2665**  
TWEED (Fig. 90)  
14 cm/5 1/2"



**2666**  
TWEED (Fig. 97)  
14 cm/5 1/2"

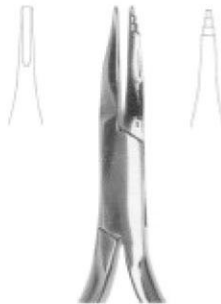

**2667**  
TWEED (Fig. 96)  
14 cm/5 1/2"

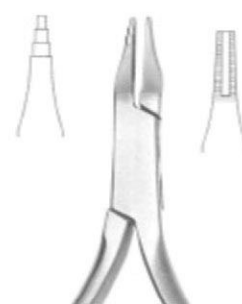

**2667**  
TWEED (Fig. 95)  
13.5 cm, 5 1/4"

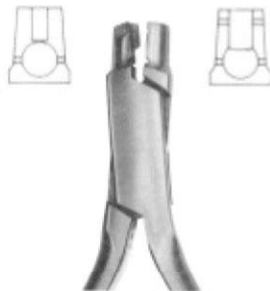

**2669**  
SCHWARX (Fig. 29)  
12.5 cm, 5"



**2670**  
NANCE (Fig. 80)  
13 cm/5 1/8"

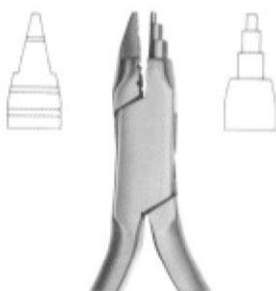

**2671**  
YOUNG (Fig. 55)  
13 cm/5 1/8"



**2672**  
SCHWARZ (Fig. 30)  
13 cm/5 1/8"

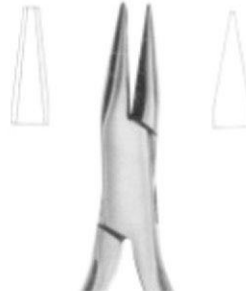

**2673**  
Optical Plier (Fig. 53)  
14 cm, 5 1/2"

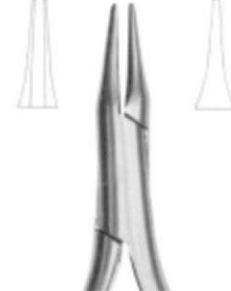

**2674**  
Schwarz (Fig. 30)  
13.5 cm/5 1/4"



Orthodontic Pliers



**2675**  
NANCE (Fig. 56)  
12.5 cm, 5"  
Wire bending Pliers

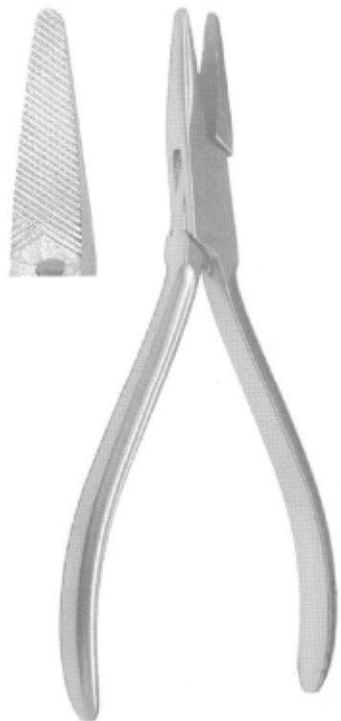

**2680**  
14.0 cm  
Goslee Countouring Plier



**2676**  
JOHNSON (Fig. 59)  
13.5 cm, 5 1/4"  
Countouring Plier.



**2677**  
REYNOLDS (Fig. 61)  
3.5 cm, 5 1/4"  
Countouring Plier.



**2678**  
De La Rosa (Fig. 34)  
12.5 cm, 5"  
Countouring Plier, Non-Grooved



**2679**  
De La Rosa (Fig. 34)  
12.5 cm, 5"  
Countouring Plier, Non-Grooved

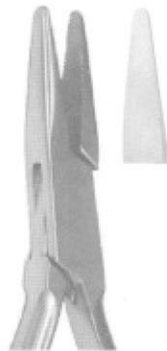

**2681**  
14.0 cm  
Goslee Countouring Plier

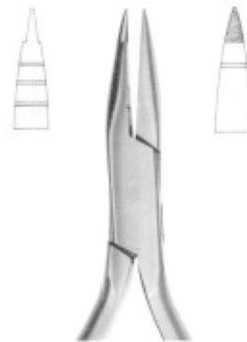

**2682**



**2683**  
Fig. 58  
12.5 cm, 5"  
Lingual Arch Bending Plier

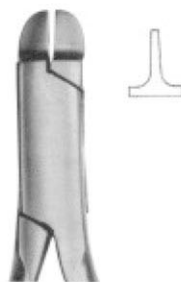

**2684**  
Frevort/Tweed (Fig. 51)  
12.5 cm, 5"  
Tweed Arch Plier/Standard Jaw

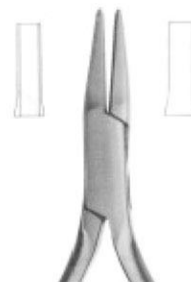

**2685**

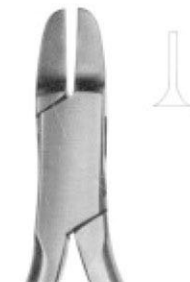

**2686**  
ANGLE (Fig. 52)  
13 cm, 5 1/8"  
Arch Forming Plier



## Orthodontic Pliers



**2687**  
Fig.60  
13 cm, 5 1/8"  
Wire & Clasp Bendind Pliers

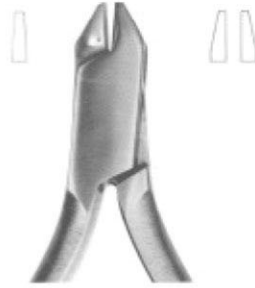

**2688**  
Fig.60  
13 cm, 5 1/8"  
Wire & Clasp Bendind Pliers

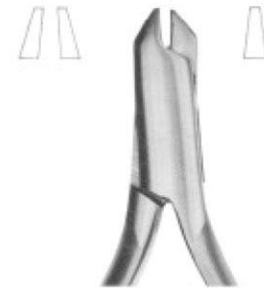

**2689**  
Aderer (Fig. 57)  
12 cm, 4 3/4"  
Wire & Clasp Bendind Pliers



**2690**  
49 e 49 TC  
14 cm, 5 1/2"  
Wire & Clasp Bendind Pliers



**2691**  
50 e 50 TC  
14 cm, 5 1/2"  
Band Removing Plier, Long Pad



**2692**  
Fig. 84  
14 cm, 5 3/4"  
Band Pinshing & ligature  
locking plier, serrated



**2693**  
Fig. 72  
14 cm, 5 1/2"  
Band Pinshing & ligature  
locking plier, serrated



**2694**  
BRACKET (Fig.82)  
13.5 cm, 5 1/4"  
Direct Bounding Bracket Remover



**2695**  
BRACKET (Fig.83)  
13.5 cm, 5 1/4"  
Direct Bounding  
Bracket Remover



Orthodontic Pliers



**2696**  
38c, 38 TC  
13.5 cm, 5 1/4"  
Countouring closing loop pliers,  
wire bending, cutter

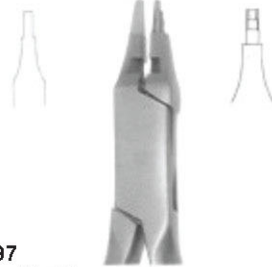

**2697**  
40c, 40 TC  
13.5 cm, 5 1/4"  
Countouring closing loop pliers,  
grooved with cutter



**2698**  
Fig. 81  
12.5 cm, 5"  
Sling clasp & wire bending plier



**2699**  
Fig. 25  
14 cm, 5 1/2"  
Sling clasp & wire bending plier



**2700**  
Fig. 21  
13 cm, 5 1/7"  
Light wires pliers, grooved



**2704**  
46c-56 TC  
ADAMS-N. 139c  
12.5 cm, 5"  
Bird beak with cutter.



**2701**  
ADAMS, 23, 23TC  
12.5 cm, 5"  
Sling clasp & wire bending plier



**2702**  
ADAMM (Fig.33)  
12.5 cm, 5"  
For retaining elements.



**2703**  
ADAMS, (Fig.44)  
12.5 cm, 5"  
Sling clasp & wire bending plier



**2705**  
Universal Wire Bwnding  
Pliers (ADAMS) 47 TC, N.64  
12.5 cm, 5"  
Sling clasp & wire bending plier.



**2706**  
86c, 86 TC  
Angle Birds Beak -N. 138  
12.5 cm, 5"  
Sling clasp & wire bending plier.



Orthodontic Cutters With T.C.



**2707**  
Fig. 18 TC  
15 cm, 6"



**2708**  
Fig. 92 TC  
14 cm, 5 1/2"



**2791**  
Fig. 91 TC  
13 cm, 5 1/8"



**2710**  
Fig. 99 TC  
13 cm, 5 1/8"



**2711**  
Fig. 94 TC  
13 cm, 5 1/8"  
Angled at with or  
without spring on /  
the handles

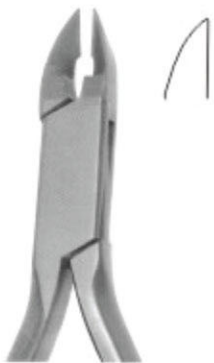

**2712**  
Fig. 74 TC  
13 cm, 5 1/8"



**2713**  
Fig. 7 TC  
13 cm, 5 1/8"



**2714**  
Fig. 85 TC  
Angled at 15  
13 cm, 5 1/8"



**2714**  
ADAMS 87TC  
Angled at 15  
13 cm, 5 1/8"





### Orthodontic Distal & Cutters





Pliers for Orthodontic & Prosthetics



**2721**  
UNIVERSAL  
150 mm

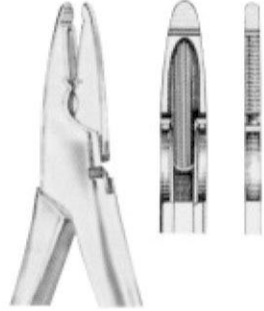

**2722**  
WALDSACHSL  
150 mm



**2723**  
ADERER  
125 mm

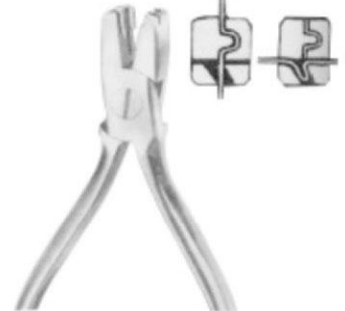

**2724**  
NANCE  
125 mm

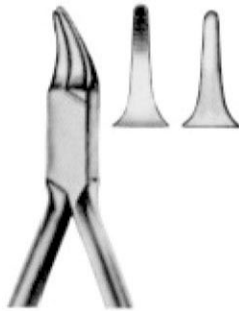

**2725**  
REYNOLDS  
125 mm

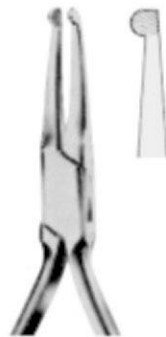

**2726**  
HOW  
145 mm



**2727**  
HOW  
140 mm



**2731**  
FURRER  
150 mm

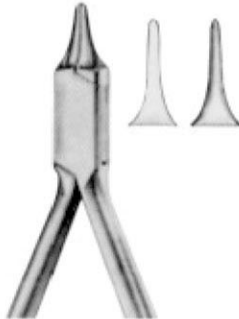

**2728**  
WALDRON  
125 mm

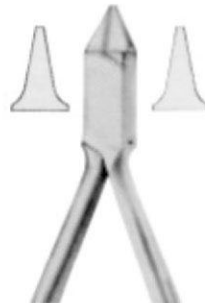

**2729**  
ADAMS  
125 mm



**2730**  
ANGLE  
125 mm

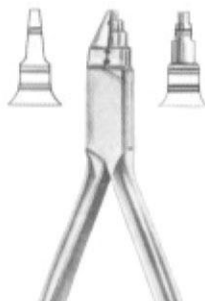

**2732**  
YOUNG  
130 mm



**2733**  
NANCE  
130 mm



Pliers for Orthodontic & Prosthetics



**2734**  
LANGBECK  
125 mm

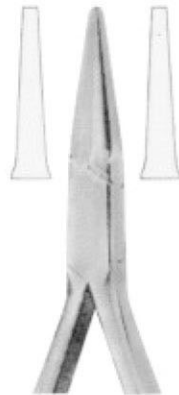

**2735**  
LANGBECK  
140 mm



**2736**  
LANGBECK  
130 mm

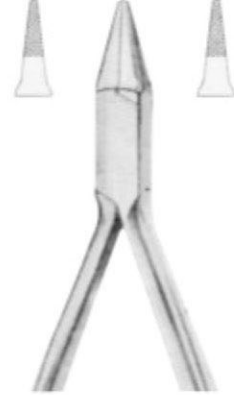

**2737**  
PESSO  
125 mm

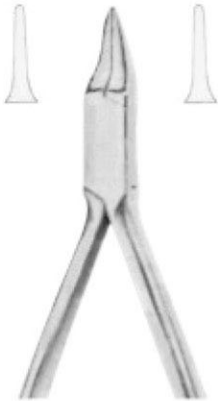

**2738**  
GOSELEE  
125 mm

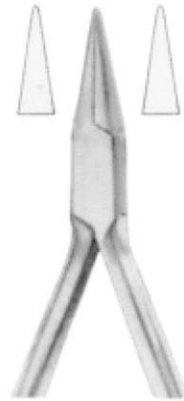

**2739**  
FISCHER  
140 mm

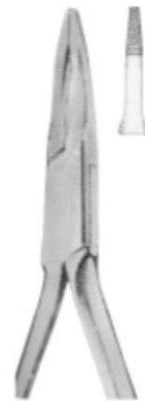

**2740**  
FISCHER  
140 mm

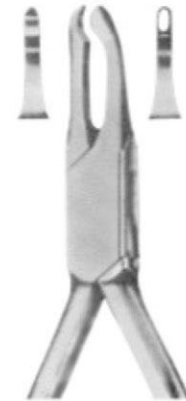

**2741**  
JOHNSON  
130 mm

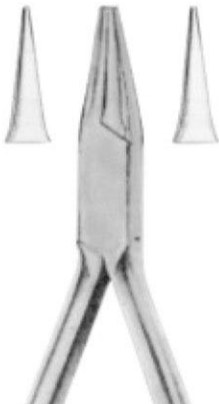

**2742**  
MSY  
130 mm

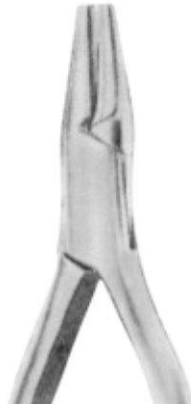

**2743**  
MC KELLOPS  
15 mm



**2744**  
ANDRESEN  
130 mm

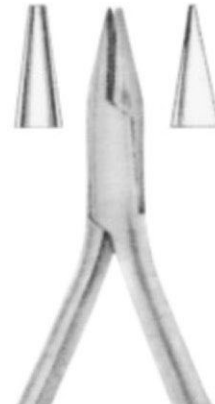

**2745**  
SCHWARZ  
130 mm



Rongeurs



2746  
BLUMENTHAL  
6", 30, Standard

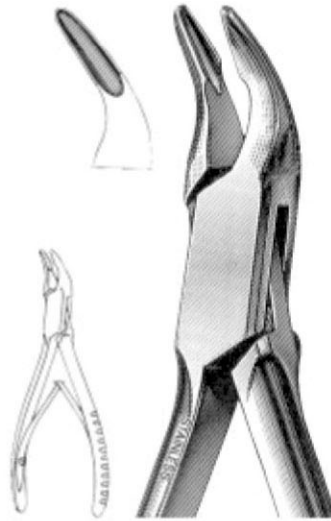

2747  
MINI-BLUMENTHAL  
6", 35

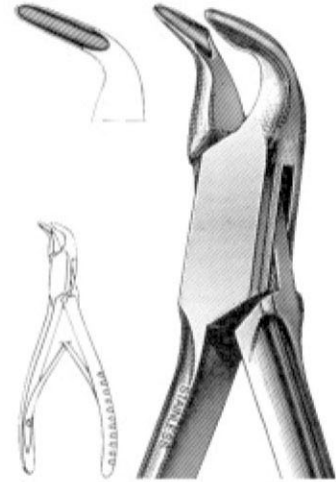

2748  
MINI-BLUMENTHAL  
6", 90

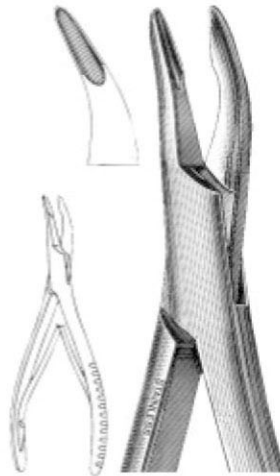

2749  
BLUMENTHAL  
7", 30

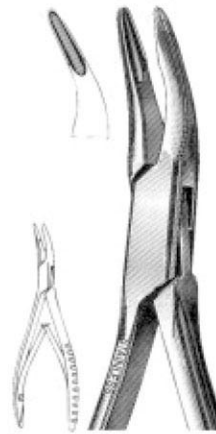

2750  
MINI-BLUMENTHAL  
4 1/2", 30

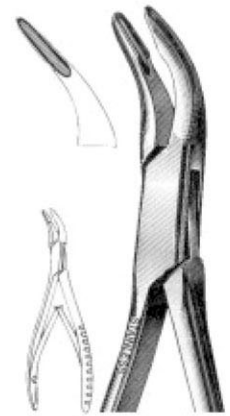

2751  
MINI-BLUMENTHAL  
4 1/2", 45



Rongeurs

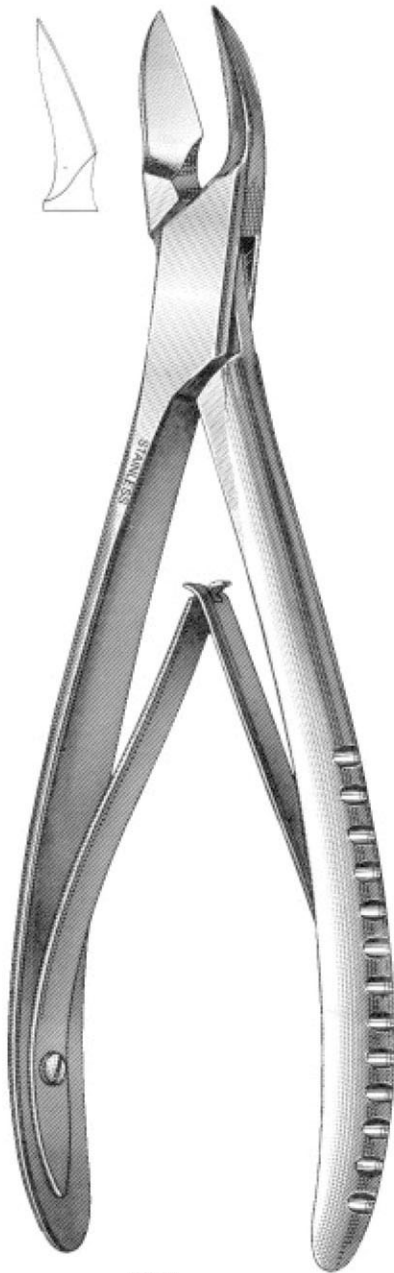

**2752**  
CLEVELAND  
No. 5-Side Cutting,  
6 3/4"

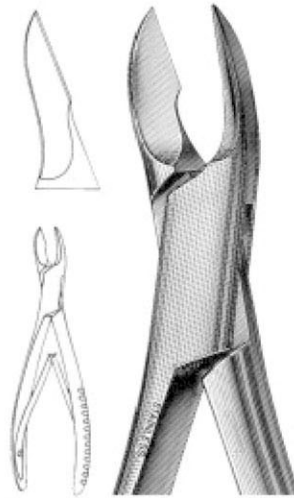

**2753**  
CLEVELAND  
No. 5A-Side Cutting,  
6 1/2"

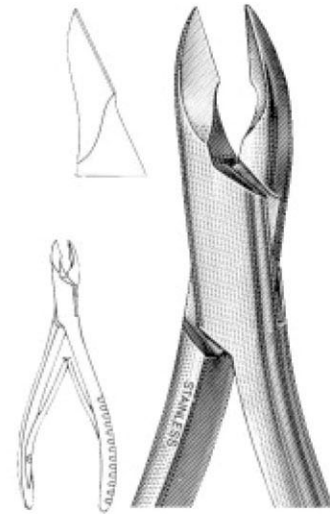

**2754**  
CLEVELAND  
No. 5S-Side Cutting,  
6"

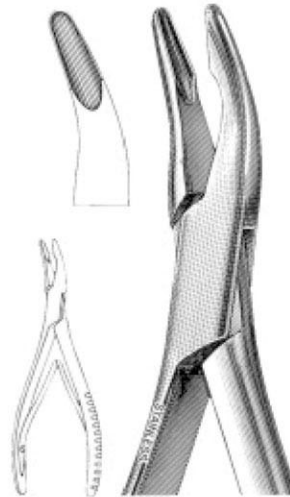

**2755**  
No. 1A-MEAD  
6 1/2"

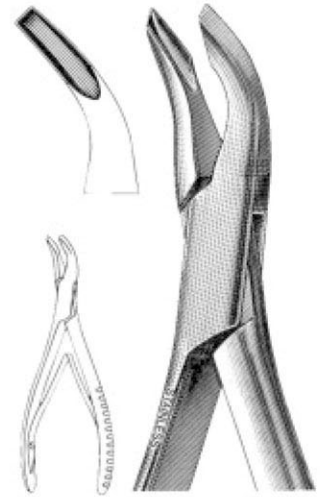

**2756**  
MEAD, Square  
No. 2A  
Tips, 6 1/2"

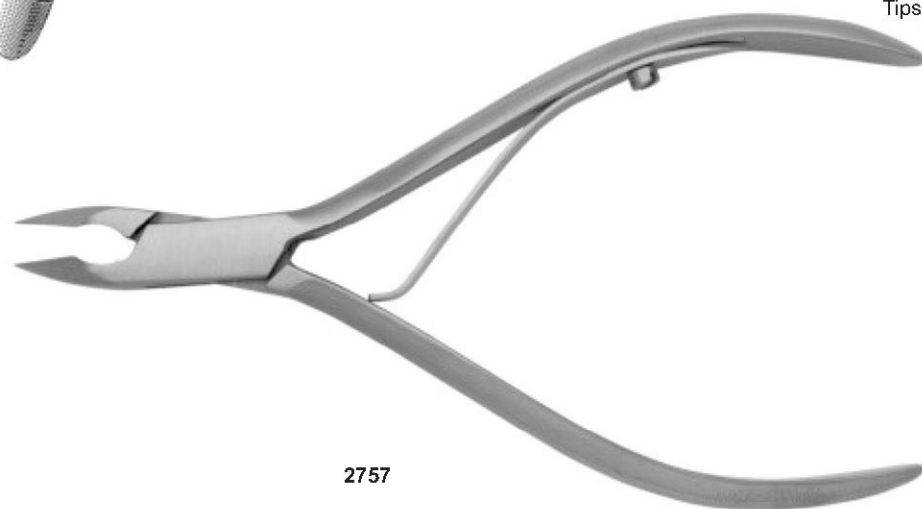

**2757**



Rongeurs



2757  
FRIEDMAN  
5 1/2"

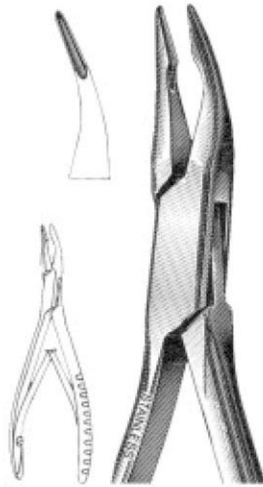

2758  
MICRO-FRIEDMAN  
5 1/2", 15 Curved Jaws

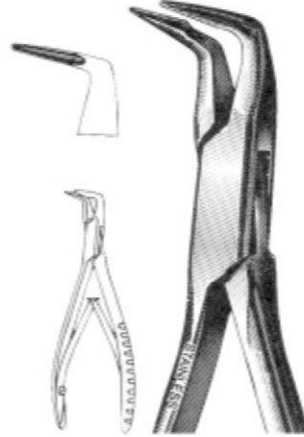

2759  
MICRO-FRIEDMAN  
Perio Rongeur, 5 1/2"

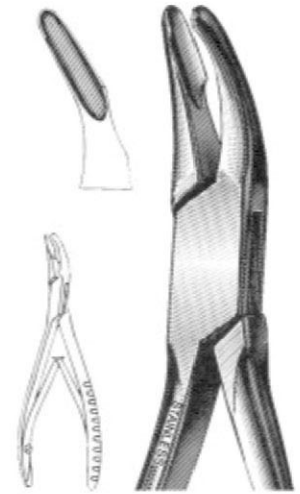

2760  
CLEVELAND  
No. 4-5 1/2"

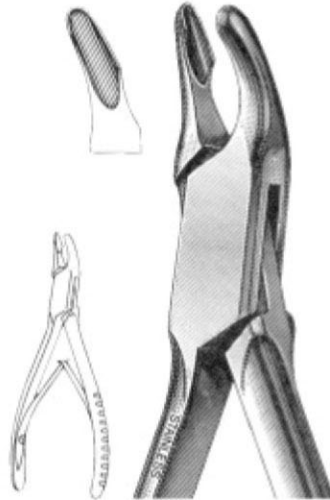

2761  
CLEVELAND  
No. 4A-6 1/2"

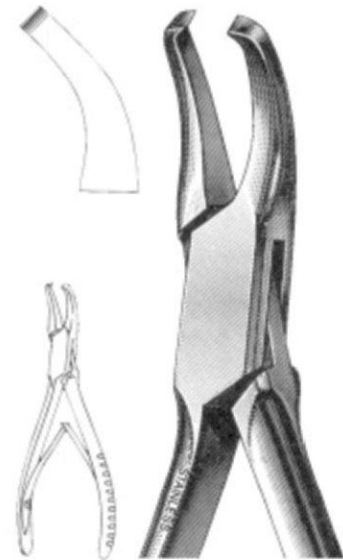

2761  
GARDNER  
No. 6A, End Cutting  
6 1/2"



Rongeurs



**2763**  
BEYER  
Double Action,  
16, 18 cm



**2764**  
No. 1  
6 1/2"

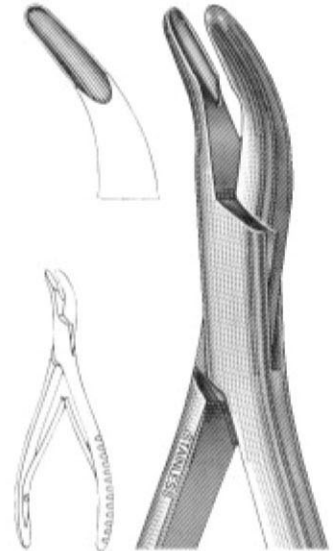

**2765**  
HARTMAN  
5 3/4"  
Strong Curve

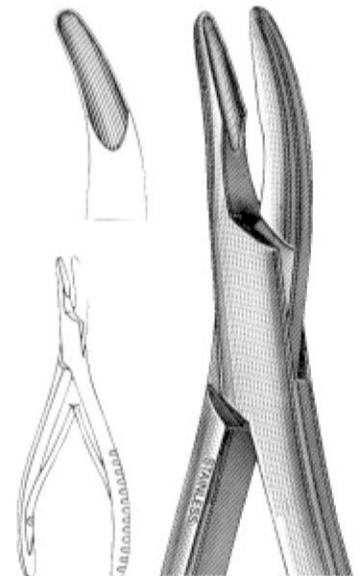

**2766**  
BANE  
Slight Curve  
7"



Needle Holders



**2767**  
COLLIER  
5", Fenestrated Jaws



**2768**  
DERF  
4 3/4"



**2769**  
WEBSTER  
Delicate Smooth Jaws  
5"



**2770**  
NEIVERT  
One Offset Ring  
5"



**2771**  
OLSEN-HEGAR  
5 1/2"



**2772**  
BAUMGARTNER  
5 1/2"



**2773**  
CRILE-WOOD  
6"



**2774**  
GARDNER  
6"





Needle Holders

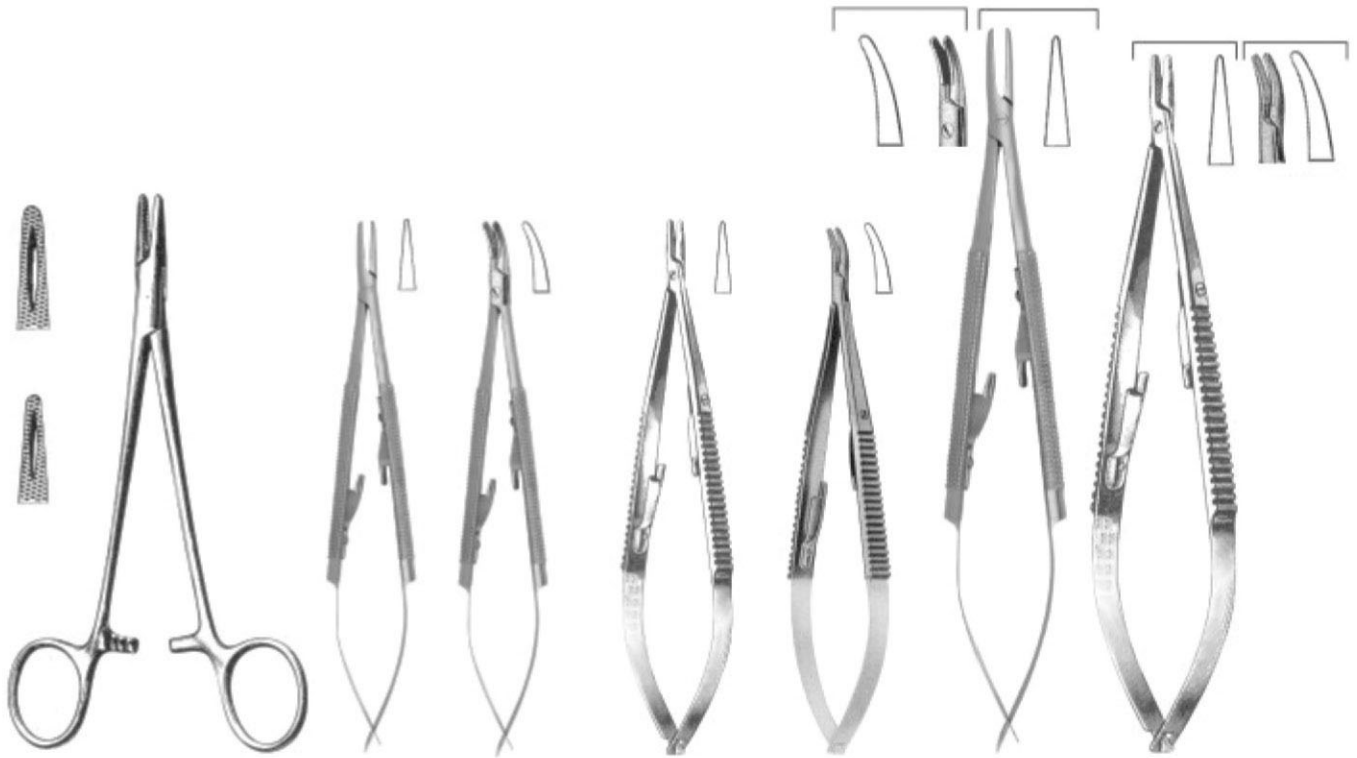

**2775**  
MAYO-HEGAR  
5"

**2776**  
CASTROVIEJO  
Smooth Jaws  
14 cm

**2777**  
CASTROVIEJO  
Smooth Jaws  
14 cm

**2778**  
CASTROVIEJO  
Smooth Jaws  
14 cm

**2778**  
CASTROVIEJO  
Smooth Jaws  
14 cm

**2779**  
CASTROVIEJO  
Smooth Jaws  
18 cm

**2780**  
CASTROVIEJO  
Smooth Jaws  
18 cm



**2781**  
BOYNTON  
5"

**2782**  
CRILE  
6"

**2783**  
MATHIEU  
5 1/2"

**2784**  
STEVENS  
6 1/2"



Micro Surgery Set



**2785**  
Micro Scissor  
Straight, 155 mm



**2786**  
Micro Scissor  
Straight, 150 mm



**2787**  
Micro Scissor  
Curved, 150 mm



**2788**  
Micro Scissor  
Curved, 155 mm



**2789**  
CASTROVIEJO  
T.C.  
Straight, 180 mm



**2790**  
Retractor  
Fig. 3  
165 mm



**2791**  
Micro Adson  
120 mm



**2792**  
GERALD  
Curved,  
150 mm



**2793**  
GERALD  
Straight.  
175 mm



**2794**  
Micro Adson  
160 mm

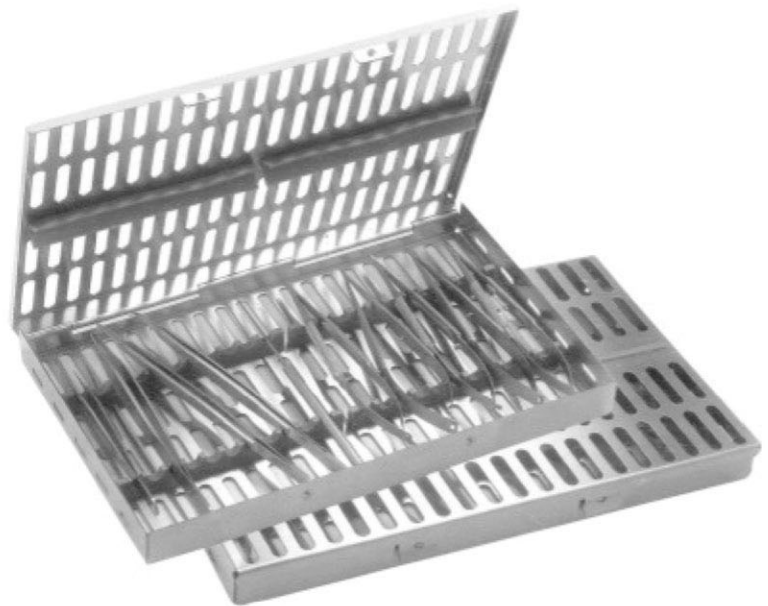

**2795**  
Micro Surgery Set 10 Pieces.



Scissors

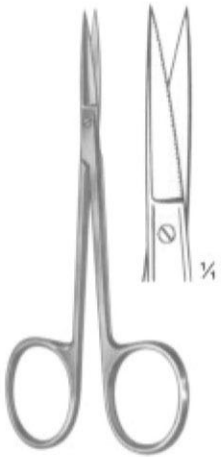

**2796**  
IRIS (Standard)  
Straight  
11.5 cm, 4 1/2"

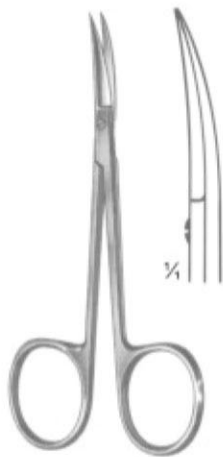

**2797**  
IRIS (Standard)  
Curved  
11.5 cm, 4 1/2"



**2798**  
STEVENS  
Dissecting Scissors  
Size: 115 mm



**2799**  
Sharp



**2800**  
Sharp



**2801**  
Blunt



**2802**  
Blunt



**2804**  
JOSEPH  
Size: 150 mm

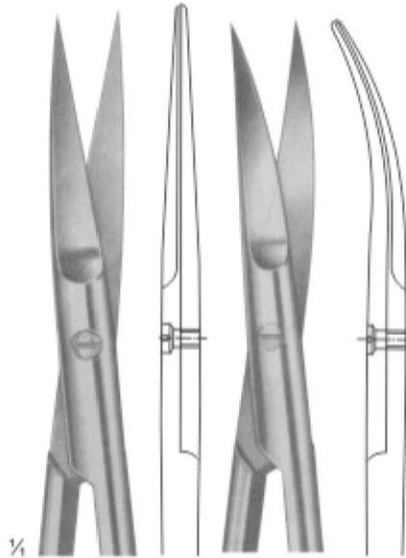

**2805**

**2805**

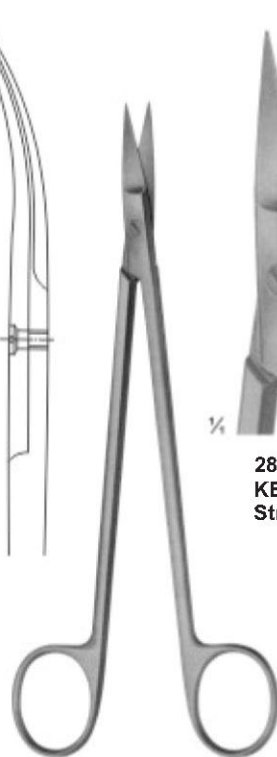

**2807**  
KELLY  
Size: 175 mm



**2808**  
KELLY  
Straight

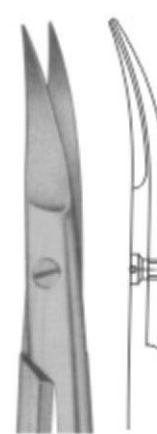

**2809**  
KELLY  
Curved

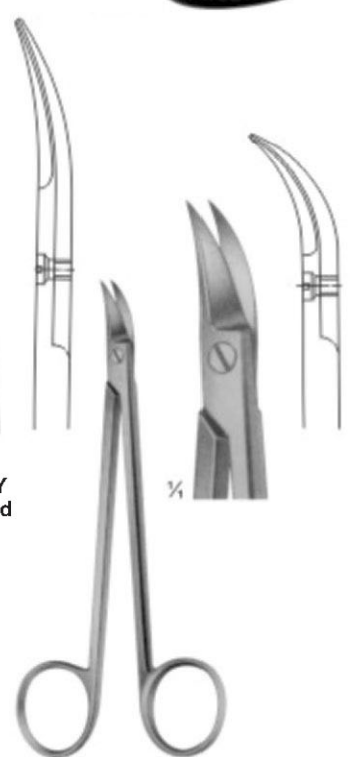

**2810**  
QUINBY  
Size: 130 mm



Scissors

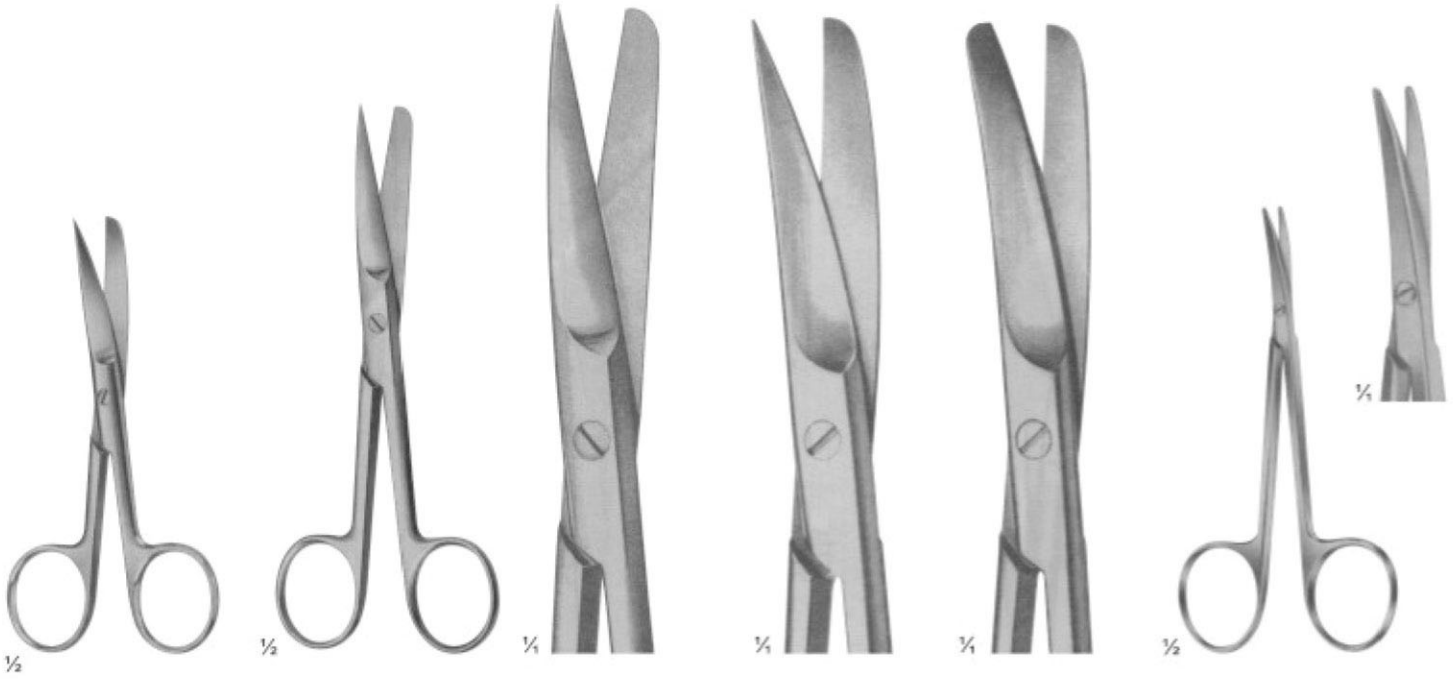

**2811**  
Standard - Types  
Size: 155 mm

**2812**  
DEEVER  
with flat lock

**2813**  
Size: 145 mm

**2814**  
Size: 145 mm

**2815**  
Size: 145 mm

**2816**  
LITTLER  
Dissecting Scissors  
Size: 145 mm

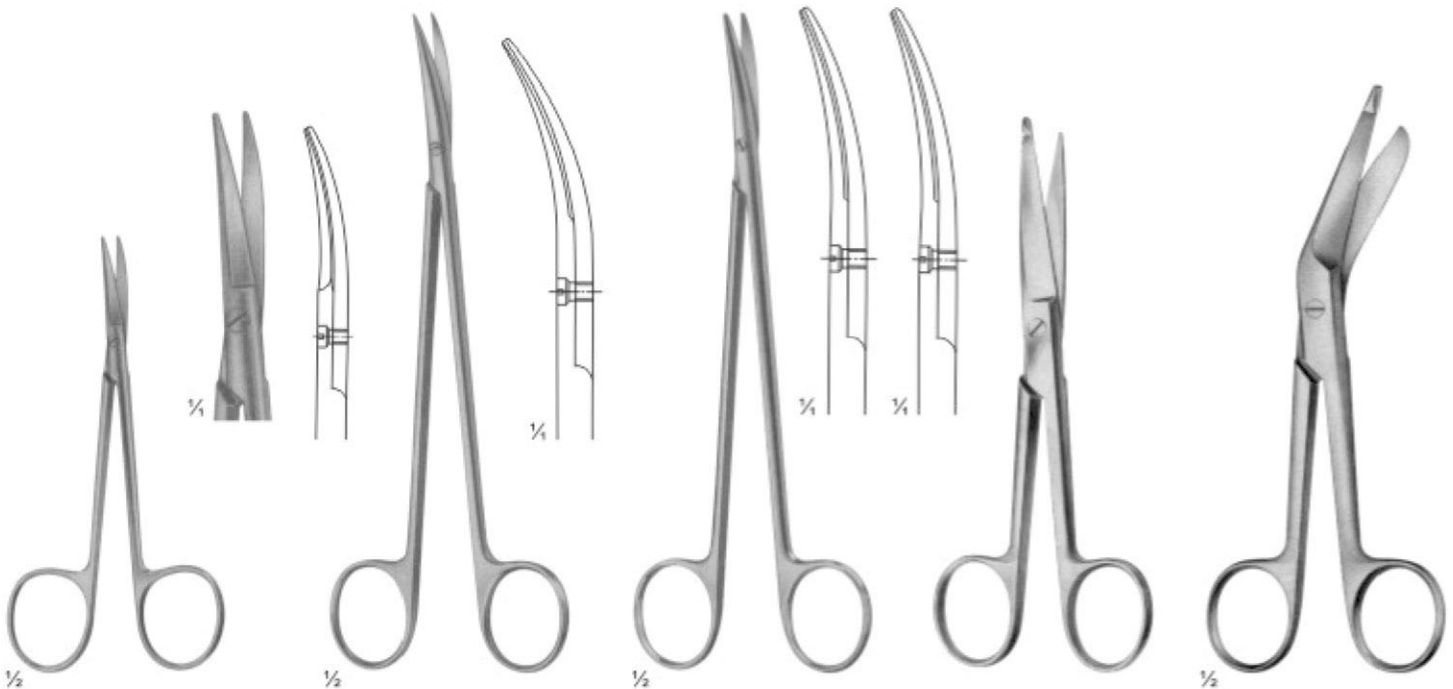

**2817**  
COTTLE  
Bulldog Scissors  
Size: 145 mm

**2819**  
DE BAKEY  
Ateriotomy scissors  
Size: 175 mm

**2819**  
TOENNIS-ADSON  
Dissecting scissors  
Size: 175 mm

**2820**  
KNOWLES  
Size: 145 mm

**2821**  
LISTER



Scissors

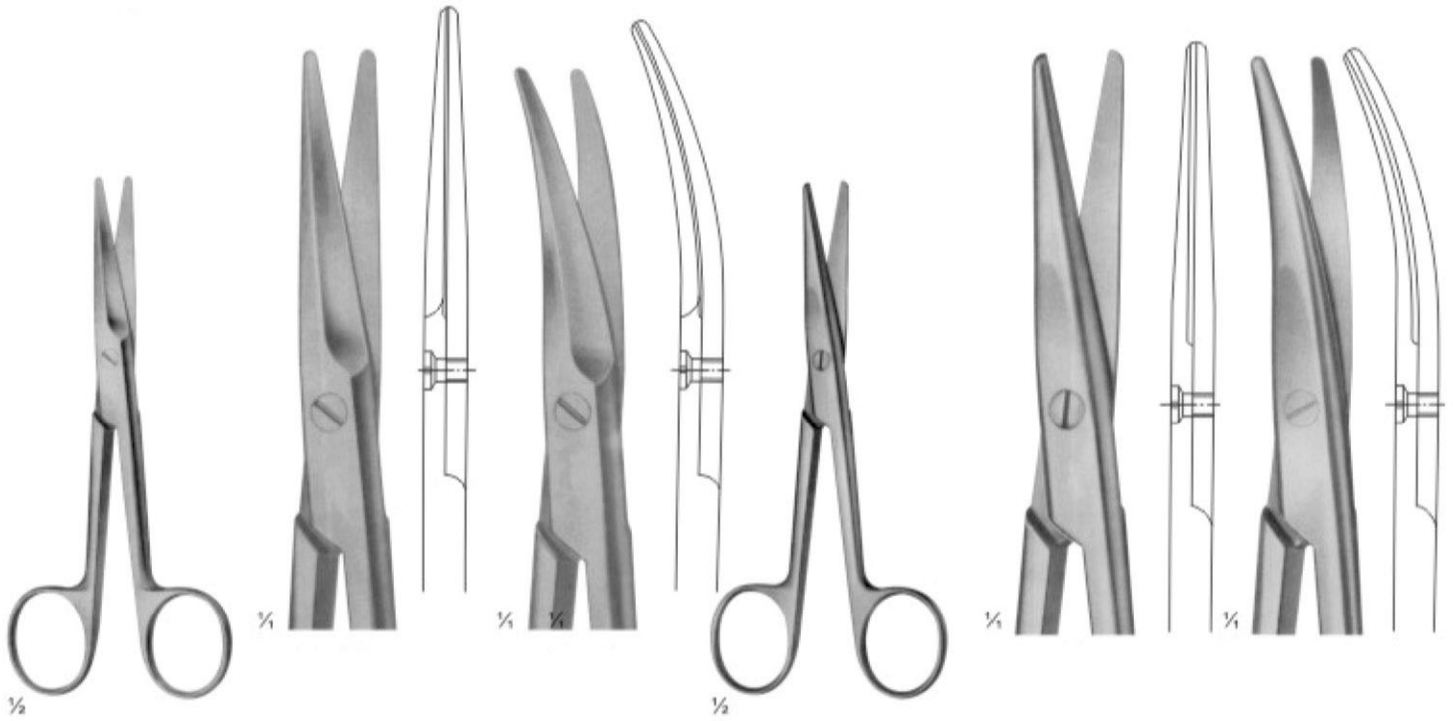

**2822**  
MAYO (Straight)  
Size: 140 mm

**2823**  
MAYO-STILLE (Straight)  
Size: 140 mm



**2824**  
STILLE  
Size: 140 mm

**2825**  
METZENBAUM  
Size: 115 mm

**2826**  
NELSON-METZENBAUM  
Size: 230 mm



Scissors



**2827**  
DE BAKEY  
Size: 155 mm

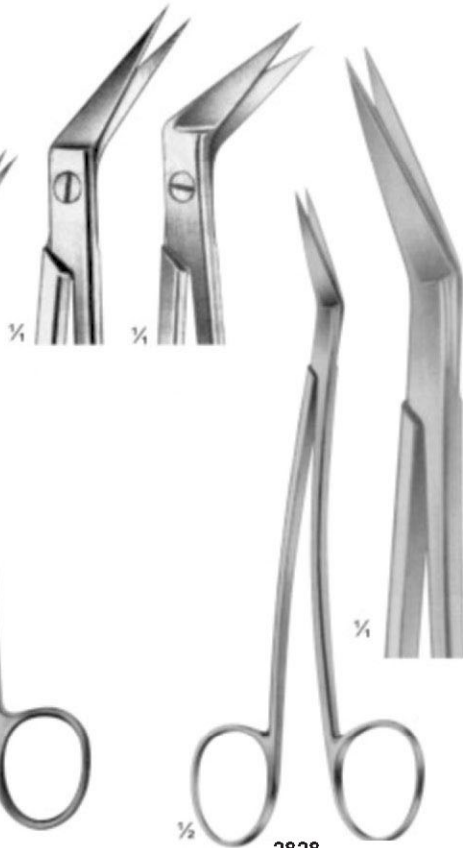

**2828**  
LOCKIN  
Curved Sideways,  
1 Toothed Blase  
Size: 155 mm



**2829**  
LAGrange  
Double-Curved  
11.5 cm



**2830**  
Goldman-Fox  
Double-Curved  
13 cm



**2832**  
LITTAUER  
Size: 135 mm

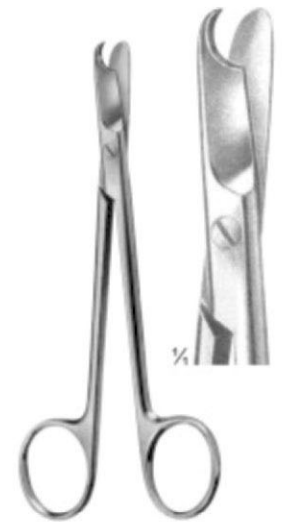

**2834**

**2835**

**2836**

**2837**

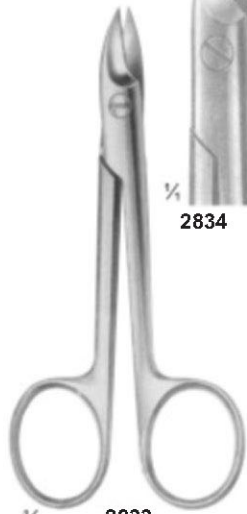

**2833**  
BEEBE  
Size: 110 mm



**2838**  
Dean  
17 cm

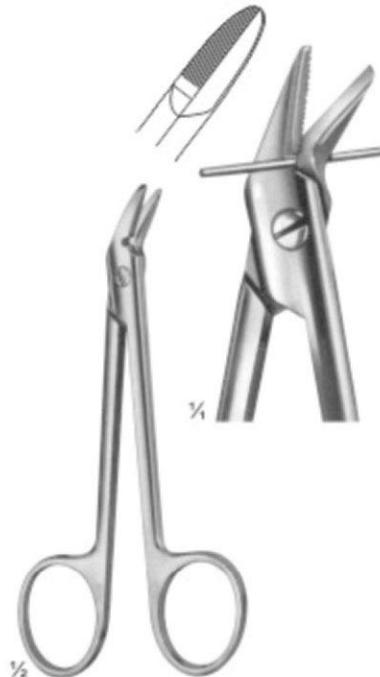

**2839**  
1 Blade Serrated  
Size: 120 mm

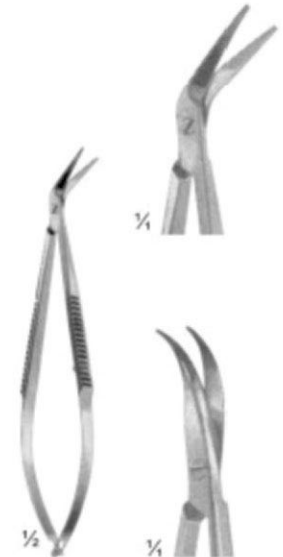

**2840**  
CASTROVIEJO  
Size: 90 mm



# Impression Trays

Made of 18/18 Stainless Steel, Sold, Set of 10

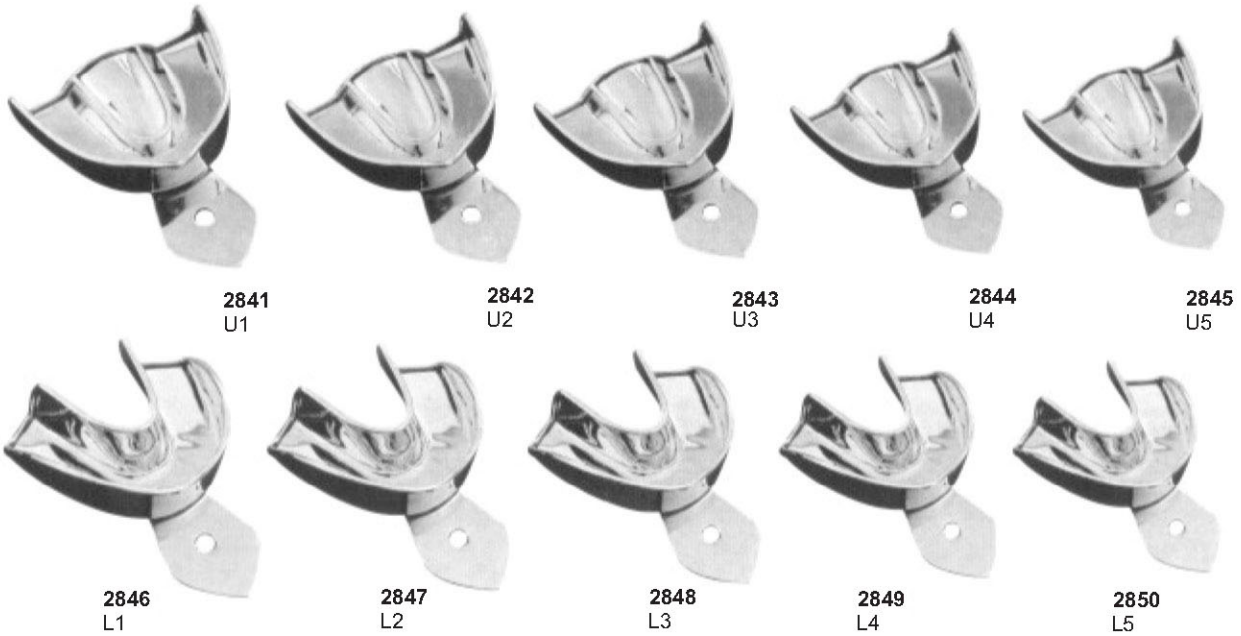

All The Above Impression Trays are Available in These 5 Sizes

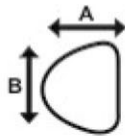

UPPER		U1	U2	U3	U4	U5
	A	62	60	53	54	52
B	83	75	73	69	68	

All Dimension are in mm

LOWER		L1	L2	L3	L4	L5
	A	63	61	57	60	53
B	82	81	78	74	71	

All Dimension are in mm

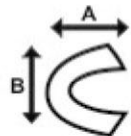

## Perforated, Set of 10

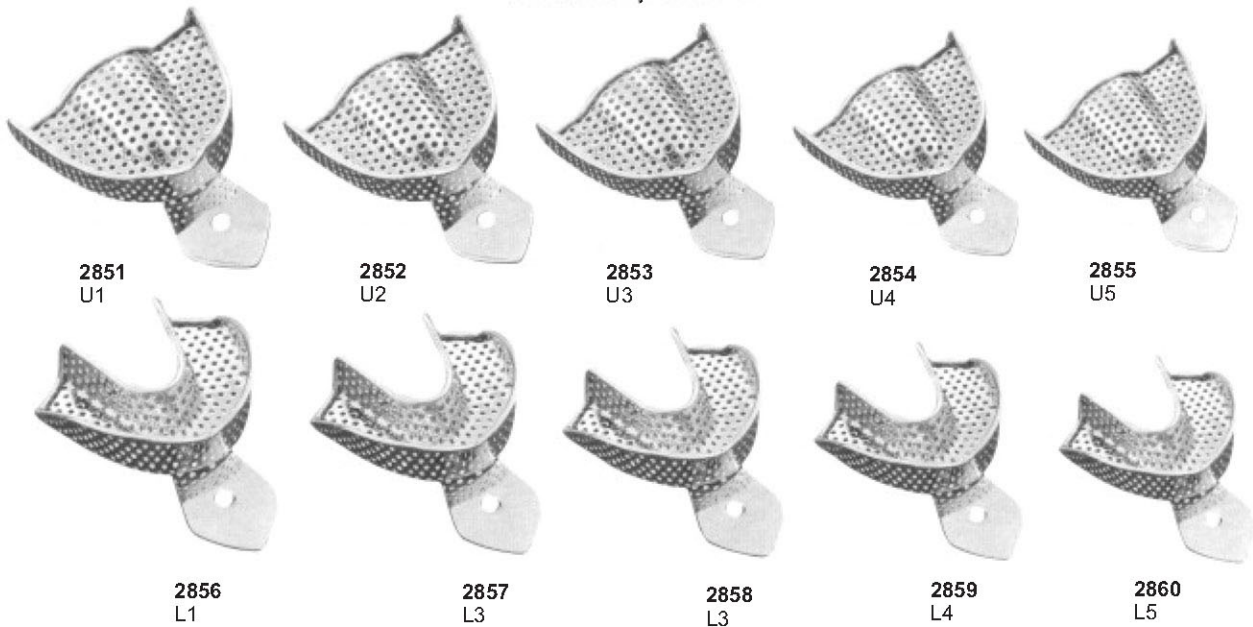



## Impression Trays

Made of 18/18 Stainless Steel, Full Denture Set of 8



2861  
XL

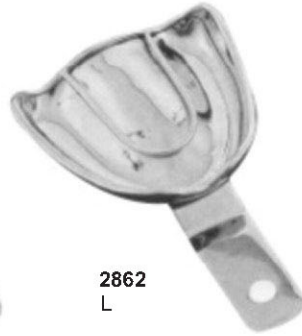

2862  
L

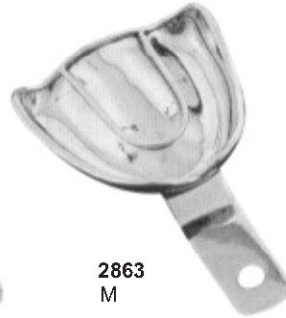

2863  
M



2864  
S



2865  
XL



2866  
L

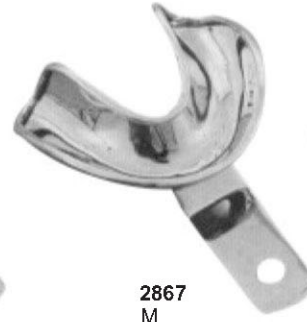

2867  
M

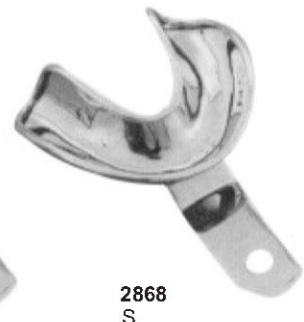

2868  
S

All The Above Impression Trays are Available in These 4 Sizes

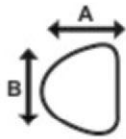

UPPER		XL	L	M	S
	A	70	67	64	60
B	79	76	70	73	

All Dimension are in mm

LOWER		XL	L	M	S
	A	64	64	60	57
B	86	70	73	70	

All Dimension are in mm

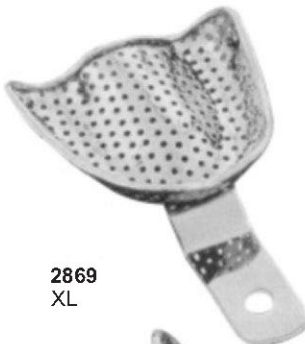

2869  
XL

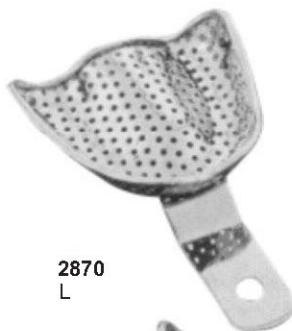

2870  
L

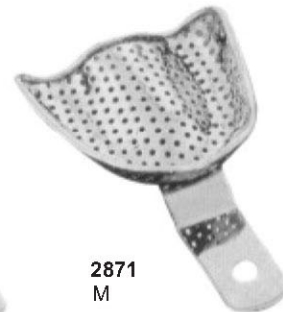

2871  
M



2872  
S



2873  
XL



2874  
L



2875  
M



2876  
S

Perforated, Full Denture Set of 8





## Impression Trays

Made of 18/18 Stainless Steel, English Pattern Set of 8

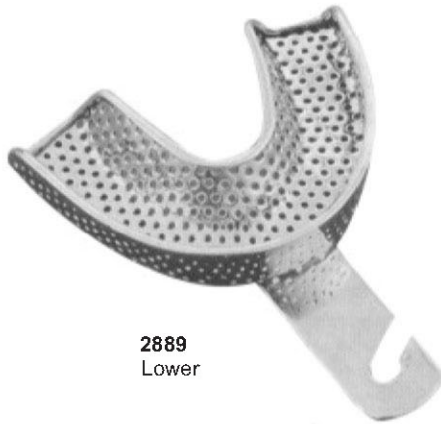

2889  
Lower

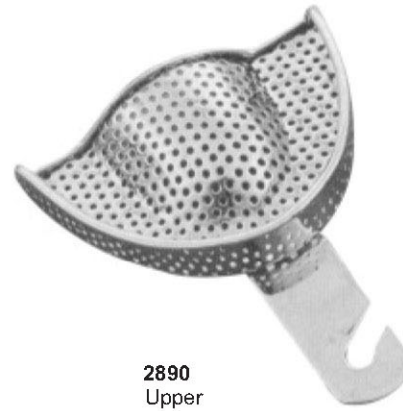

2890  
Upper

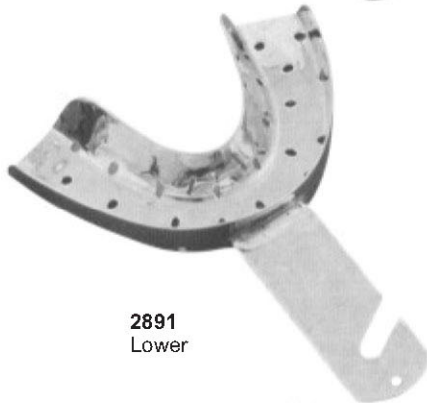

2891  
Lower

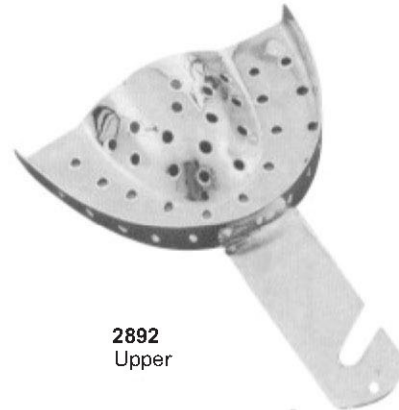

2892  
Upper



2893  
Lower



2894  
Upper

All The Above Impression Trays are Available in These 4 Sizes

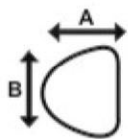

UPPER	Size	A	B	C
	0	67	50	12
	1	72	51	13
	2	78	55	15
	3	80	58	15

All Dimension are in mm

LOWER	Size	A	B	C
	0	70	50	14
	1	77	51	15
	2	79	55	15
	3	80	60	17

All Dimension are in mm

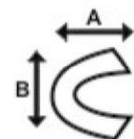



### Impression Trays

Made of 18/18 Stainless Steel, Solid Full Denture Set of 8

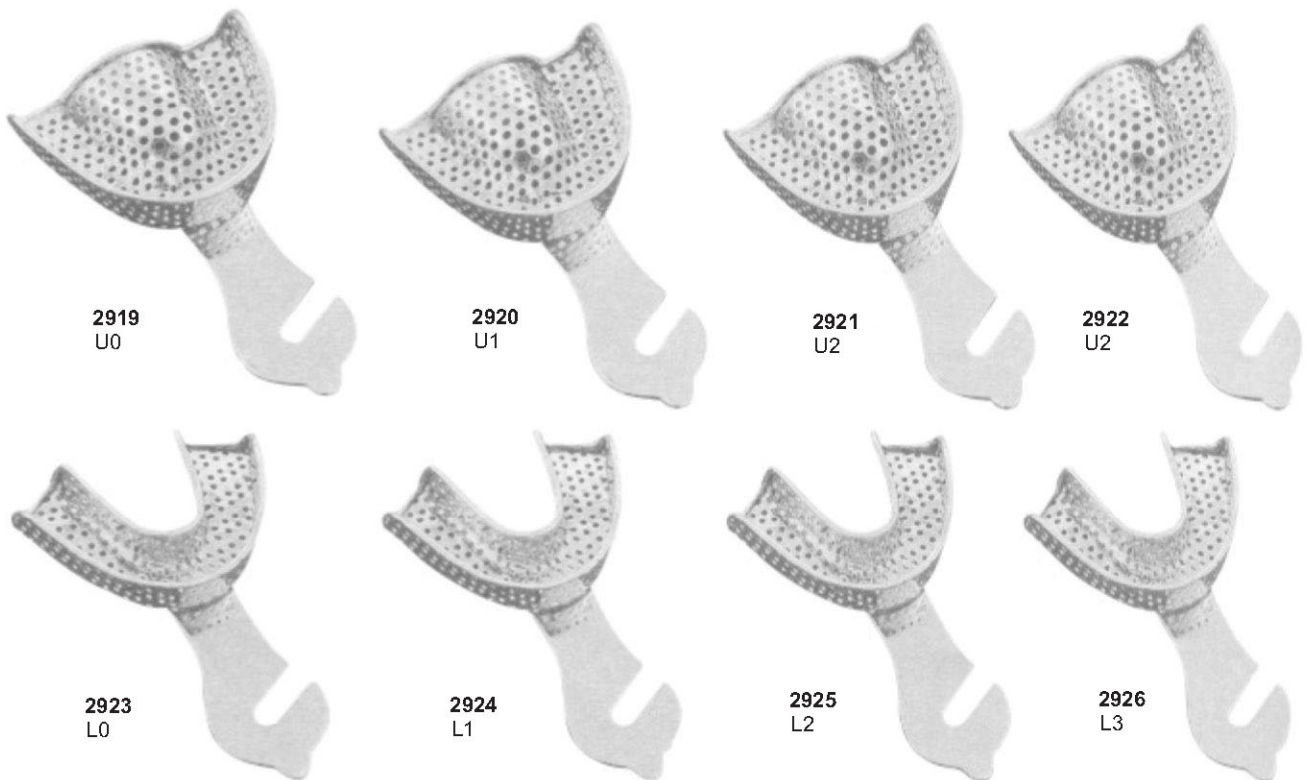
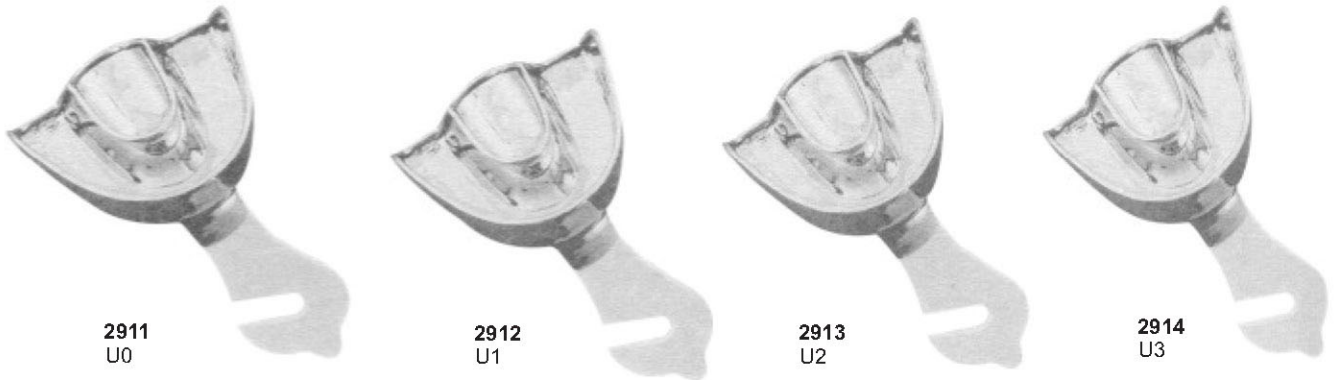

Made of 18/18 Stainless Steel, Preformed Full Denture Set of 8



# Impression Trays

## Impression Types For Crown & Bridge Work



2927  
U1P



2928  
L1P



2929  
U1P

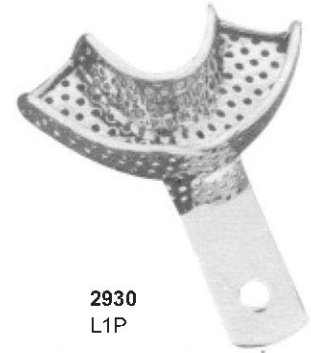

2930  
L1P



2932  
Adjustable  
Preforated



2933  
Adjustable  
Solid

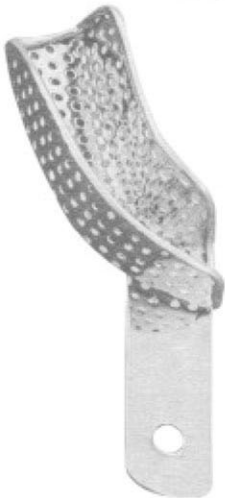

2931-A  
For upper right jaw  
For lower left jaw

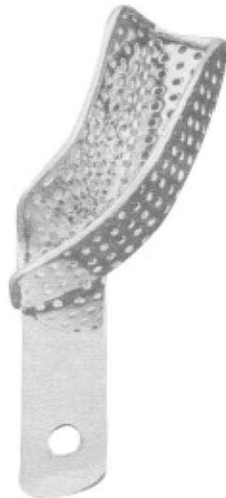

2932-B  
For upper left jaw  
For lower right jaw



2931-C  
For upper right jaw  
For lower left jaw



2931-D  
For upper left jaw  
For lower right jaw



Articulators



2934



2935



2936



2937



2939



2938



Articulators



2940



2941



2942



2943



2944



2945



2946



2947



Hollowares



**2957**  
Pilpectomy Tray



**2958**  
Sterilizing Box  
Available Sizes:



**2959**  
Endo Tray Box



**2960**  
Finger Cup



**2961**  
Bur Box



**2962**  
Sterilizing Vrum



**2963**  
Sterilizing Vrum



## Sterilizing Boxes & Instruments Trays



**2964**  
Instruments Box



**2965**  
Instruments Box



**2966**  
Instruments Box



**2967**  
Instruments Sterilizer  
150x75 mm



**2968**  
Endodontic Box



**2969**  
Sterilizer Box  
320x120 mm



**2970**  
Instruments Tray



**2971**  
Instruments Tray



**2972**  
Instruments Tray  
(Perforated)



**2973**  
Instruments Tray  
Shallow(Mayo)



**2974**  
Scaler Tray  
20.0 x 10.0 x 1.5 cm



**2975**  
Scaler Tray



**2976**  
Scaler Tray



Hollow wares







Hollow Wares



**2989**  
Sponge Bowl



**2990**  
Wash Basin  
300mm-350mm-400mm



**2994**  
Kick Bucket With Trolley



**2991**  
Sponge Bowl



**2992**  
Gallipot



**2993**  
Medicine Cup



**2995**  
Kidney Tray Shallow  
150mm-200mm-240mm-300mm



**2996**  
Kidney Tray without Lid  
150mm-200mm-240mm-300mm



**2997**  
Kidney Tray without Lid  
150mm-200mm-240mm-300mm

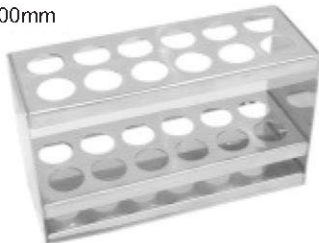

**2998**  
Tube Rack, Stainless Steel 18/10



**2999**  
Needle Case Ractangle  
Needle Case Round With Cover  
90x15



**3000**  
Dustbin Without Stand  
60-10-12 Ltr



**3001**  
Tube Rack, Round Model  
Stainless Steel 18/10



**3002**  
Dustbin Without Stand & Csp  
6-10-12 Ltr

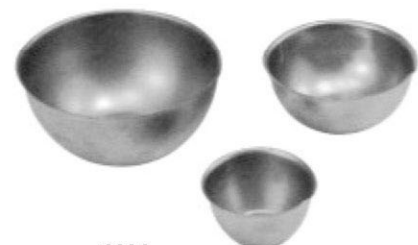

**3006**  
Lotion Bowl With Lip  
40-60-80-100-120-150-180-200mm



### Scissors With Tungsten Carbide Inserts



**3004**  
Standard



**3005**  
Standard



**3006**  
Standard



**3007**  
Standard

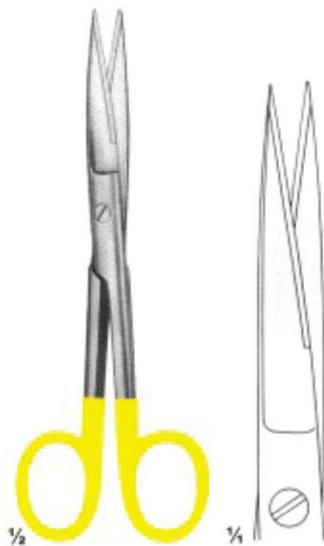

**3008**  
Standard



**3009**  
Standard



## Scissors With Tungststen Carbide Inserts

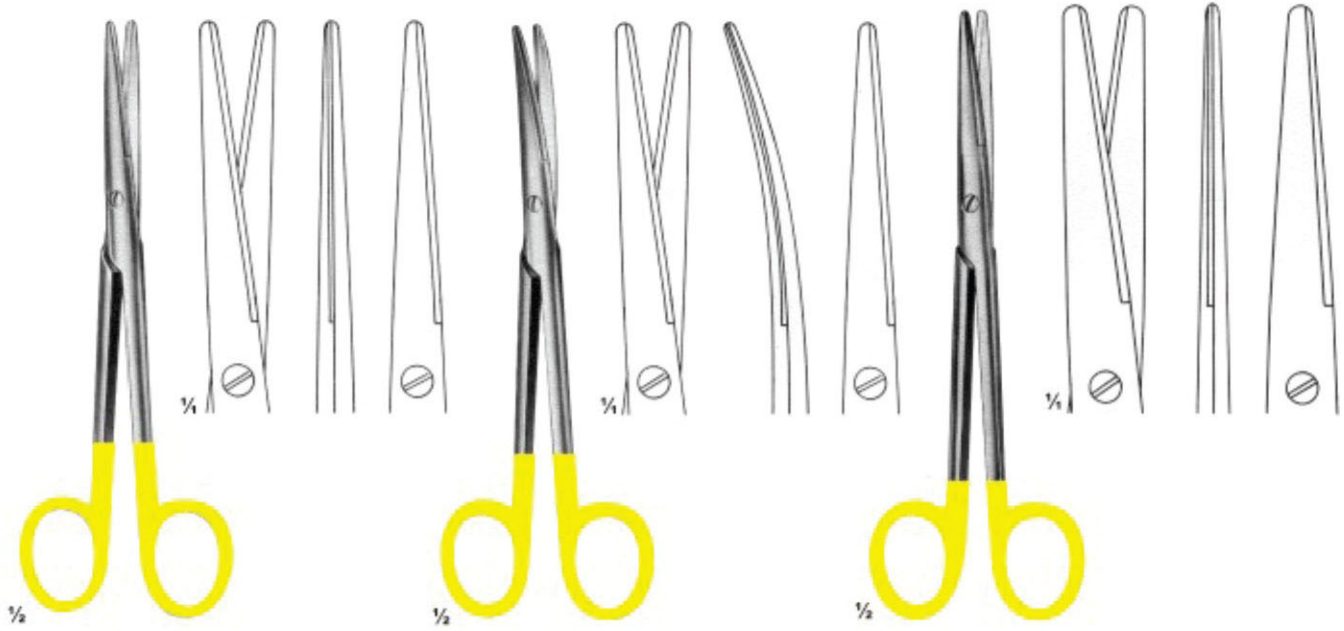

**3010**  
MAYO-LEXERX  
Straight  
16 cm

**3011**  
MAYO-LEXERX  
Curved  
16 cm

**3012**  
LEXERX  
Straight  
16,21 cm

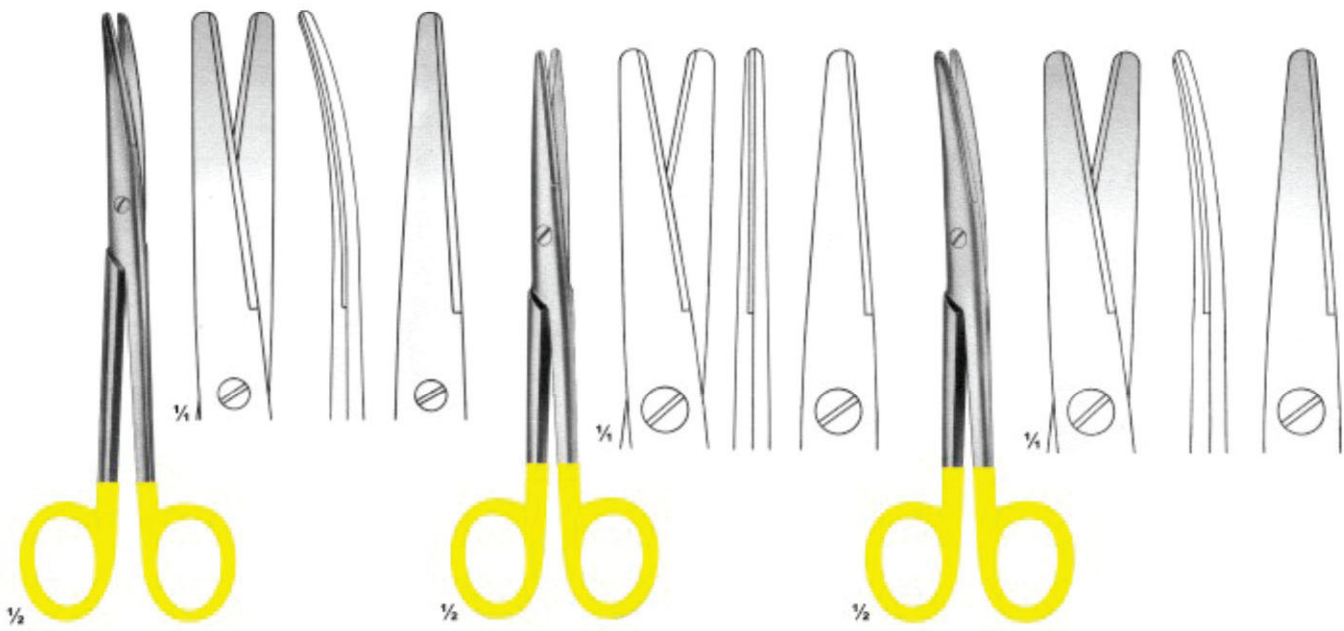

**3013**  
LEXERX  
Curved  
16,21 cm

**3014**  
MAYO-STILLE  
Straight  
15,17 cm

**3010**  
MAYO-STILLE  
Curved  
15,17 cm



## Scissors With Tungsten Carbide Inserts

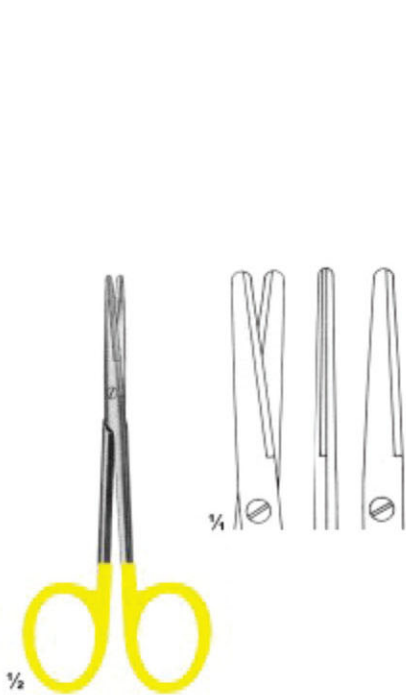

**3016**  
METZENBAUM  
Straight



**3017**  
METZENBAUM  
Curved

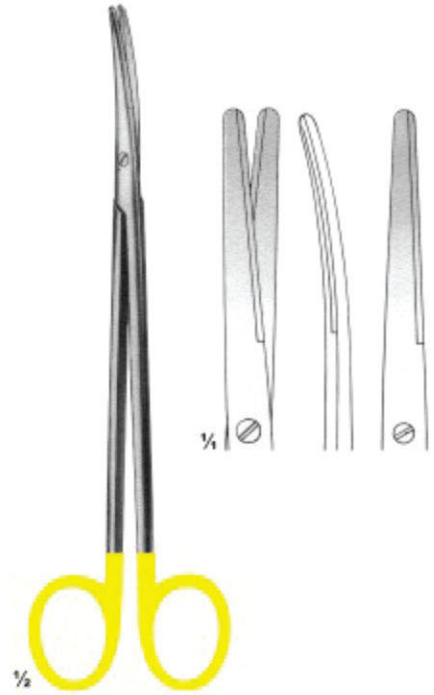

**3018**  
METZENBAUM  
Curved



**3019**  
METZENBAUM FINO  
Straight

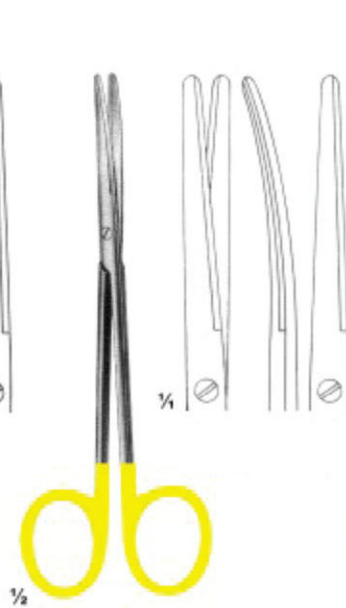

**3020**  
METZENBAUM FINO  
Curved

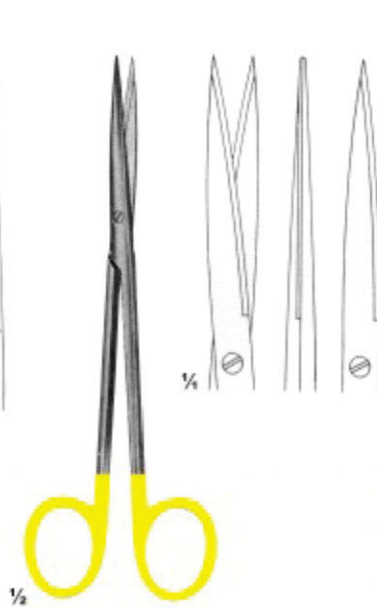

**3021**  
METZENBAUM FINO  
Sharp

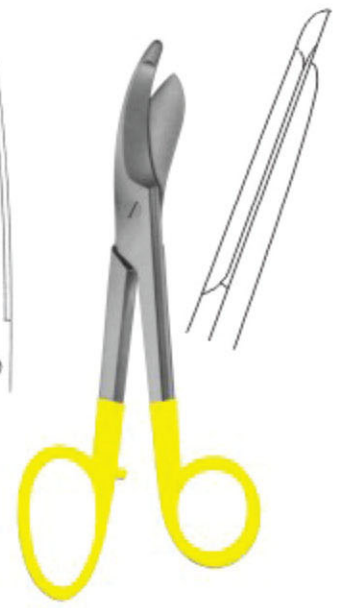

**3022**  
BRUND  
235 mm



## Scissors With Tungststen Carbide Inserts

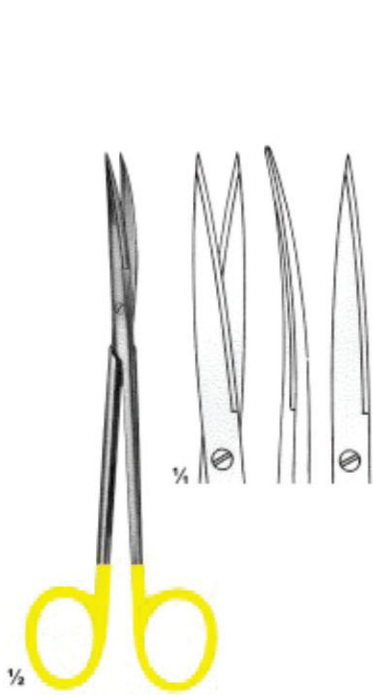

**3023**  
METZENBAUM FINO

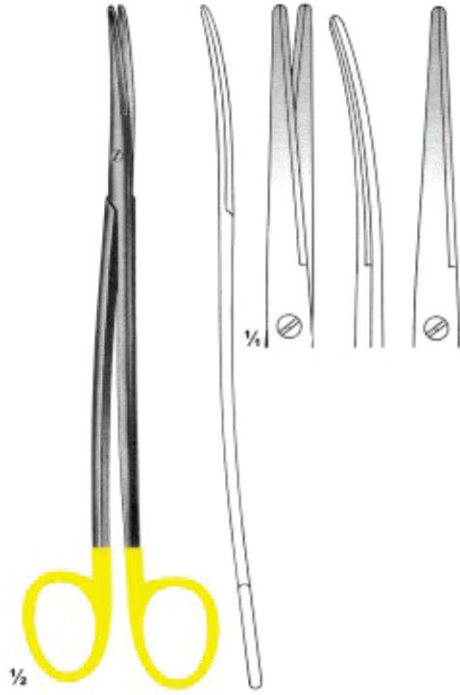

**3024**  
METZENBAUM FINO

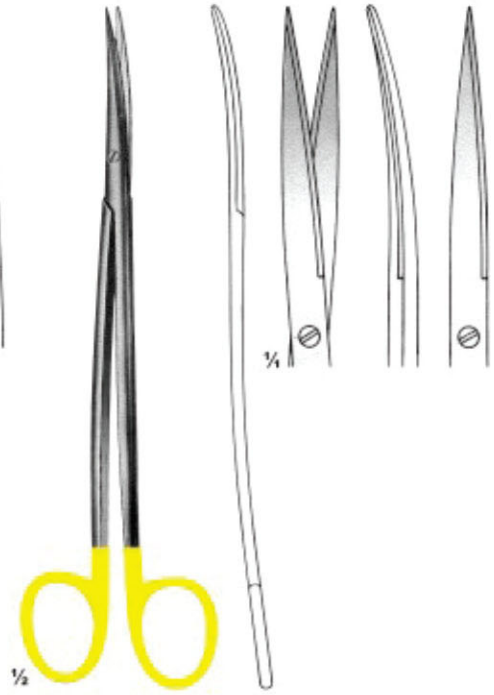

**3025**  
METZENBAUM FINO



**3026**  
METZENBAUM FINO

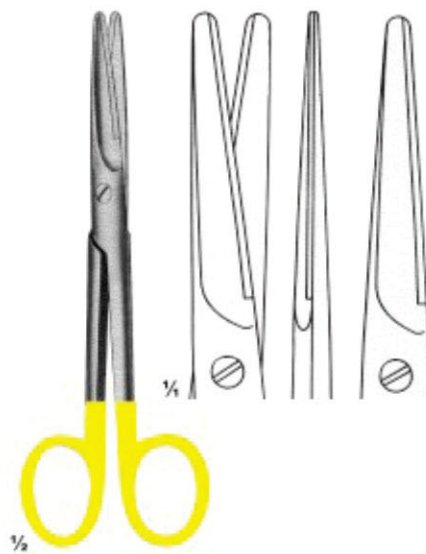

**3027**  
MAYO  
Straight

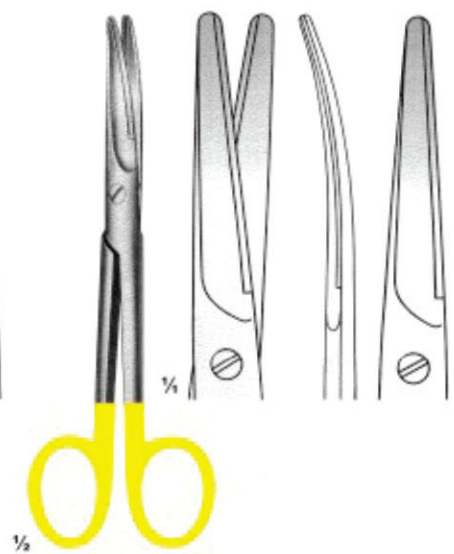

**3028**  
MAYO  
Curved



### Scissors With Tungsten Carbide Inserts



**3029**  
SIMS

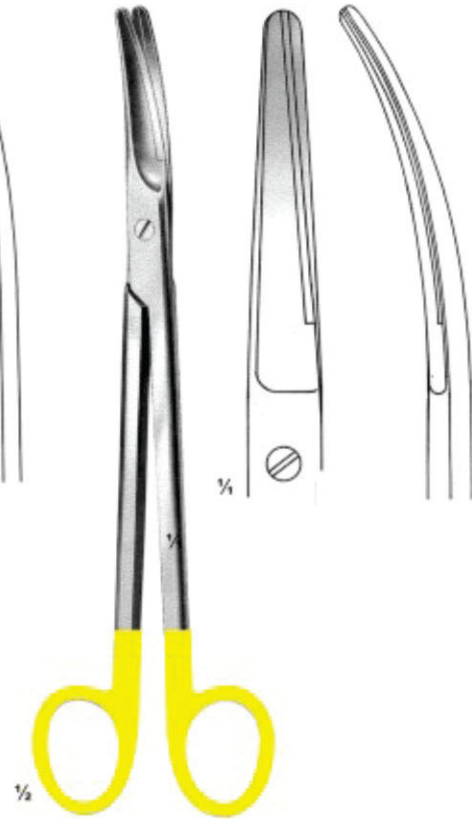
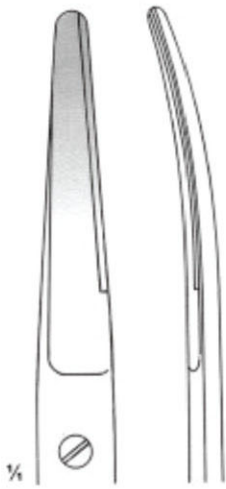

**3030**  
PARAMETERIUM

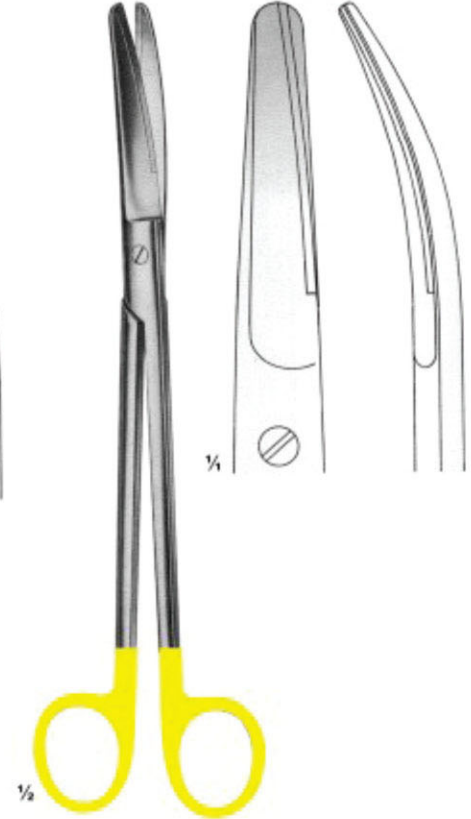

**3031**  
MAYO-HARRINGTON

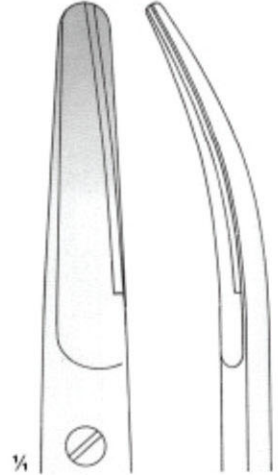

**3032**  
KELLY  
Straight 16 cm



**3033**  
KELLY  
Curved 16 cm



**3034**  
DEAN  
17 CM



**3035**  
LAGRANGE  
Double-Curved  
11.5 cm



Scissors With Tungstystem Carbide Inserts



3036  
DE-BAKEY



3037  
DE-BAKEY

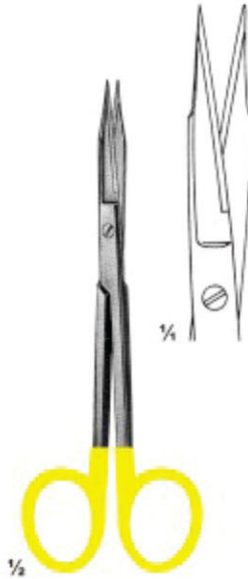

3038  
GOLDMAN FOX  
13 cm



3039  
GOLDMAN FOX  
Double-Curved  
13 cm

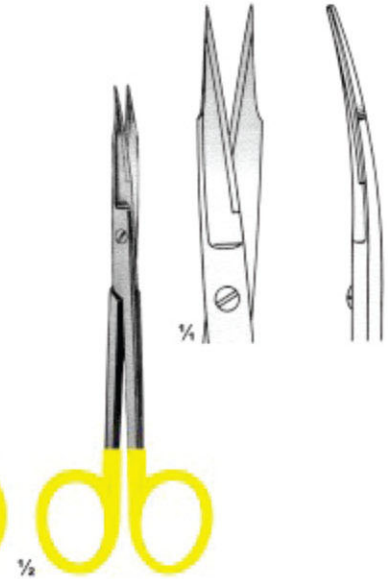

3040  
GOLDMAN FOX  
13 cm

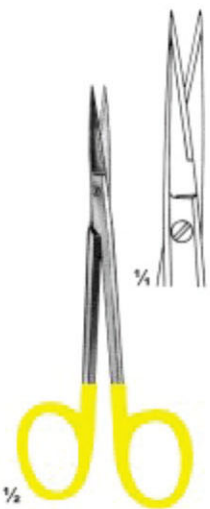

3041  
Fine Scissors  
Straight  
11,5 cm

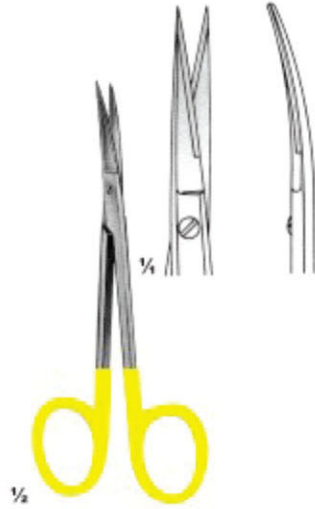

3042  
Fine Scissors  
Curved  
11,5 cm



3043  
Fine Scissors  
Angled  
11,5 cm

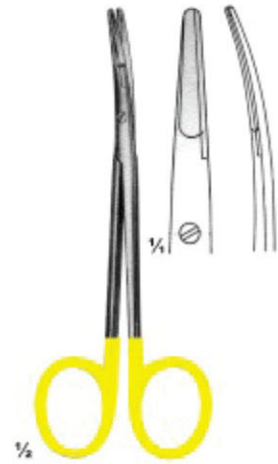

3044  
RAGNELL  
Curved  
12 cm



Scissors & Dissecting Forceps With Tungsten Carbide inserts

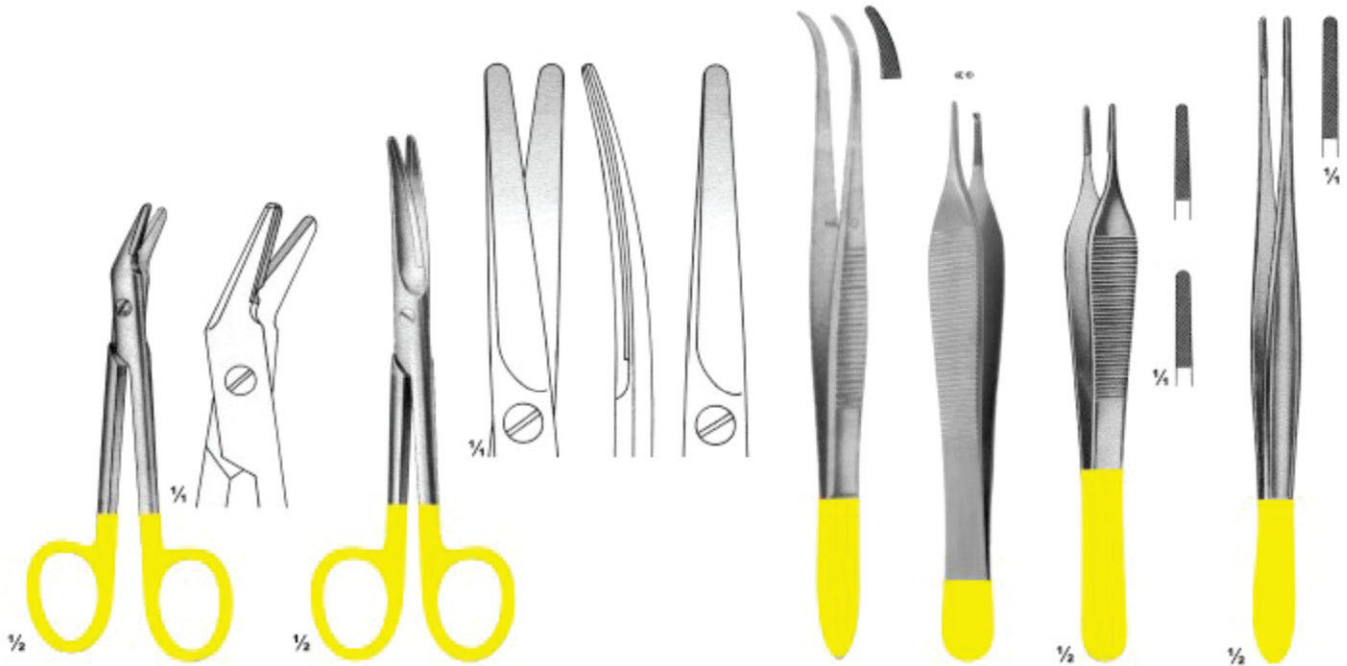

**3045**  
UNOVERSAL  
12cm

**3046**  
Lihature Scissors  
1 Black % 1 Goldplated ring

**3047**  
MERIAM  
16 cm

**3048**  
ADSON

**3049**  
ADSON

**3050**  
CUSHING  
17,5 cm

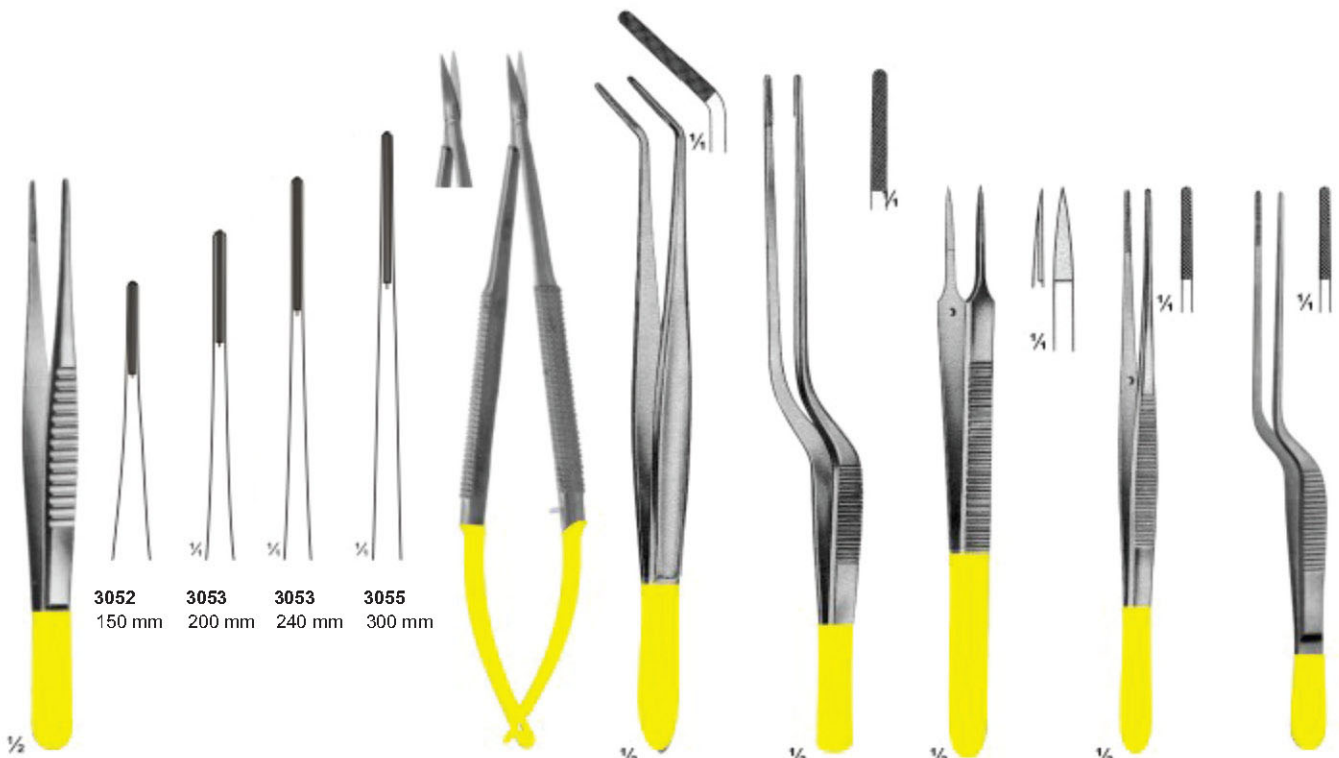

**3052** 150 mm  
**3053** 200 mm  
**3053** 240 mm  
**3055** 300 mm

**3051**  
DE BAKEY  
17,5 cm

**3056**  
CASTROVIEJO  
Curved  
15 cm

**3057**  
CUSHING  
18 cm

**3058**  
CUSHING-  
TAYLOR  
18 cm

**3059**  
Dressing  
Forceps  
15 cm

**3060**  
SEMKEN  
15 cm

**3061**





Dissecting Forceps & Needle Holders T.C Instruments

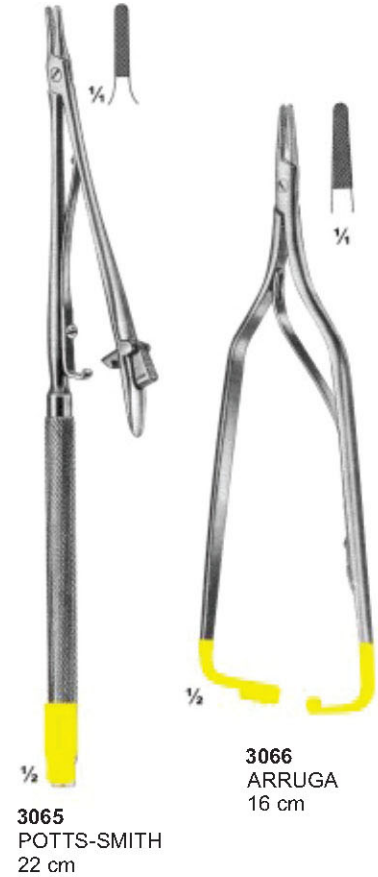
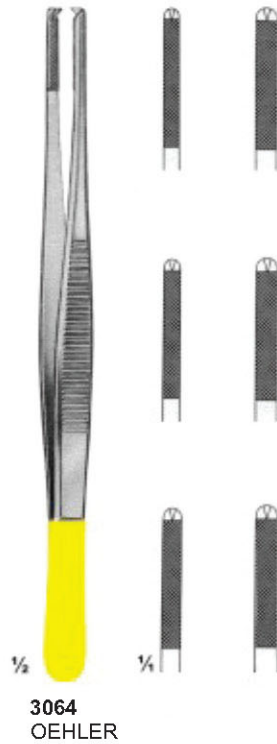
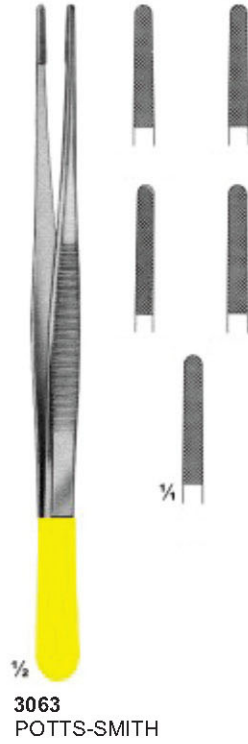



Needle Forceps With T.C. Inserts

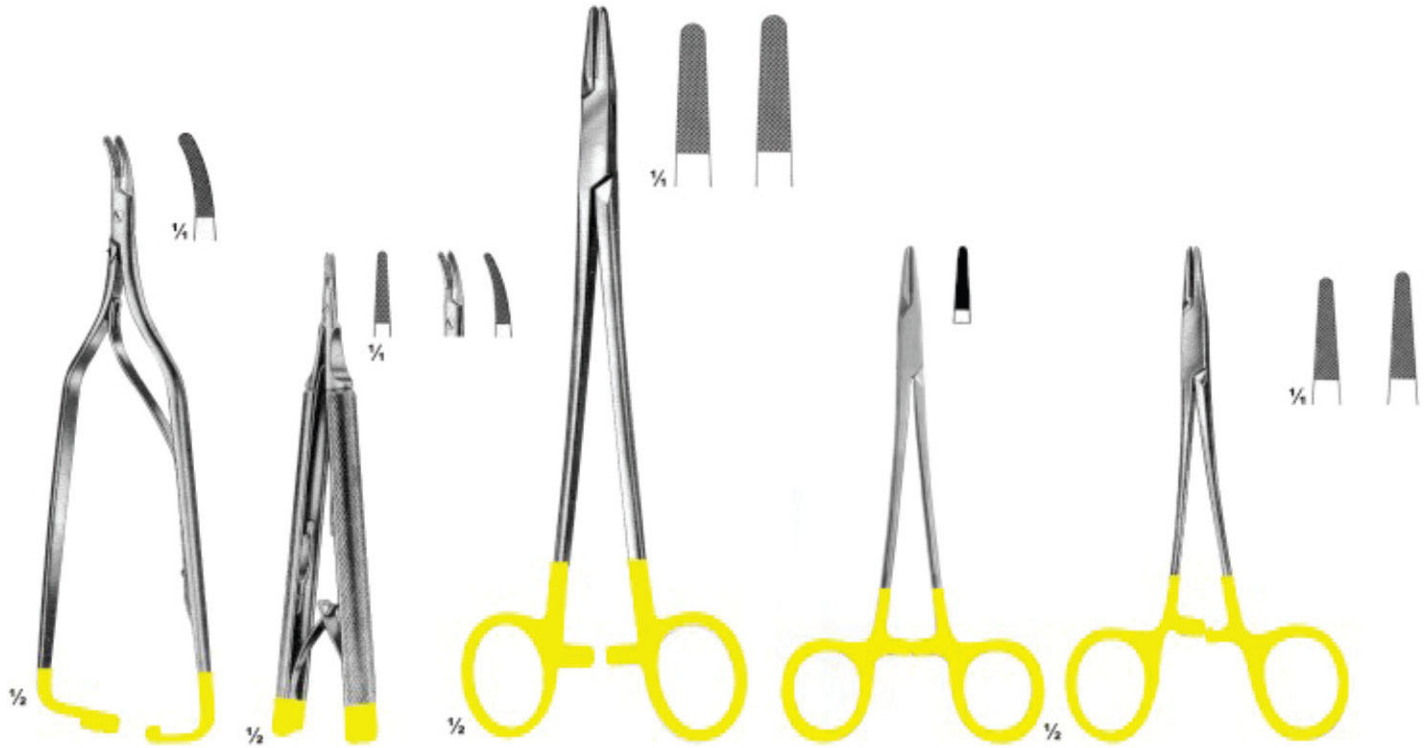

**3075**  
ARRUGA  
Curved  
16 cm

**3076**  
CASTROVIEJO  
13 cm

**3077**  
HEGAR  
20,24 cm

**3078**  
SMOOTH TIP  
15 cm

**3079**  
HALSEY  
13,15 cm

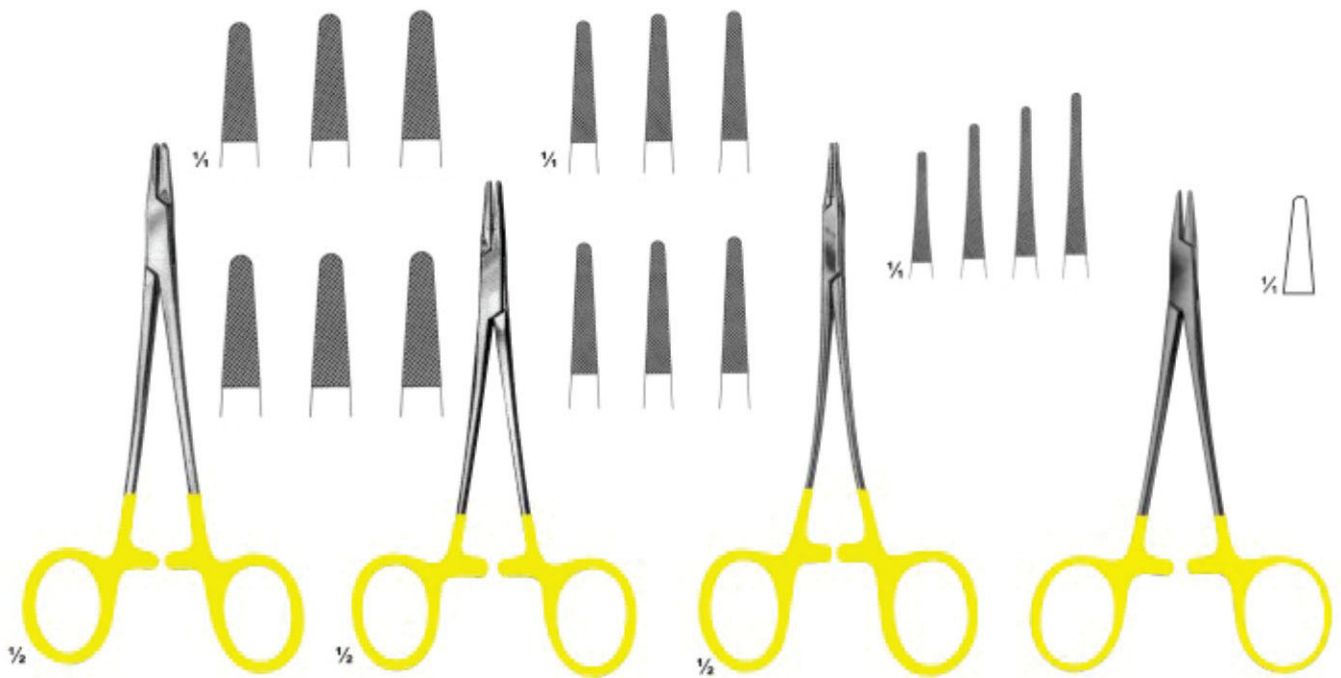

**3080**  
MAYO-HEGAR

**3081**  
DE BAKEY

**3082**  
HEGAR-VASCULAR

**3083**  
WEBSTER  
125 mm



# Needle Forceps With Tungsten Carbide Inserts

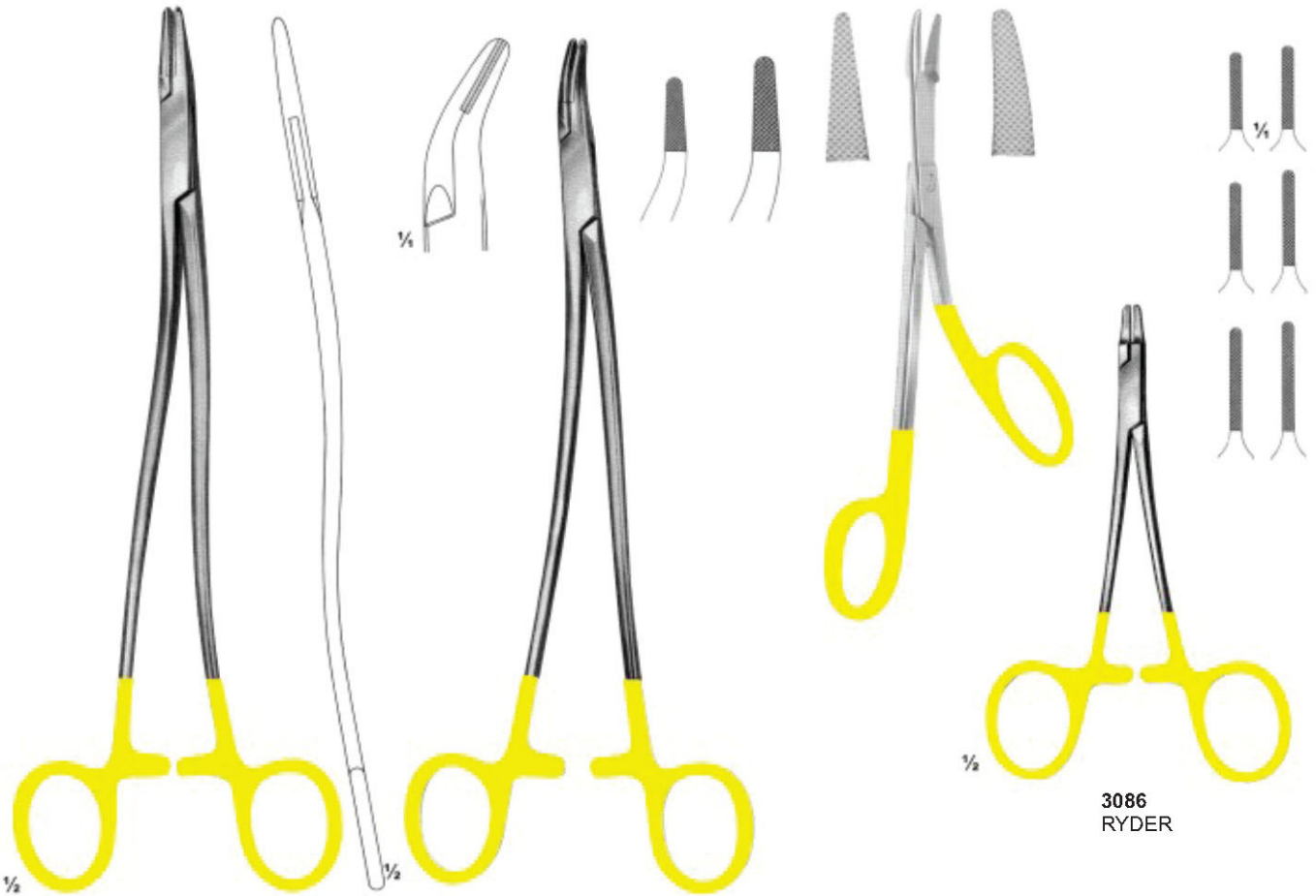

**3084**  
BOZEMANN-WERTHIEM  
20,24,26 cm

**3085**  
STRATTE

**3086**  
RYDER



**3087**  
RYDER-VASCULAR

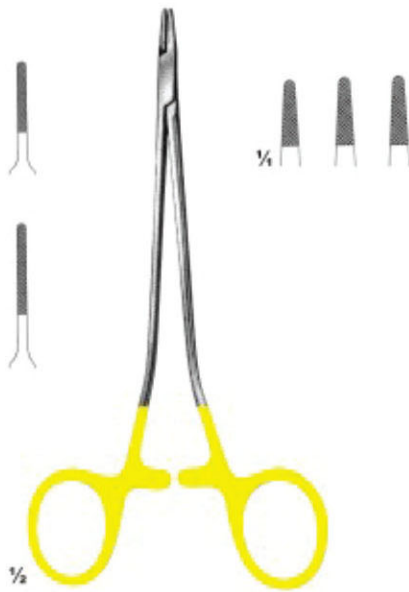

**3088**  
MARTIN

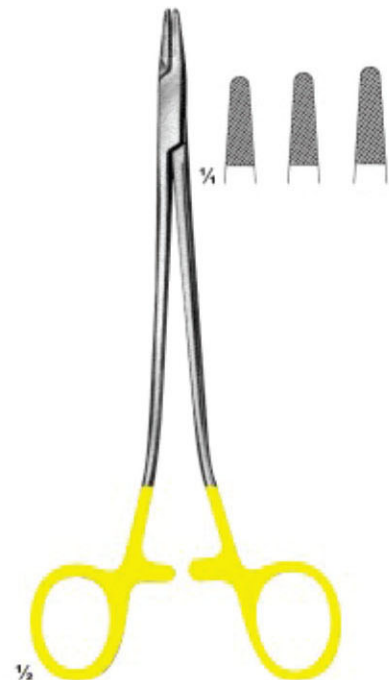

**3089**  
SAROT



Needle Forceps With Tungsten Carbide Inserts

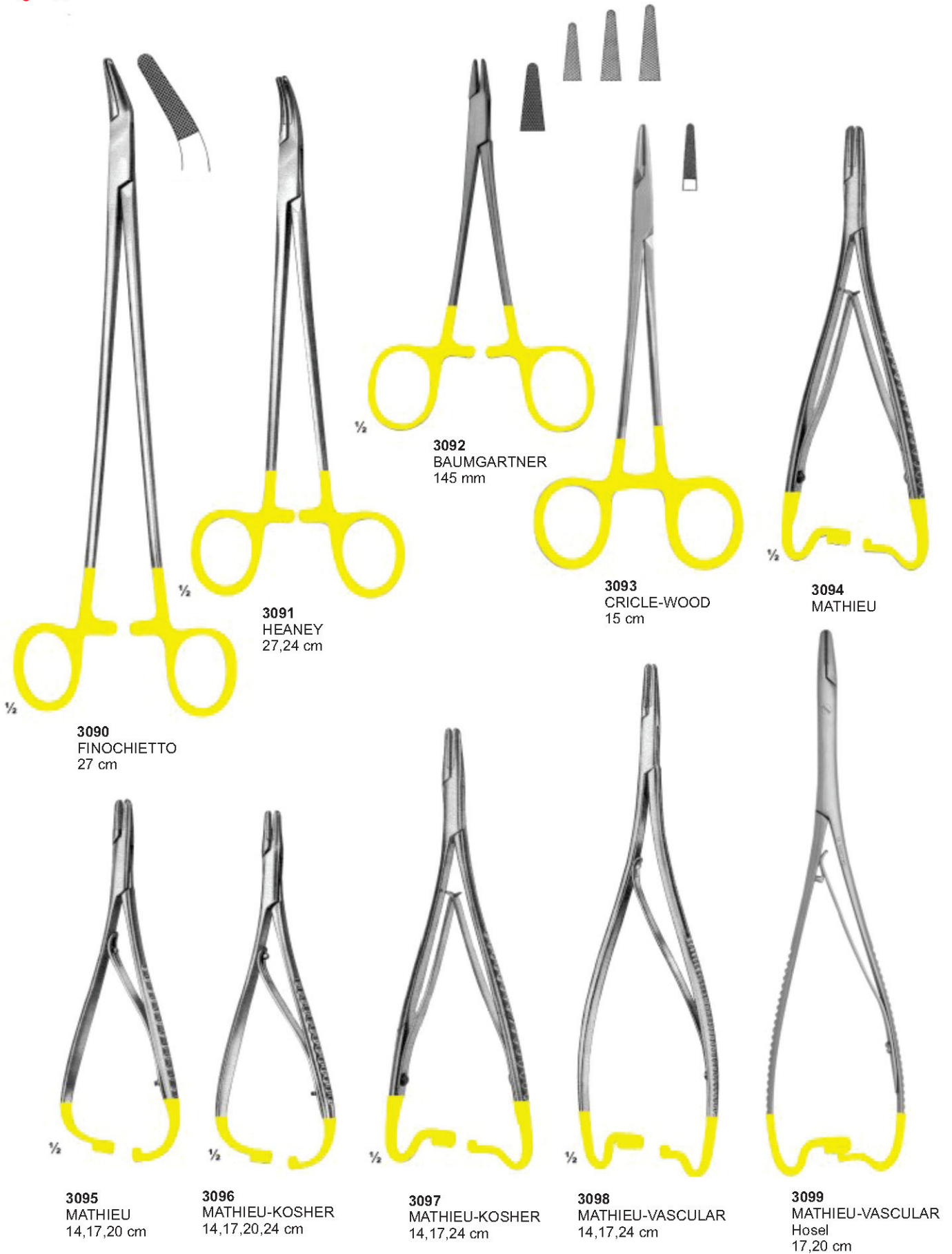



Needle Forceps With T.C.inserts



**3100**  
MATHIEU-RYDER  
17,20,24 cm

**3101**  
Hosel  
Curved  
20 cm

**3102**  
LICHTENBERG  
20 cm

**3103**  
LANGHALS  
20,25 cm

**3104**  
LICHTENBERG  
20,25 cm

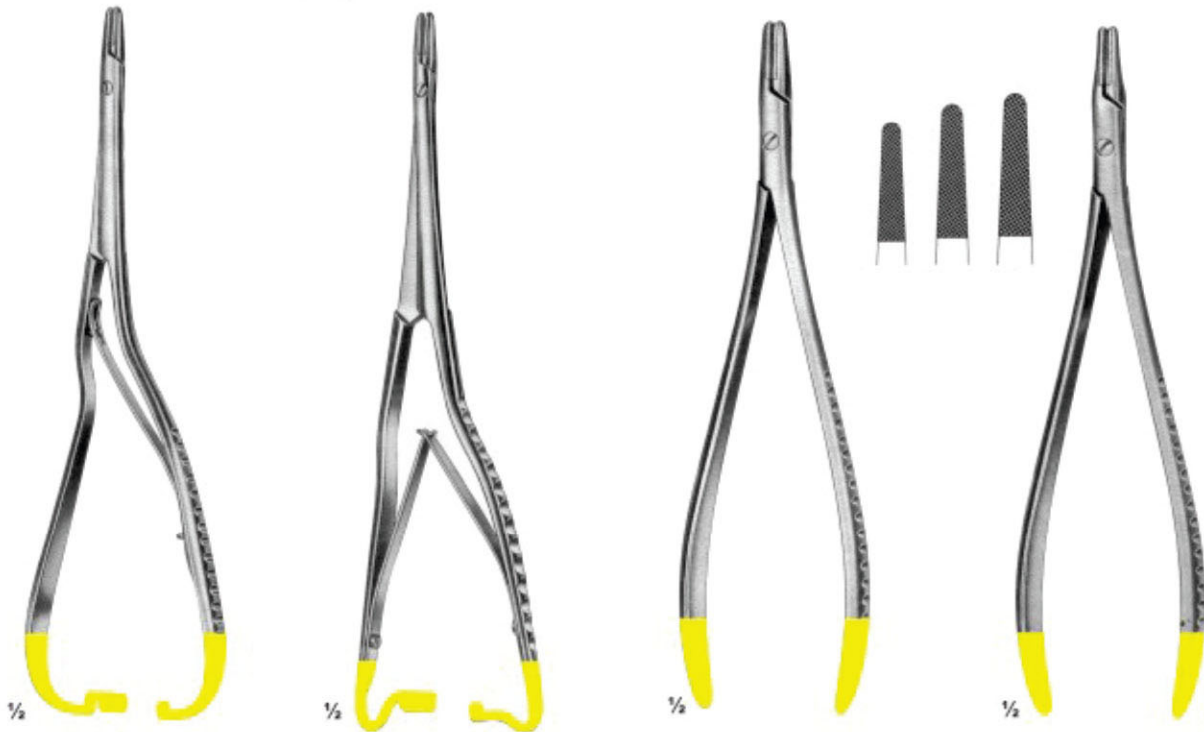

**3105**  
LUEHTY-BECK  
20,25 cm

**3106**  
LUEHTY-BECK  
20,25 cm

**3107**  
LANGENBECK  
18,20,23cm

**3108**  
LANGENBECK  
18,20,23cm



# Needle Cutting Plier With T.C. Inserts



**3109**  
TOENNIS  
Elastic pattern for  
dura-or intestinal suture  
180 mm



**3110**  
Cutting Plier  
12 cm

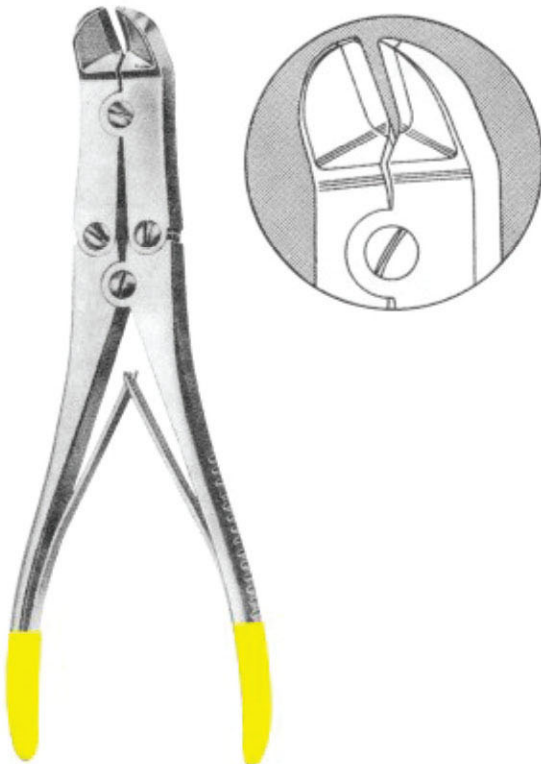

**3111**  
MULLAR CLAUS  
22 cm



**3112**  
Plier  
17.5 cm



## Alphabetical Index

### A

Adams, Pliers	174
Aderer, Pliers	174
Adson, Forceps	158,207
Adson, Tweezers	151
Ainsworth, Rubber Dam Punch	147
Albee	143
Albrecht, Tweezers	155
Allen, Tweezers	155
Allis, Tissue Forceps	158
Amalgam Applicators	97
Amalgam Condensers	97
Amalgam Pluggers	97
Amalgam Carriers	145
Amalgam Guns	145
Andresen, Pliers	175
Andrews, Tongue Depressor	160
Angle, Pliers	169,174
Apical, Elevator	57,63
Arruga, T.C. Needle Holder	208,209
Articulators	194-195
Aspirating Syringes	149
Allen 9A, Elevator	50

### B

Baby-Allis, Tissue Forceps	158
Band Removing Pliers	170
Bane, Rongeurs	179
Barnhart, Curettes	110,116
Barry, Elevator	66,69
Baum Gartner, Needle Holder	180,211
Bee Be, Scissors	186
Bein, Elevator	54,61
Beyer, Rongeurs	179
Bird Beak Pliers	167
Blumenthan, Rongeurs	176
Boley Gauge	143
Bone Curettes	129
Boynton, Needle Holder	181
Bozemann-Wertheim, T.C. Needle Holder	210
Bracket, Pliers	170
Brewer, Rubber Dam Instruments	147
Brown, Tissue Forceps	158
Brown-Adson, Tissue Forceps	158
Bruns, T.C. Scissors	203
Buchs, Retractor	162
Burnishers	99-100
Ball Chain	146
Boley Gauge,	143

Bone Gauge,	144
Bone Mill Forcep,	139
Bone Pluggers,	140
Bracket, Gauge	144
Buser, Elevator	52

### C

Carvers	102,103
Castroviejo, Needle Holder	181,208,209
Castroviejo, scissors	186
Castroviejo, Gauge	144
Castroviejo, Sclerer Marker	144
Cement Instruments	118,119,121
Cement Spatulas	120,122
Chisels	103
Chompret, Elevator	63
Cleveland, Rongeurs	177,178
College, Tweezers	152,154
Collier, Needle Holder	180
Collin, Retractor	162
Columbia, Curettes	110,111,116
Composite Placement	104,105
Con Scodellino, Wax Knives	126
Cord Packers	95
Cottle, Scissors	184
Coupland, Elevator	58
Crane-Kaplan	128
Crile, Forceps	157
Crile, Needle Holder	181
Crile-Wood, Needle Holder	180
Crown Instruments	135,136
Crown Removers	134,135
Crown Shell, Pliers	166
Cryer, Elevator	55,58,69
Cushing , T.C. Forceps	207
Cushing, Tweezers	151
Cushing-Taylor , T.C. Forceps	207

### D

De Bakey , T.C. Forceps	207
De Bakey, Scissors	184,186,206
De Bakey, T.C. Needle Holder	209
De La Rosa, Pliers	169
Deaver, Scissors	184
Denhart, Mouth Gag	160
Derf, Needle Holder	180
Disposable Products	117
Dr.Sader, Elevator	69
Dressing Forceps	207
Dean Scissors	186,205



## Alphabetical Index

### E

Elevators	51
Endodontic Condensers	86,87
Ernert, Wax Knives	126
Excavators	89-91
Explorers	80-82,91-94
Extracting forceps (American Pattern)	36-49
Extracting forceps (English Pattern)	1-24
Extracting forceps (fitting handle)	25-33
Extracting forceps (For Children)	34

### F

Fahnenstock, Wax Knives	126
Files	125
Filling Instruments	106,107
Fine, T.C. Scissors	206
Finochietto, T.C. Needle Holder	211
Finochietto, T.C. Needle Holder	211
Fischer, Pliers	175
Flagg, Tweezers	154
Flohr, Elevator	56
Fomon, Tissue Retractor	164
Freer, Elevator	52
Friedman, Rongeurs	178
Furrer, Pliers	174
Film Hanger	146
Finger Cup	197
Flohr, Elevator	57
Freer	15,16,
Elevator	52

### G

Gardner, Bone Chisels	132
Gardner, Needle Holder	180
Gardner, Rongeurs	178
Gillies, Hook	164
Gillies, Tweezers	151
Goldman Fox , T.C. Scissors	206
Goldman Fox, Curettes	112,113
Goldman Fox 14, Elevator	50
Goldman Fox, knives	114
Goslee, Pliers	175
Gracey Curettes	108,109,116

### H

Halsey, T.C. Needle Holder	209
Handles	72
Hartman, Rongeurs	179

Hatchets	95
Heaney, T.C. Needle Holder	211
Hegar, T.C. Needle Holder	209
Hegar-Vascular, T.C. Needle Holder	209
Heidbrink, Elevator	64,67,69
Heidbrink, Elevator	57
Howard 9H, Elevator	52
Height Gauge,	143
Hepp-Scheidle, T.C. Needle Holder	208
Hlsted-Mosquito, Forceps	159
Hoes	95,125
Hollow Wares	196-200
How, Pliers	167,174
Howard, Bone Files	131
Hylin, Elevator	61

### I

Implants Instruments	
Impression Trays	137-141
Iris Scissors	187-193
Ivory, Rubber Dam Instruments	183
	147

### J

Jarabak, Pliers	165
Jeseeph, Scissors	183
Johnson, Pliers	169,175
Joseph, Tissue Retractor	164

### K

Kalt, T.C. Needle Holder	208
Kelly, Forceps	159
Kelly, Scissors	183
Kelly Scissors	205
Kim's Plier	165
Kirkland, knife	114
Knives	125
Knowles, Scissors	184
Kocher, Retractor	162
Kocher-Langenbeck, Retractor	162
Kopp, Elevator	60,68
Kopp , Tweezers	151

### L

Lab & Office Pliers	166
Landgraf, Tweezers	154
Langenbeck, Pliers	175
Langenbeck, Retractor	162





## Alphabetical Index

Langenbeck, T.C. Needle Holder	212	Mini-Blumenthan, Rongeurs	176
Langer, Curettes	110,116	Molt, Elevator	50
Langhals, T.C. Needle Holder	212	Molt, Mouth Gag	160
Lecluse, Elevator	65	Molt 9, Elevator	50
Lessmann, Wax Knives	126	Morrison, Elevator	56
Lexer, T.C. Scissors	202	Mouth Mirrors with Handles	73
Lichtenberg, T.C. Needle Holder	212	MSY, Pliers	175
Ligature , T.C. Scissors	207	Mullar Claus, Wire Cutting Pliers T.C.	213
Lip & Cheek Retractors	161,162		
Lister, Scissors	184	<b>N</b>	
Littauer, Scissors	186	Nance, Pliers	168,169,174
Little, Scissors	184	Napkin Holders	146
Locklin, Scissors	186	Neivert, Needle Holder	180
London Hospital, Elevator	62	Nelson-Metzenbaum, Scissors	185
London-College, Tweezers	154,155	Non Chill	146
Lucae, T.C. Forceps			
Luehty-Beck, T.C. Needle Holder	212	<b>O</b>	
Lwanson, Crown Gauge	143	O'Brien, Pliers	168
Lagrange, Scissors	186,205	Obturation Instruments	88
Littaure, Scissors	186	Ochsenbein	128
Lwanson, Crown Gauge	143	Ordan, knife	114
		Oehler, T.C. Forceps	208
<b>M</b>		Olsen-Hegar, Needle Holder	180
Martin, T.C. Needle Holder	210	Optical Pliers	168
Mathieu, Needle Holder	181,211	Orthodontic Cutters, T.C.	172
Mathieu-Kosher, T.C. Needle Holder	211	Orthodontic Distal & Cutters	173
Mathieu-Ryder, T.C. Needle Holder	212	Orthodontic Pliers, T.C.	171
Mathieu-Vascular, T.C. Needle Holder	211	Ott, Elevator	62
Mayo Harrington, T.C. Scissors	205		
Mayo, Scissors	185,204	<b>P</b>	
Mayo-Hegar, Needle Holder	181	Parametrium, T.C. Scissors	205
Mayo-Hegar, T.C. Needle Holder	209	Partsch, Bone Chisels	133
Mayo-Lexer, T.C. Scissors	202	Partsch, Bone Mallet	133
Mayo-Stille, T.C. Scissors	202	Pean, Forceps	157
Mayo-Stille Scissors	185	Peeso, Pliers	166,175
Mc Kellops, Pliers	175	Peets, Forceps	157
Mccalls, Curettes	110,111,116	Perry, Tweezers	151
Mcindoe, Tweezers	151	P.K. Thomas,	96
Mead, Bone Mallets	133	Pich,	98
Mead, Elevator	64	Pluggers,	98
Mead, Rongeurs	179	Prichard, Elevator	50
Meriam , T.C. Forceps	207	Plastic Handle Elevators	70
Meriam, Tweezers	153,155	Polokoff, Bone File	131
Metzenbaum Fino, T.C. Scissors	203,204	Pott, Elevator	51
Metzenbaum, Scissors	185,203	Potts-Smith, T.C. Forceps	208
Micro Surgery Set	182	Potts-Smith, T.C. Needle Holder	208
Micro-Adson, Tweezers	151	Probes	82-85,91,94
Micro-Friedman, Rongeurs	178		
Middledorpf Retractor	162	<b>Q</b>	
Miller, Articulating Forceps	147	Quinby, Scissors	183
Miller, Bone Files	130		



## Alphabetical Index

### R

Ragnell , T.C. Scissors	206
Retainers, Bands	146
Reynolds, Pliers	169,174
Root Planning Curettes	115
Root splinter forceps	35
Roux, Retractor	162
Rubber Dam Clamps	148
Rubber Dam Holder	147
Rule, Curette	110
Russian, Tissue Forceps	158
Ryder, T.C. Needle Holder	210
Ryder-Vascular, T.C. Needle Holder	210

### S

Sarot, T.C. Needle Holder	210
Scalers	75-79
Scalpel Handles	71
Schwarz, Pliers	168,175
Schluger, File	114
Seldin, Elevator	50,55,67
Select, Tweezers	151
Semken, T.C. Forceps	207
Semkin, Tissue Forceps	158
Senn, Tissue Retractor	164
Separating Pliers	166
Sims, T.C. Scissors	205
Spatulas	123
Spencer, Scissors	186
Spencer-Wells, Forceps	157
Spreaders	87
Split Chisels,	128
Spring Bow Divider	143
Standard, T.C. Scissors	201
Standard, Tweezers	151
Steiner, Pliers	166
Sterilizing & Lab Instruments	156
Sterilizing Forceps,	163
Stevens, Needle Holder	181
Stevens, Scissors	183
Stille, Scissors	185
Stratte, T.C. Needle Holder	210
Strip Holder Clips	146
Syringes	150
Suction Tubes,	140,142
Sugarman, File	114

### T

Toennis, Wire Cutting Pliers T.C.	213
-----------------------------------	-----

Toennis-Adson, Scissors	184
Toennis, Tissue Retractor	164
Towel Clamps, Napkin Holders	159
Tweed, Pliers	168
Telescope, Crown Plier	136
Traymann, Crown Remover	128

### U

Universal , T.C. Scissors	207
Universal, Pliers	174
Universal, Elevator	135
Utility Plier	165

### V

Vernier, Measuring Instruments	143
Vernier Gauge	143

### W

Wakefield, Bone Chisels	132
Waldron, Pliers	174
Waldsachs, Pliers	174
Wangensteen, T.C. Forceps	208
Warwick-James, Elevator	62
Waugh, Tweezers	151
Wax & Modeling Carvers	120
Wax & Plaster Knives	127
Wax Carvers	101
Wax, Porcelain Instruments	118,119,121
Webster, Needle Holder	180,209
Weingart , Utility Pliers	167
Weitlaner, Retractor	160
West, Elevator	50
White, Rubber Dam Instrument	147
Wieder, Tongue Depressor	160
Winter, Elevator	65,69
Wire & Clasp Bending Pliers	170
Wire Bending Pliers	166
West, Elevator	50
Wire Cutter	165
Woodson,	98

### Y

Young, Pliers	168,174
---------------	---------

### Z

Zuricher, Measuring Instrument	143
Zuricher, Gauge	143

## **Venitex Surgical**

Small Industrial Estate

Sialkot-51310 Pakistan

Tel: 0092 52 3562929

Email: [info@venitexsurgical.com](mailto:info@venitexsurgical.com)

Email: [sales@venitexsurgical.com](mailto:sales@venitexsurgical.com)

Website: [www.venitexsurgical.com](http://www.venitexsurgical.com)